

CMP201A

Media Platform

User Guide









V1. 4-W

Revision History

Date	Version	Description	Author
28/4/2023	1.0	First Draft	RF
27/9/2023	1.1	Add Module CD2SDI-00	JY
30/1/2024	1.2	Update Safety Instructions	RF
20/3/2024	1.3	Fix some editing errors and format errors	JS
23/3/2024	1.4	Update the information of Appendix A-Power Consumption	SW

This guide contains some symbols to call your attention.

 DANGER	The DANGER symbol calls your attention to a situation that, if ignored, may cause physical harm to the user.
 CAUTION	The CAUTION symbol calls your attention to a situation that, if ignored, may cause damage to Our product.
 NOTE	The NOTE symbol calls your attention to important information.
 TIP	The TIP symbol calls your attention to additional information that, if followed, can make procedures more efficient.
 Red Arrow	The Red Arrow symbols point to import details mention the context above or below an image.
 Blue Arrow	The Blue Arrow symbol indicates the motion path of an item in an operation step.
 Thick Arrow	The thick Arrow symbol calls your attention to a series of operation steps mentioned in the context.

This guide also contains the following text conventions.

<i>Bold Italic</i>	The bold Italic text indicates a button to click, an item in the drop-down menu to select, or a certain item in the UI.
---------------------------	---

Safety Instructions

- Read these instructions
- Keep these instructions
- Follow all instructions
- Heed all warnings
- Do not use this unit near water.
- Only use a damp cloth to clean chassis
- Do not install near any heat sources such as radiators, heat registers, stoves, or other apparatus (including amplifiers) that produce heat
- Do not block any ventilation openings. Install in accordance with the manufacturer's instructions
- This unit is grounded through the power cord grounding conductor. To avoid electrocution, do not remove the power cord before the outlet is switched off or unplugged. If the plug does not fit into your outlet, consult an electrician for replacement of the outlet.
- Route power cords and other cables so that they are not likely to be damaged.
- Only use attachments/accessories specified by the manufacturer.
- Do not wear hand jewelry or watch when troubleshooting high current circuits.
- Do not work on the system during periods of lightning.
- Refer all servicing to qualified service personnel. Servicing is required when this unit has been damaged in any way.
- **Damage Requiring Service:** Unplug this product from the wall outlet and refer servicing to qualified service personnel under the following conditions:
 - When the power-supply cord or plug is damaged.
 - If liquid has been spilled, or objects have fallen into the product.
 - If the product has been exposed to rain or water.
 - If the product does not operate normally by following the operating instructions. Adjust only those controls that are covered by the operating instructions as an improper adjustment of the controls may result in damage and will often require extensive work by a qualified technician to restore the product to its normal operation.
 - If the product has been damaged in any way.

- **Replacement Parts:** When replacement parts are required, be sure the service technician uses replacement parts specified by the manufacturer. Unauthorized part substitutions made may result in fire, electric shock or other hazards.
- While user is upgrading the module/chassis, the devices could not be power off. Meanwhile, user's PC should have stable network connect to CMP while upgrading until it finishes. If the module could not finish the upgrade due to incidental interruption, there is a risk that the devices would be damaged and probably would be needed to send back to us for repairing.

Contents

1 Chassis Overview	6
1.1 Front Panel	6
1.2 Back Panel	7
2 Installation	8
2.1 Rack Installation	8
2.2 AC Power Connection.....	8
3 Module Overview	10
3.1 CMP201A Baseboard	10
3.2 Receiver Modules	10
3.3 Encoder Modules	11
3.4 Modulator Modules	12
3.5 Function Modules	14
3.6 Transcode Modules	15
3.7 Decode Module.....	15
4 Web GUI.....	16
4.1 Web GUI Overview	16
4.1.1 Connect the Management Port	16
4.1.2 Logging into the Web GUI.....	17
4.2 Status	17
4.3 System Setting.....	20
4.4 Input	24
4.5 Output.....	28
4.6 Admin	33

5 Module Configuration.....	34
5.1 Receiver Modules	34
5.1.1 CR2-DVBC-00	34
5.1.2 CR2-DVBC-01	38
5.1.3 CR2-DVBS2CI-01	38
5.1.4 CR2-DVBS2FTA-01/01A	39
5.1.5 CR2-8VSB-00.....	48
5.1.6 CR2-DVBT2CI-00	49
5.2 Encoder Modules.....	51
5.2.1 CE2-HDMI-00/R01	51
5.2.2 CE2-HDMI-02	59
5.2.3 CE2-HDMI-02C.....	64
5.2.4 CE2-HDMI-06B.....	68
5.2.5 CE2-SDI-01	71
5.2.6 CE2-CVBS-00.....	76
5.2.7 CE2-HDMI-R05/R05A.....	78
5.2.8 CE2-HDMI-06	86
5.3 Modulation Output modules	94
5.3.1 CM2-QAMA-R00.....	94
5.3.2 CM2-8VSB-03.....	98
5.3.3 CM2-QAMB-R00.....	100
5.3.4 CM2-DTMB-03.....	102
5.3.5 CM2-QAMA-03	105
5.3.6 CM2-OFDM-03	107
5.3.7 CM2-ISDBT-03	110

5.3.8 CM2-QAMB-02	112
5.3.8 CM2-QAMB-02	112
5.3.9 CM2-QAMA-R02.....	130
5.3.10 CM2-QAMA-R01/R01A.....	148
5.3.11 CM2-8VSB-R01/R01A	151
5.3.12 CM2-QAMB-R01/R01A.....	153
5.3.13 CM2-OFDM-R01/R01A.....	155
5.3.14 CM2-ISDBT-R01/R01A.....	157
5.4 Function modules	160
5.4.1 CP2-EAS-00	160
5.4.2 CP2-CAM-00	163
5.4.3 CP2-EIT-00.....	168
5.4.4 CP2-ASI-00	174
5.4.5 CP2-IP-00.....	179
5.4.6 CP-IP-02.....	235
5.5 Transcode Modules	243
5.5.1 CX-TXS-00	243
5.6 Decode Module.....	257
5.6.1 CD2-SDI-00	257
6 Appendices.....	267
Appendix A – Power Consumption	267
Appendix B – Abbreviations.....	269
Appendix C- Warranty	271
Appendix D- After-Sales Support.....	271

1 Chassis Overview

1.1 Front Panel

CMP201A is a new generation of compact media platform which focuses on cost-effective commercial TV market and traditional DTV market.

With powerful embedded Gigabit switch, optional commercial/broadcast level encoder modules and multi-mode receiver and modulator modules, it has been preconfigured to meet all the major video delivery requirements of signal receiving, descrambling, encoding, multiplexing, modulation and IP processing depending on a variety of models.

Due to its compact design, powerful functions, super practical price and low operational cost, it's a perfect choice for commercial video delivery applications for hotel, campus, hospital, MDU and more kinds of cable TV and IPTV systems, where massive programs are required to be processed, saving you more space and expense.



1. Cooling air intake
2. Status and Power Indicators and Reset button
3. RJ45 ports for remote network management
4. Two Gigabit Ethernet ports.

1.2 Back Panel

CMP201A



- I. 6 hot-swappable modules
- II. Single Power Supply
- III. Ground

2 Installation

2.1 Rack Installation

The CMP201A is designed to be mounted in a standard 19" rack. It takes 1RU of rack space. To install it into a rack, please use the following steps:

1. Determine the desired position in the rack for the CMP201A. Make sure that the air intake on the top of the unit and the exhausts on the back of the unit will not be blocked.
2. Install the brackets at desired position if there's no supporting plate in the rack.

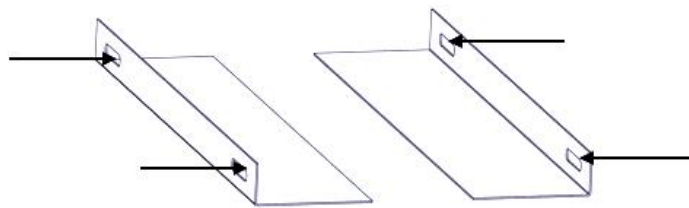

3. Insert the rack mount clips into place over the mounting holes in the rack.
4. Slide the CMP201A into the position in the rack.
5. Secure the chassis to the rack by installing the four supplied screws through the front mounting holes and tightening.

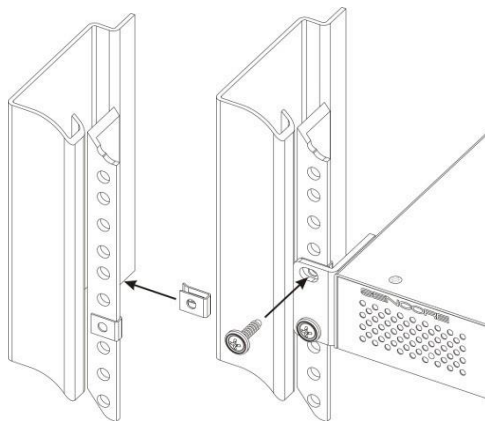

2.2 AC Power Connection

Please only use the supplied 3-prong power connector or one with equal specifications. NEVER tamper with or remove the grounding pin. This could cause damage to CMP201A, personnel, or property. Make sure the power outlet is switched off before plug or unplug the power cable from the panel of CMP201A.



When you take the equipment from a cold condition into a much warmer and humid condition, the equipment should be acclimated to the warm and humidity condition for at least 30 minutes. Powering up a non-acclimated unit may lead to shortcut or other damage to electronic components.



A professional UPS system is recommended for better performance of your content distribution system.

3 Module Overview

3.1 CMP201A Baseboard

CMP201A	Basic Function
Baseboard	120 inputs & 120 outputs IP channel

3.2 Receiver Modules

Module	Description
CR2-DVBC-00	<ul style="list-style-type: none"> 4 DVB-C Annex A/C or DTMB receive descrambling boards (one signal input interface, supporting signal internal looping, two CAM slots)
CR2-DVBC-01	<ul style="list-style-type: none"> 4-channel DVB-C Annex B or ISDBT receiver descrambling board (one signal input interface, support signal internal loop connection, two CAM slots)
CR2-DVBS2CI-01	<ul style="list-style-type: none"> 4-channel DVB-S2 receiving descrambling board (two DVB-S2 signal input interfaces, two CAM slots)
CR2-DVBS2FTA-01/01A	<ul style="list-style-type: none"> 4/8-channel DVB-S2/FTA receiving board (four DVB-S2 signal input interfaces, 4 LNB independent power supply, no CAM slot, with shield), support 64APSK (DVB-S2X)
CR2-8VSB-00	<ul style="list-style-type: none"> 4-channel 8VSB receiving module with 4 RF connectors
CR2-DVBT2CI-00	<ul style="list-style-type: none"> 4-channel DVB-T/T2 receiver board (one signal input interface, support signal internal loop, two CAM slots)

3.3 Encoder Modules

Module	Description
CE2-HDMI-00	<ul style="list-style-type: none"> 4-channel HDMI HD encoder (broadcast level), supports H.264 HD/SD, MPEG-2 SD, MPEG1L2, AAC (optional), AC3 (optional)
CE2-HDMI-02	<ul style="list-style-type: none"> 2-channel HDMI HD encoder, supports H.264/MPEG-2 HD/SD, MPEG1L2, AAC (support), AC3 (support), supports CC subtitles
CE2-HDMI-02C	<ul style="list-style-type: none"> 2-channel HDMI or component HD coding board, support H.264/MPEG-2 HD/SD, MPEG1L2 (support), AAC (support), AC3 (support), support CC subtitles and analog audio input
CE2-HDMI-06B	<ul style="list-style-type: none"> 4-channel HDMI HD encoding board (broadcast grade), support H.264 HD/SD, support B frame, MPEG1L2 (support), AAC (optional), AC3 (optional)
CE2-CVBS-00	<ul style="list-style-type: none"> 6-channel CVBS SD Coding Board (Broadcast Grade), Support H.264/MPEG-2 SD, MPEG1L2 (Fujitsu Chip)
CE2-CVBS-R01	<ul style="list-style-type: none"> 8-channel CVBS standard definition coding board (commercial grade), supporting H.264 SD, MPEG1L2, supporting superimposed OSD subtitles, station logos, and QR codes (HiSilicon chips)
CE2-SDI-01	<ul style="list-style-type: none"> 2-channel SDI HD coding board, support H.264/MPEG-2 HD/SD, MPEG1L2 (support), AAC (support), AC3 (support), support CC subtitles.
CE2-HDMI-R01A	<ul style="list-style-type: none"> 4-channel HDMI HD encoding board (commercial grade), support H.264 HD/SD, MPEG (supported), AC3 (optional), AAC (optional), support superimposed OSD subtitles, station logos, two-dimensional codes, do not support interlaced video signal input

CE2-HDMI-R05/R05A	<ul style="list-style-type: none"> 4-channel/8-channel HDMI HD coding board (commercial grade), support H.264/H.265 HD/SD (support up to 1080p60 input), MPEG1L2 (support), AAC (optional), AC3 (optional), support superimposed OSD subtitles, station logos, QR codes
CE2-HDMI-06	<ul style="list-style-type: none"> 4-channel HDMI HD encoding board (broadcast grade), support H.264 HD/SD, support B frame, MPEG1L2 (support), AAC (optional), AC3 (optional), support superimposed OSD subtitles, station logo, QR codes (Fujitsu chip)

3.4 Modulator Modules

Module	Description
CM2-QAMA-R00	<ul style="list-style-type: none"> 16-channel non-adjacent QAM-A/C modulation board.
CM2-QAMB-R00	<ul style="list-style-type: none"> 16-channel non-adjacent QAM-B modulation board.
CM2-DTMB-R01	<ul style="list-style-type: none"> (4G DDR) 4-channel adjacent frequency DTMB modulation board
CM2-DTMB-R01A	<ul style="list-style-type: none"> (4G DDR) 8-channel adjacent frequency DTMB modulation board
CM2-QAMB-R01	<ul style="list-style-type: none"> (4G DDR) 4-channel adjacent frequency QAM-B modulation board
CM2-QAMB-R01A	<ul style="list-style-type: none"> (4G DDR) 8-channel adjacent frequency QAM-B modulation board
CM2-OFDM-R01	<ul style="list-style-type: none"> (4G DDR) 4-channel adjacent frequency OFDM modulation board
CM2-OFDM-R01A	<ul style="list-style-type: none"> (4G DDR) 8-channel adjacent frequency QAM-B modulation board

CM2-ISDBT-R01	<ul style="list-style-type: none">• (4G DDR) 4-channel adjacent frequency ISDBT modulation board
CM2-ISDBT-R01A	<ul style="list-style-type: none">• (4G DDR) 8-channel adjacent frequency ISDBT modulation board
CM2-8VSB-R01	<ul style="list-style-type: none">• (4G DDR) 4-channel adjacent frequency 8VSB modulation board
CM2-8VSB-R01A	<ul style="list-style-type: none">• (4G DDR) 8-channel adjacent frequency 8VSB modulation board
CM2-DTMB-03	<ul style="list-style-type: none">• 8-channels of adjacent frequency DTMB modulating board
CM2-QAMA-03	<ul style="list-style-type: none">• 8-channels of adjacent frequency QAM-A/C modulating board
CM2-QAMB-03	<ul style="list-style-type: none">• 8-channels of adjacent frequency QAM-B modulating board
CM2-OFDM-03	<ul style="list-style-type: none">• 8-channels of adjacent frequency OFDM modulating board
CM2-ISDBT-03	<ul style="list-style-type: none">• 8 channels of adjacent frequency ISDBT-T modulating board
CM2-8VSB-03	<ul style="list-style-type: none">• 8 channels of adjacent frequency 8VSB(ATSC) modulating board
CM2-QAMA-02	<ul style="list-style-type: none">• 16 QAM-A modulation modules, 2 Gigabit IP input electrical ports, single port 512 inputs; 1 CAS interface (RJ45), support scrambling function (enabled by default); 1 RF output interface, support 16 QAM-A non-frequency modulation outputs, independent constellation mode configuration
CM2-QAMB-02	<ul style="list-style-type: none">• 16 QAM-B modulation modules, 2 Gigabit IP input ports, single port 512 inputs; 1 CAS interface (RJ45), support scrambling function (not enabled by default, additional authorization is required); 1 RF output interface, support 16 QAM-B non-frequency modulation outputs, independent

	constellation mode configuration
CM2-QAMA-02A	<ul style="list-style-type: none"> 32 QAM-A modulation modules, 2 Gigabit IP input electrical ports, single port 512 inputs; 1 CAS interface (RJ45), support scrambling function (enabled by default); 1 RF output interface, support 32 QAM-A non-frequency modulation outputs, independent constellation mode configuration.
CM2-QAMB-02A	<ul style="list-style-type: none"> 32 QAM-B modulation modules, 2 Gigabit IP input ports, single port 512 inputs; 1 CAS interface (RJ45), support scrambling function (not enabled by default, additional authorization is required); 1 RF output interface, support 32 QAM-B non-frequency modulation outputs, independent constellation mode configuration

3.5 Function Modules

Module	Description
CP2-EAS-00	<ul style="list-style-type: none"> EAS signal processing module, support analog and digital EAS signal triggering, MPEG1L2 (support), AAC (support), AC3 (support)
CP2-CAM-00	<ul style="list-style-type: none"> CI descrambling processing module, 2 independent CI card slots, compatible with mainstream CAM cards, support mainstream CAS decryption
CP2-EIT-00	<ul style="list-style-type: none"> EIT multiplexing module supports 32 TS inputs and 16 TS outputs
CP2-ASI-00	<ul style="list-style-type: none"> 5 ASI modules, default 3 ASI inputs and 2 ASI outputs (each port input and output can be set)

CP2-IP-00	<ul style="list-style-type: none"> IP protocol conversion module, 3 x Gigabit Ethernet ports (1 input and 2 output), 1 x HDMI, 1 x USB, support UDP/RTP/HLS/SRT protocol interconversion
CP2-IP-02	<ul style="list-style-type: none"> Gigabit IP multiplexing processing module, with 2 RJ45 Gigabit ports, supports UDP/RTP protocol, and supports a maximum of 120 inputs and 120 outputs per port.
CP2-IP-02-SFP	<ul style="list-style-type: none"> Gigabit IP multiplexing processing module, with 2 SFP Gigabit ports, supports UDP/RTP protocol, and supports a maximum of 120 inputs and 120 outputs per port.

3.6 Transcode Modules

CX2-TXS-00	<ul style="list-style-type: none"> Transcoding module, 2 Gigabit Ethernet ports, supports 1-channel H.265/H264 4K to HD or 5-channel H.265/H.264 HD transcoding or 6-channel H.264/MPEG-2 HD transcoding.
------------	--

3.7 Decode Module

Module	Description
CD2-SDI-00	<ul style="list-style-type: none"> 4-channel HD/SD SDI decoding and output board

4 Web GUI

4.1 Web GUI Overview

4.1.1 Connect the Management Port

Factory network settings of the Management Port:

- IP address 192.168.1.10
- Subnet Mask 255.255.255.0
- Gateway 192.168.1.254

Take the following steps to access the Web GUI in a browser.

- Connect laptop/computer to CMP201A management port directly.
- Set the IP address of the laptop/computer in the same network segment with the CMP201ABaseboard. CMP201A will occupy up to 7 IP addresses if it's fully loaded as each module has its own IP address including the baseboard. ***Please avoid possible IP address conflict between management PC and CMP201A unit.***
- Check the physical connection by ping command.

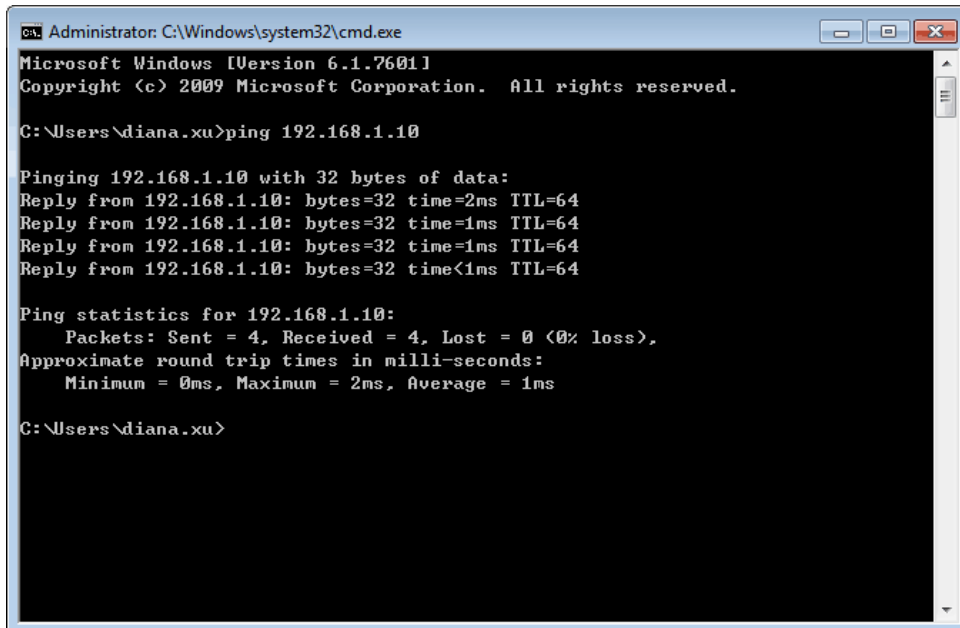

```
Administrator: C:\Windows\system32\cmd.exe
Microsoft Windows [Version 6.1.7601]
Copyright (c) 2009 Microsoft Corporation. All rights reserved.

C:\Users\diana.xu>ping 192.168.1.10

Pinging 192.168.1.10 with 32 bytes of data:
Reply from 192.168.1.10: bytes=32 time=2ms TTL=64
Reply from 192.168.1.10: bytes=32 time=1ms TTL=64
Reply from 192.168.1.10: bytes=32 time=1ms TTL=64
Reply from 192.168.1.10: bytes=32 time<1ms TTL=64

Ping statistics for 192.168.1.10:
    Packets: Sent = 4, Received = 4, Lost = 0 (0% loss),
    Approximate round trip times in milli-seconds:
        Minimum = 0ms, Maximum = 2ms, Average = 1ms

C:\Users\diana.xu>
```



CMP201A has an embedded gigabit switch inside the chassis. You can use it as a switch with other devices together. The four network ports are respectively used for managing and streaming.

From left to right, port 1 and port 2 are used for management, port 3 and port 4 are used for data transmission. A good method of checking IP output is to play the IP streams using VLC player directly.



If you want to connect a switch between CMP201A and PC or other devices, this switch should support IGMP V2 and IGMP snooping function. If the switch you used is not configured properly, it could cause some network issue.

4.1.2 Logging into the Web GUI

Enter the CMP201A Baseboard IP address into the URL field of any recommended Web browsers (IE8 or above, Firefox, and Google Chrome) to access the login page. The default user name and password are both admin. Click **Login** to log into the GUI.

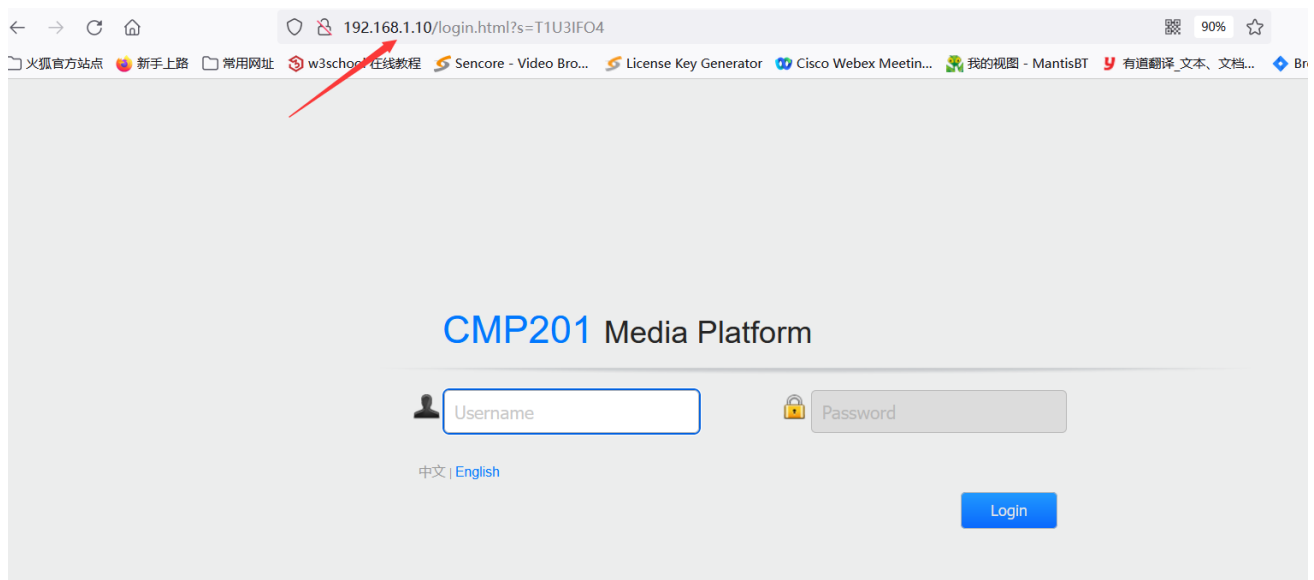



4.2 Status

Status>Device status

After a successful login, you will always enter the status overview page, where you can check the device status of:

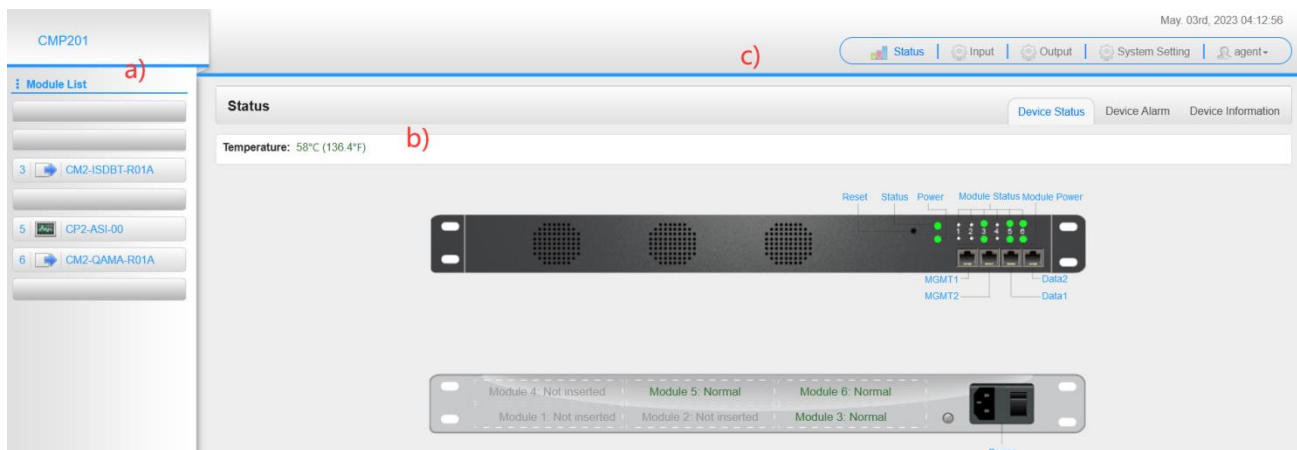
- Module List: it shows the module(s) inserted
- Device host operating status, running status of fans and other status display options
- Menu Bar and time display



 We use only IE, Firefox and Chrome for testing procedures. If you use other browsers, like Microsoft Edge, you may encounter incomplete UI layouts, and configure setting in these browsers may lead to errors.

Status>Device Alarm

Device Alarm page shows the alarm settings and alarm record.

Name	Location	Alarm Type	Last Changed
Input unlock	Backboard Channel: 45	Input TSIP	2022/07/19 20:27:28
Input unlock	Backboard Channel: 44	Input TSIP	2022/07/19 20:27:28
Input unlock	Backboard Channel: 43	Input TSIP	2022/07/19 20:27:28
Input unlock	Backboard Channel: 42	Input TSIP	2022/07/19 20:27:28
Input unlock	Backboard Channel: 41	Input TSIP	2022/07/19 20:27:28
Input unlock	Backboard Channel: 40	Input TSIP	2022/07/19 20:27:28
Input unlock	Backboard Channel: 39	Input TSIP	2022/07/19 20:27:28
Input unlock	Backboard Channel: 38	Input TSIP	2022/07/19 20:27:28
Input unlock	Backboard Channel: 37	Input TSIP	2022/07/19 20:27:28
Input unlock	Backboard Channel: 36	Input TSIP	2022/07/19 20:27:28
Input unlock	Backboard Channel: 35	Input TSIP	2022/07/19 20:27:27
Input unlock	Backboard Channel: 34	Input TSIP	2022/07/19 20:27:27
Input unlock	Backboard Channel: 33	Input TSIP	2022/07/19 20:27:27
Input unlock	Backboard Channel: 32	Input TSIP	2022/07/19 20:27:27
Input unlock	Backboard Channel: 31	Input TSIP	2022/07/19 20:27:27
Input unlock	Backboard Channel: 30	Input TSIP	2022/07/19 20:27:27
Input unlock	Backboard Channel: 29	Input TSIP	2022/07/19 20:27:27
Input unlock	Backboard Channel: 28	Input TSIP	2022/07/19 20:27:27
Input unlock	Backboard Channel: 27	Input TSIP	2022/07/19 20:27:27
Input unlock	Backboard Channel: 26	Input TSIP	2022/07/19 20:27:27
Input unlock	Backboard Channel: 25	Input TSIP	2022/07/19 20:27:27
Input unlock	Backboard Channel: 24	Input TSIP	2022/07/19 20:27:27
Input unlock	Backboard Channel: 23	Input TSIP	2022/07/19 20:27:27
Input unlock	Backboard Channel: 22	Input TSIP	2022/07/19 20:27:27
Input unlock	Backboard Channel: 21	Input TSIP	2022/07/19 20:27:27

Status>Device alarm>Alarm Settings

Alarm setting lets the user set the alarms, logs, SNMP Trap, and different alarm parameters the user wants to see.

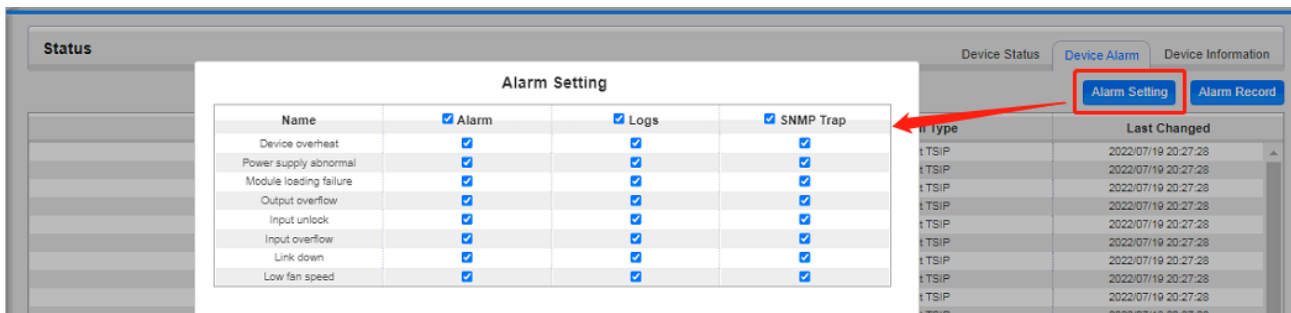

Status>Device alarm>Alarm Record

Alarm Record lets the user see the name of the alarm, the location, if it is still active, and the last time it was changed.

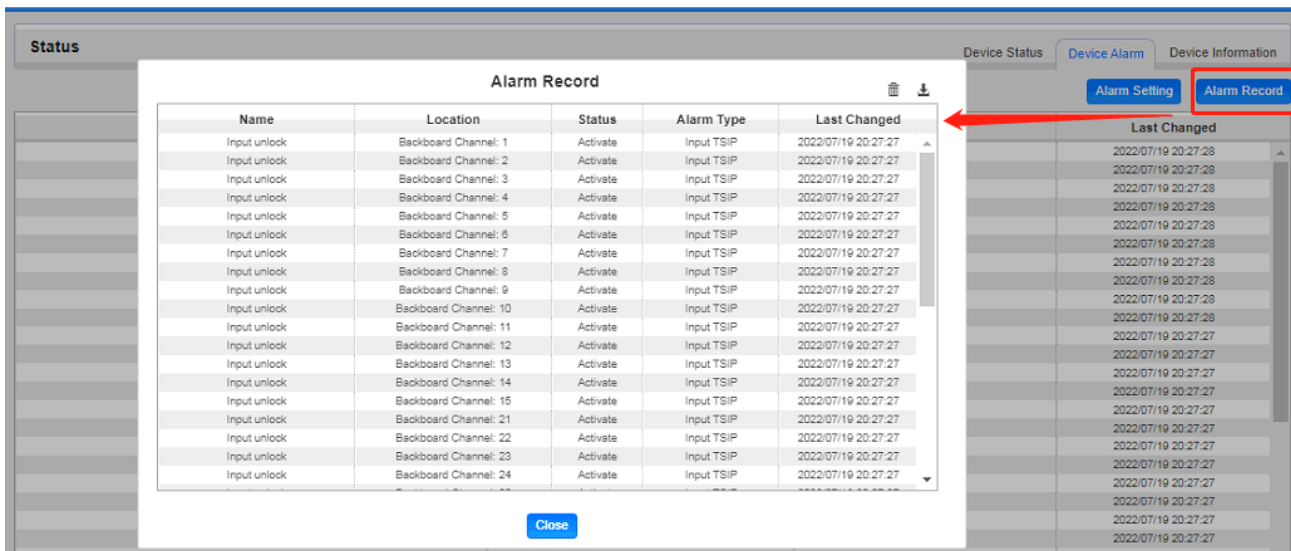

Status>Device Information

Device Information page shows the firmware version, software version, and hardware version of baseboard and each inserted module.

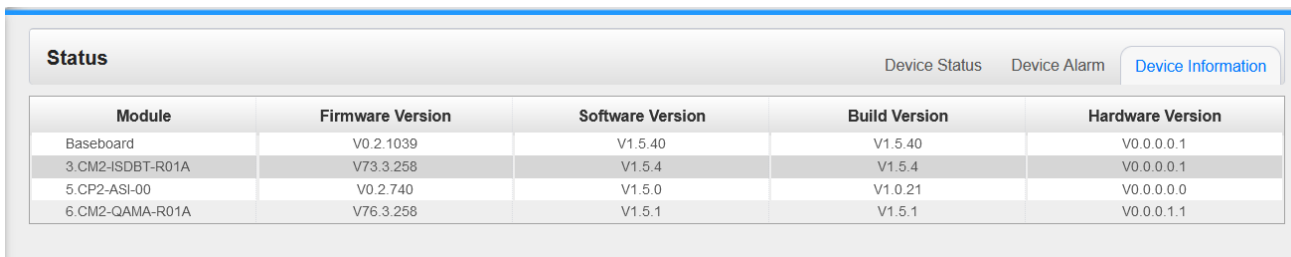

4.3 System Setting

Click the **System Setting** on the top right corner to enter the system setting page where you can find **Network, Time Setting, System Manage, Password, NMS Register, Advanced Setting, and SNMP**

System Setting> Network

In **Network** page you can assign a static IP address to CMP201A's baseboard. Click the **Apply** button on the right side to make the change take effect.

Module Name	IP Address	Subnet Mask	Default Gateway	DNS Server IP	MAC Address
NMS	192.168.1.10	255.255.255.0	192.168.1.254	0.0.0.0	A0:69:86:07:26:E6
DATA	192.168.2.140	255.255.255.0	192.168.2.1	0.0.0.0	A0:69:86:07:26:E5

Tips

1. When the subnet of the internal Baseboard IP address is changed, the IP addresses of all the modules will follow the subnet change automatically.
2. The IP addresses of all the modules will be automatically set to follow-on immediately after the Baseboard address.
3. IMPORTANT: To avoid IP address conflicts, ensure that all the IP addresses assigned within the chassis (Baseboard and Modules) are not used elsewhere in the network.



Note to avoid IP conflict when you set the baseboard IP address. The occupied IP section will be displayed in this page on the top blue area.

System Setting> Time

In **Time** page you can see the current system time, change **Time Zone**, choose system time **Mode** (Manual or Automatic), enable/disable **Auto Sync** and modify **NTP Server Address** in Automatic mode or change the current system **Time** in Manual mode. Click the **Apply** button on the right side to make the change take effect.

- **Automatic** mode

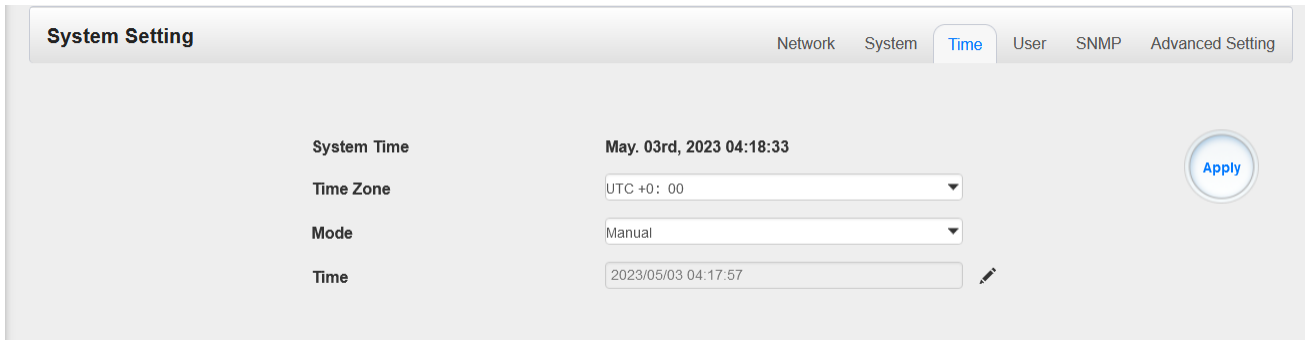

- **Manual mode**

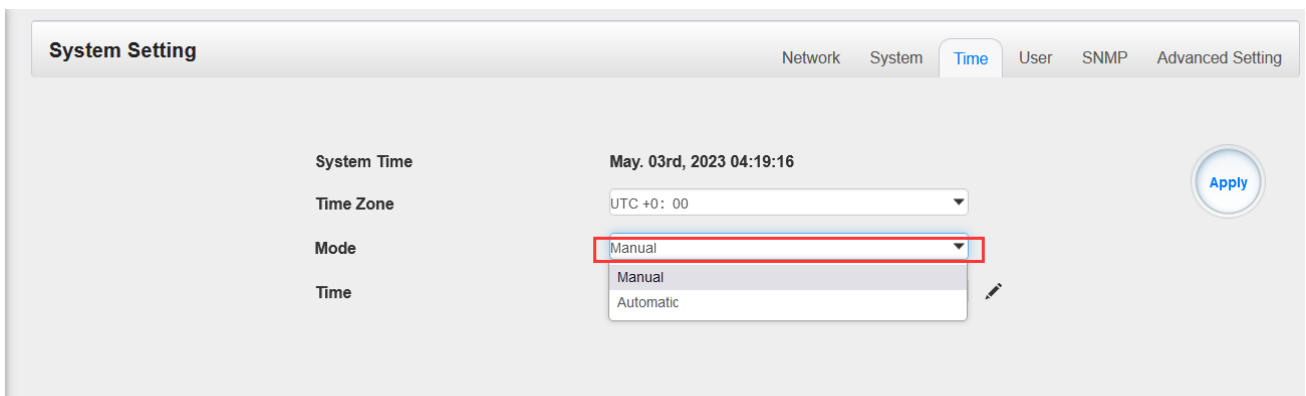

System Setting>System

In **System** page you can do an upgrade, import or export configuration, import or export license (only for baseboard), reboot the whole unit, restore it to factory setting (only for baseboard), set SNMP MIB, export log and clear log (only for baseboard).

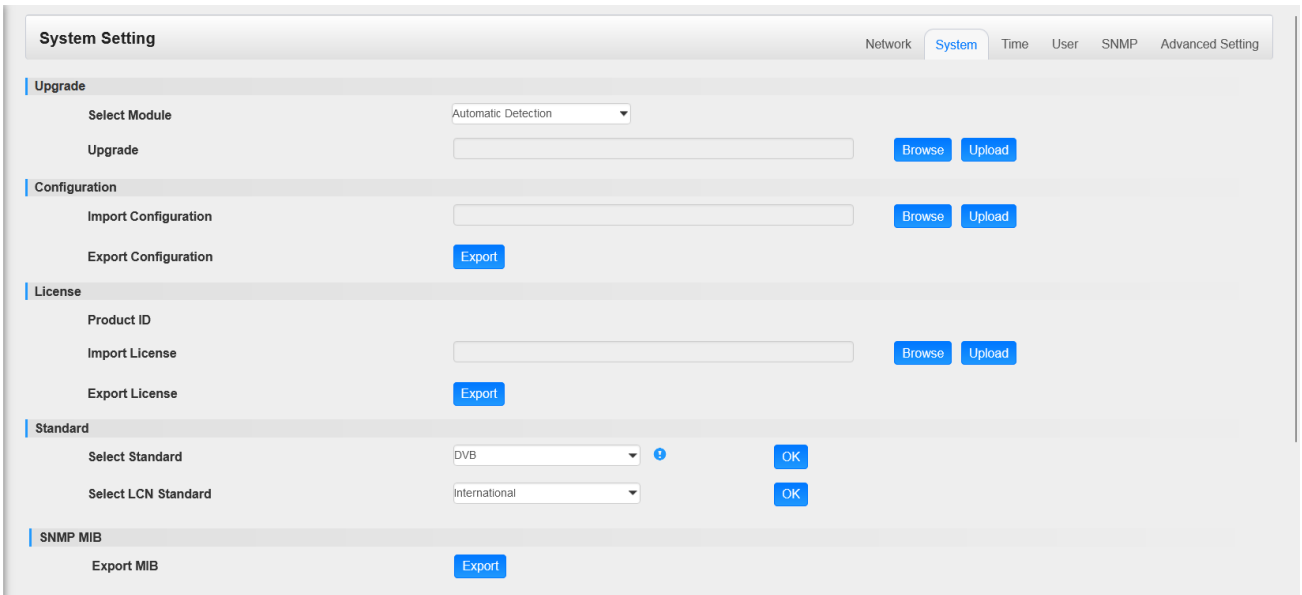

System Setting> User

In **User** page you can reset login password.

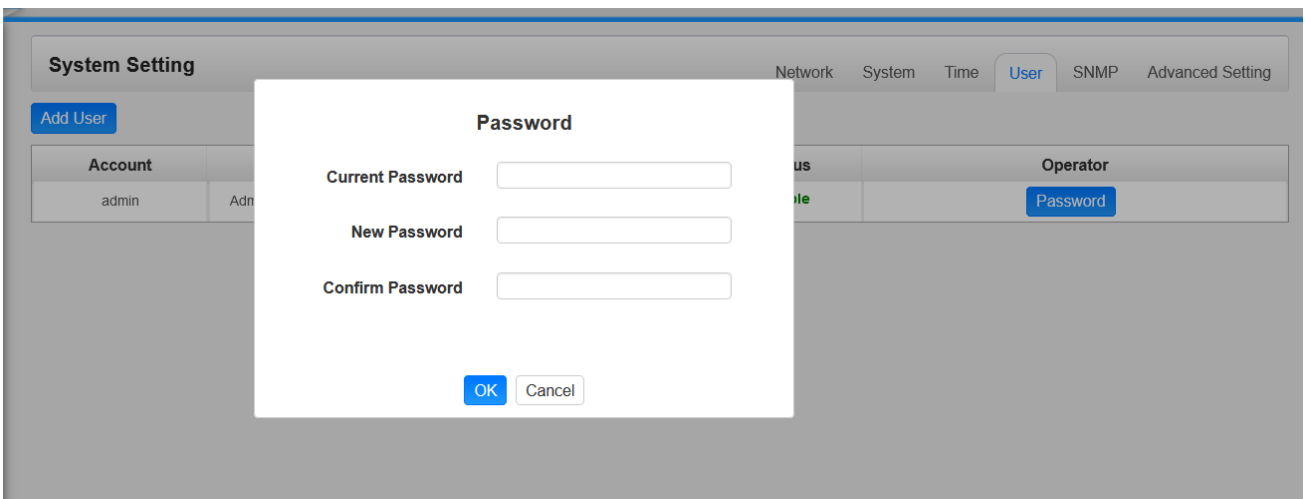

System Setting> SNMP

In **SNMP Setting** page you can SNMP traps addresses.

System Setting Network System Time User **SNMP** Advanced Setting

SNMP:	<input type="text" value="Enable"/>	
Trap IP Address1 (IPv4):	<input type="text" value="0.0.0.0"/>	Enable: <input type="checkbox"/>
Trap IP Address1 (IPv6):	<input type="text" value="2001::c0a8:1af"/>	Enable: <input type="checkbox"/>
Trap IP Address2 (IPv4):	<input type="text" value="0.0.0.0"/>	Enable: <input type="checkbox"/>
Trap IP Address2 (IPv6):	<input type="text" value="2001::c0a8:1ae"/>	Enable: <input type="checkbox"/>
Read-Only Community:	<input type="text" value="public"/>	
Read-Write Community:	<input type="text" value="private"/>	

[Apply](#)

System Setting > Advanced Setting

In **Advanced Setting** page you can do some changes about standard, priority, Language, Authorized Use Time, Destination Module Number, Reverse Proxy, CA Descriptor, PAT Sync Update, PAT Version, reboot the Switch Module.

System Setting Network System Time User SNMP **Advanced Setting**

Standard	<input type="text" value="DVB"/>	?
Priority Encoding	<input type="text" value="Auto"/>	?
Language	<input type="text" value="English"/>	
Authorized Use Time	<input type="text" value="Stay With First Level Authorized Time"/>	<input type="text" value="Never expires"/> ?
Destination Module Number	<input type="text" value="4"/>	?
Reverse Proxy Enable	<input type="text" value="Enable"/>	?
CA Descriptor Filter	<input type="text" value="Disable"/>	?
PAT Sync Update	<input type="text" value="Disable"/>	?
PAT Version	<input type="text" value="Disable"/> <input type="text" value="0"/>	?
VLAN Enable	<input type="text" value="Enable"/>	?
ARP VLAN Tag	<input type="text" value="2"/>	?
SSH/Telnet	<input type="text" value="Enable"/>	?
Reboot Switch Module	Reboot Switch Module	

[Apply](#)

4.4 Input



Click the **IP Input** on the top line to go into IP input page where you can see **Status**, **Basic Setting**, **IGMP Setting** and **Service Configuration**.

Input > **Status**

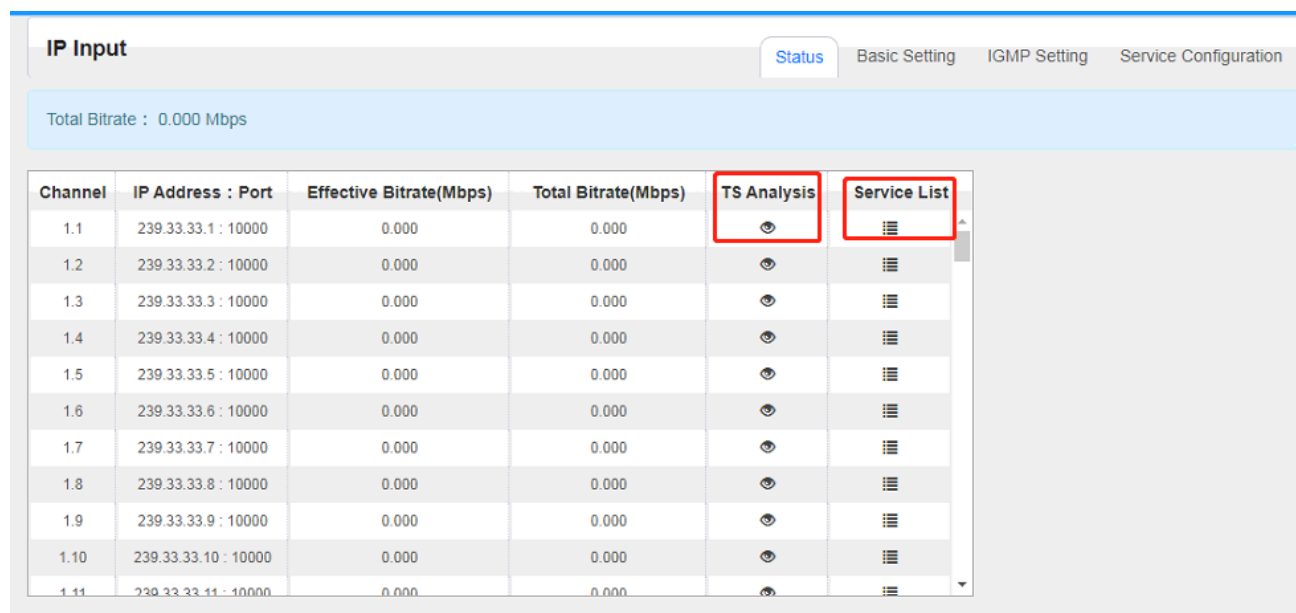
In this page, you can check Total bitrate, each channel Total Bit Rate, IP Address and Port, Effective Bit Rate, TS Analysis and Service List.



Channel	IP Address : Port	Effective Bitrate(Mbps)	Total Bitrate(Mbps)	TS Analysis	Service List
1.1	239.33.33.1 : 10000	0.000	0.000		
1.2	239.33.33.2 : 10000	0.000	0.000		
1.3	239.33.33.3 : 10000	0.000	0.000		
1.4	239.33.33.4 : 10000	0.000	0.000		
1.5	239.33.33.5 : 10000	0.000	0.000		
1.6	239.33.33.6 : 10000	0.000	0.000		
1.7	239.33.33.7 : 10000	0.000	0.000		
1.8	239.33.33.8 : 10000	0.000	0.000		
1.9	239.33.33.9 : 10000	0.000	0.000		
1.10	239.33.33.10 : 10000	0.000	0.000		
1.11	239.33.33.11 : 10000	0.000	0.000		

Click the icon () in the **TS Analysis** list to see the TS analyzing result of this channel. Click the icon () in the **Service List** to see the Services of each channel.

- TS Analysis

Click **Reset Counter** button to clear continuity count errors and restart counting. Fill in the search bar with the key words of PID / Bit rate / bandwidth / table type / service name in the search bar to get the info you want.

Channel1.1 TS Analysis Reset Counter

Search

PID	Bit Rate(Mbps)	Bandwidth(%)	Continuity Count Error	Type	Service
0x0(0)	0.001	0.085	0	PAT	
0x11(17)	0.001	0.085	0	SDT	
0x102(258)	0.001	0.085	0	Other	
0x103(259)	0.001	0.085	0	Other	
0x201(513)	0.269	22.816	0	Other	
0x202(514)	0.242	20.526	0	Other	
0x294(660)	0.021	1.781	0	Other	
0x29e(670)	0.021	1.781	0	Other	

Tips:

- Service List

Click a service name to check the detailed info of this service.

Channel : 1.1

#	Service
1	[302] CCTV 2
2	[303] CCTV 7

[302] CCTV 2

Type	PID	Bit Rate(Mbps)
PCR	8190	0.044
PMT	258	0.018
Video(MPEG2)	513	4.899
Audio	660	0.256

Close

IP Input >Settings

Here you can configure IP input parameters: **Destination IP Address**, **Destination Port**, **Protocol** (UDP/RTP), and **TS Packets Per IP Packet**. Click **Apply** to make the setting take effect.

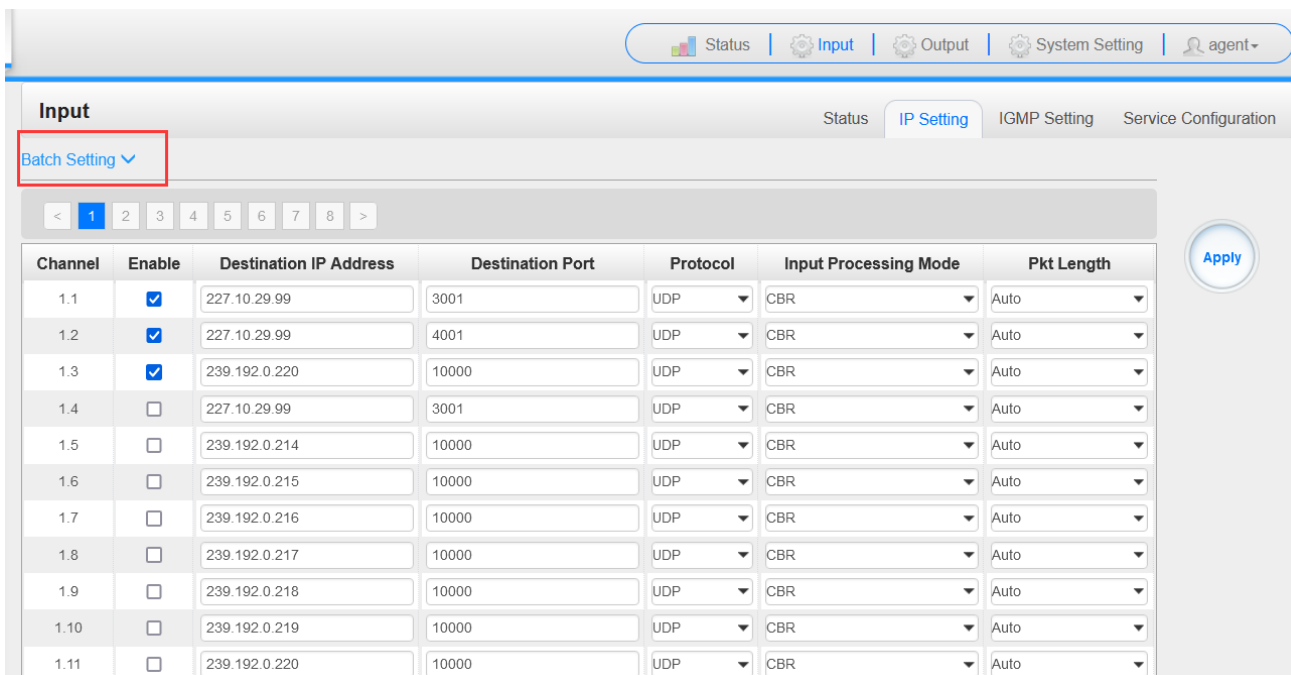

If you want to configure a batch of channels, please click “**Batch Setting**”.

To set the IP input parameters in batch, you can check the boxes before parameters you need then choose/modify the values. Click **Apply** to make the setting take effect.

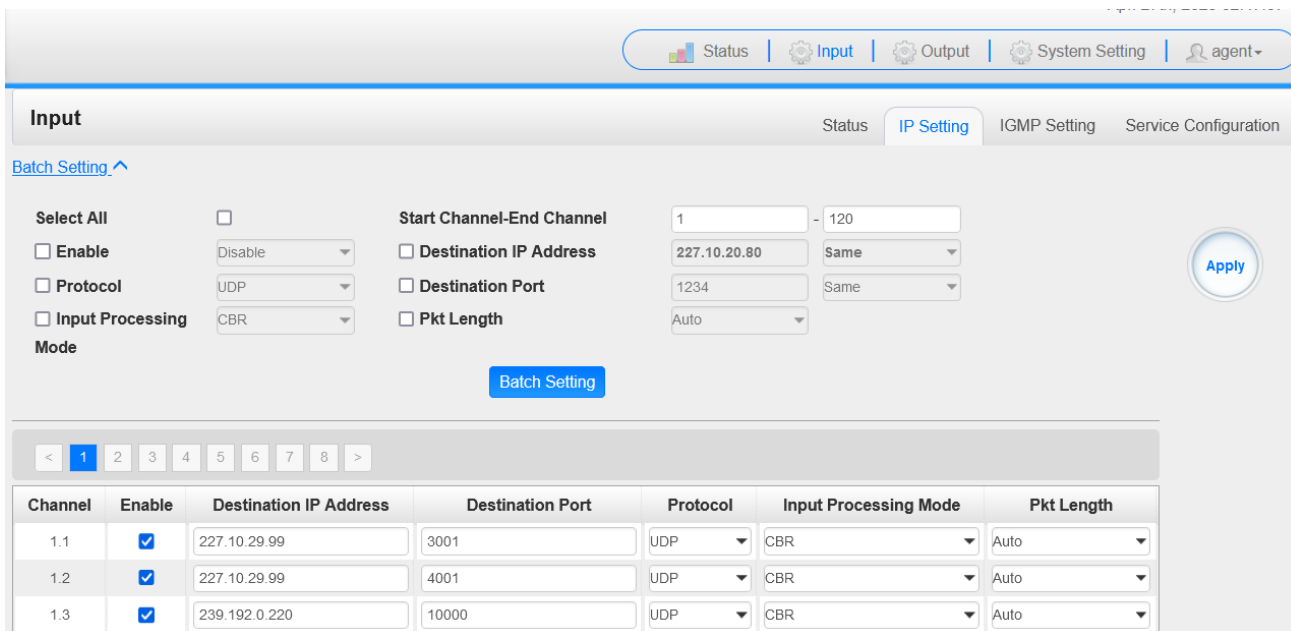

IP Input >IGMP Settings

User can set IGMP version, IGMP Automatic report, and IGMP Report Cycles in this page.

The screenshot shows the 'Input' configuration page with the 'IGMP Setting' tab selected. The settings are as follows:

- IGMP Version: V2
- IGMP Automatic Report: Enable
- IGMP Report Cycle(s): 15

An 'Apply' button is located on the right side of the configuration area.

Input >Service Configuration

To stream an input source, you can configure the destination in this page.

The screenshot shows the 'Service Configuration' page with the following parameters:

- Channel Select: Channel 1.1
- Scanning Time(ms): 1000
- PSI Search Time(ms): 5000

The table below shows the configuration for various services:

Service Name	Destination	Destination Setting
Channel 1.1 +		⚙️
[1] Program0	3.CM2-ISDBT-R01A[1.1, 1.2, 1.3, 1.4, 1.5, 1.6, 1.7, 1.8]	✍️
[2] Program1	3.CM2-ISDBT-R01A[1.1, 1.2, 1.3, 1.4, 1.5, 1.6, 1.7, 1.8]	✍️
[22] Program2	3.CM2-ISDBT-R01A[1.1, 1.2, 1.3, 1.4, 1.5, 1.6, 1.7, 1.8]	✍️
[32] Program3	3.CM2-ISDBT-R01A[1.1, 1.2, 1.3, 1.4, 1.5, 1.6, 1.7, 1.8]	✍️
[35] Program4		✍️
[33] Program5	5.CP2-ASI-00[1.1, 1.2]	✍️
PID 17 (SDT, BAT)		✍️
PID 18 (EIT)		✍️
PID 20 (TOT, TDT)		✍️
PID 21 (Other PID)		✍️
Channel 1.3 +		⚙️
[1] Program0		✍️

Buttons: 'Program Scan', 'Apply', 'Clear Config'.

- **Multiplex or Bypass stream:** Click the setting icon (⚙️), check the output module, and then you can set the output channel of this stream. After you select bypass mode, this output channel will be occupied only by this stream and when you set other stream output channels, this channel will not be available in this time.

- **Multiplex services:** You should click the service line setting icon () to make the certain service output from certain channel combining with other services. The operation you can refer to multiplex stream output.

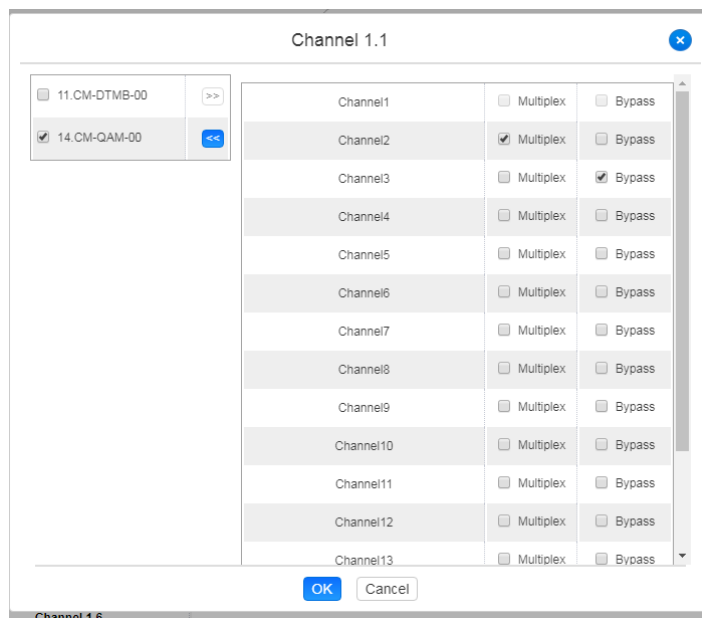

After setting output destination, click **Apply** to make it take effect. The destination channel will be displayed in the channel/service line. And you can also click **Clear Config** to clear all of the configuration.

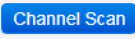

There is a channel scan button () on top. Normally the input service list of each channel will load itself on this page, but when you change the input source, the list could not refresh immediately. You can refresh the changed channels manually by selecting the channel and clicking the channel scan button.

4.5 Output

IP Output >Status

The IP output status information you can check on this page is similar as that of IP input. The TS analysis and service list function are also available.

IP Output Status Basic Setting Service Configuration PSIP

Total Bitrate : 15.000 Mbps

Chan...	IP Address : Port	Effective Bitrate...	Total Bitrate(Mbps)	Bitrate	TS Analysis	Service List
1.1	228.10.20.31 : 1234	0.045	15.000	Normal	👁	☰
1.2	227.10.20.2 : 1234	0.000	0.000	Normal	👁	☰
1.3	0.0.0.0 : 0	0.000	0.000	Normal	👁	☰
1.4	0.0.0.0 : 0	0.000	0.000	Normal	👁	☰
1.5	0.0.0.0 : 0	0.000	0.000	Normal	👁	☰
1.6	0.0.0.0 : 0	0.000	0.000	Normal	👁	☰
1.7	0.0.0.0 : 0	0.000	0.000	Normal	👁	☰
1.8	0.0.0.0 : 0	0.000	0.000	Normal	👁	☰
1.9	0.0.0.0 : 0	0.000	0.000	Normal	👁	☰
1.10	0.0.0.0 : 0	0.000	0.000	Normal	👁	☰
1.11	0.0.0.0 : 0	0.000	0.000	Normal	👁	☰
1.12	0.0.0.0 : 0	0.000	0.000	Normal	👁	☰
1.13	0.0.0.0 : 0	0.000	0.000	Normal	👁	☰
1.14	0.0.0.0 : 0	0.000	0.000	Normal	👁	☰

IP Output > IP Settings

Setting IP output channels is also similar to Setting IP input with addition of PSIP.

Status Input Output System Setting agent

Output Status IP Setting Service Configuration PSIP

Total Bitrate: 0.000 Mbps

Channel	IP Address : Port	Effective Bitrate(M...	Total Bitrate(Mbps)	Bitrate	TS Analysis	Service List
1.1	227.10.20.1 : 1234	0.000	0.000	Normal	👁	☰
1.2	227.10.20.2 : 1234	0.000	0.000	Normal	👁	☰
1.3	227.10.20.3 : 1234	0.000	0.000	Normal	👁	☰
1.4	227.10.20.4 : 1234	0.000	0.000	Normal	👁	☰
1.5	227.10.20.5 : 1234	0.000	0.000	Normal	👁	☰
1.6	227.10.20.6 : 1234	0.000	0.000	Normal	👁	☰
1.7	227.10.20.7 : 1234	0.000	0.000	Normal	👁	☰
1.8	227.10.20.8 : 1234	0.000	0.000	Normal	👁	☰
1.9	227.10.20.9 : 1234	0.000	0.000	Normal	👁	☰
1.10	227.10.20.10 : 1234	0.000	0.000	Normal	👁	☰
1.11	0.0.0.0 : 0	0.000	0.000	Normal	👁	☰
1.12	227.10.20.12 : 1234	0.000	0.000	Normal	👁	☰
1.13	0.0.0.0 : 0	0.000	0.000	Normal	👁	☰
1.14	0.0.0.0 : 0	0.000	0.000	Normal	👁	☰

- Multicast output setting: You should fill the fit multicast IP addresses as output in the **Destination IP Address** box. **Please avoid IP conflict among baseboard, encoder modules (see encoder modules page) and other devices when you set the multicast output.**

- Unicast output setting: You should fill the unicast receiving end's IP addresses in the **Destination IP Address** box.
- Destination MAC: Normally you do not need to enable the Destination MAC switch. Only in some specific case where the unicast stream cannot be received due to unknown reasons, you can enable Destination MAC and fill in the correct receiver MAC in instead of using unicast IP addresses.



Constant Rate of any output channel/TS/port ought to be set manually about 2 Mbps higher than the **Effective Bitrates** in the corresponding output channel/TS/port, since the **Effective Bitrates** might fluctuate a little bit. If you set the **Constant Rate** much higher than the **Effective Bitrates**, there will be lots of null packets in the output transport stream.

If you want to configure a batch of channels, please click “**Batch Setting**”.

Batch Setting of IP output channels is also similar to that of setting IP input.

Output
Status **IP Setting** Service Configuration PSIP

[Batch Setting](#) ^

Select All

Enable Disable

Source Port 1000

Protocol UDP

Bitrate 25 (Mbps)

Start Channel-End Channel 1 - 120

Destination IP Address 227.10.20.80 Same

Destination Port 1234 Same

Pkt Length 7

Enable Destination MAC Disable AA:BB:CC:DD:EE:FF

[Batch Setting](#)

[Apply](#)

TX Interval: 100 (ms) Null Packet Filter: Disable

< 1 2 3 4 5 6 7 8 >

Channel	Enable	Source Port	Destination IP ...	Destination...	Protocol	Pkt Length	Bitrate...	Enable Destination MAC	Destination M...
1.1	<input checked="" type="checkbox"/>	1000	227.10.20.1	1234	UDP	7	10	Disable	01:00:5E:0A:14:01
1.2	<input checked="" type="checkbox"/>	1000	227.10.20.2	1234	UDP	7	10	Disable	01:00:5E:0A:14:02
1.3	<input checked="" type="checkbox"/>	1000	227.10.20.3	1234	UDP	7	10	Disable	01:00:5E:0A:14:03
1.4	<input checked="" type="checkbox"/>	1000	227.10.20.4	1234	UDP	7	10	Disable	01:00:5E:0A:14:04

IP Output >Service Configuration

You can make configuration for output services and TS.

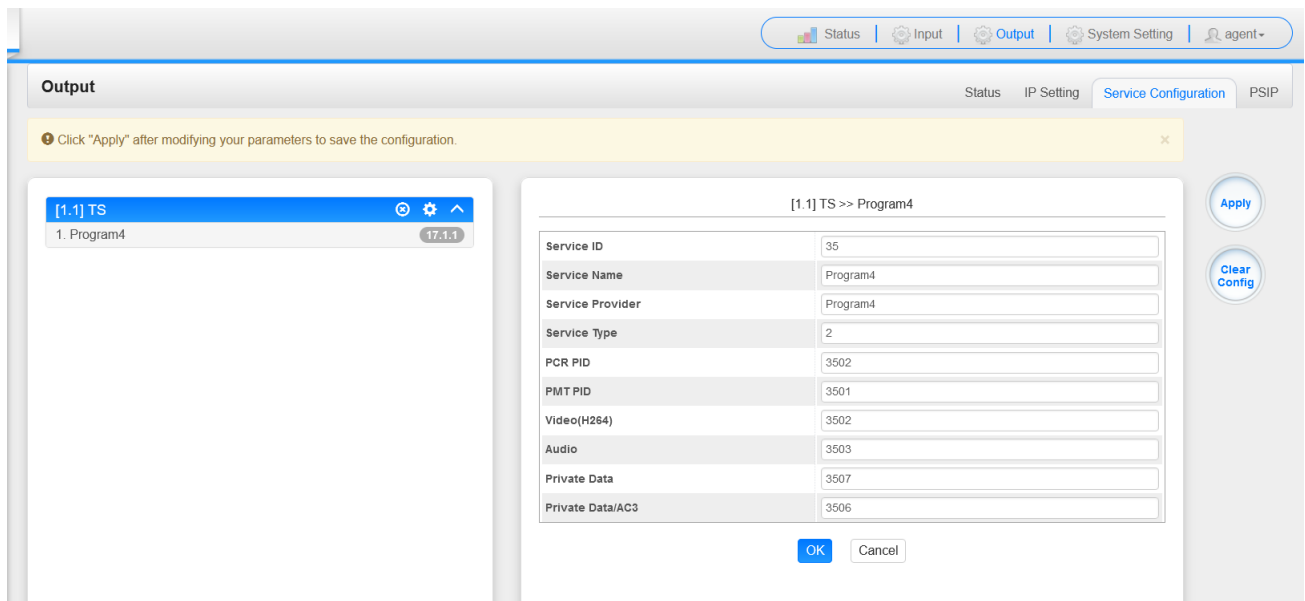

- TS setting: Click TS line (the blue area) to configure Original Network ID, TS ID and each Service ID, Service Name, and Service Provider.
- NIT setting: Please refer to CM-QAM-00 module.
- TOT setting: Configuration parameters about TOT.

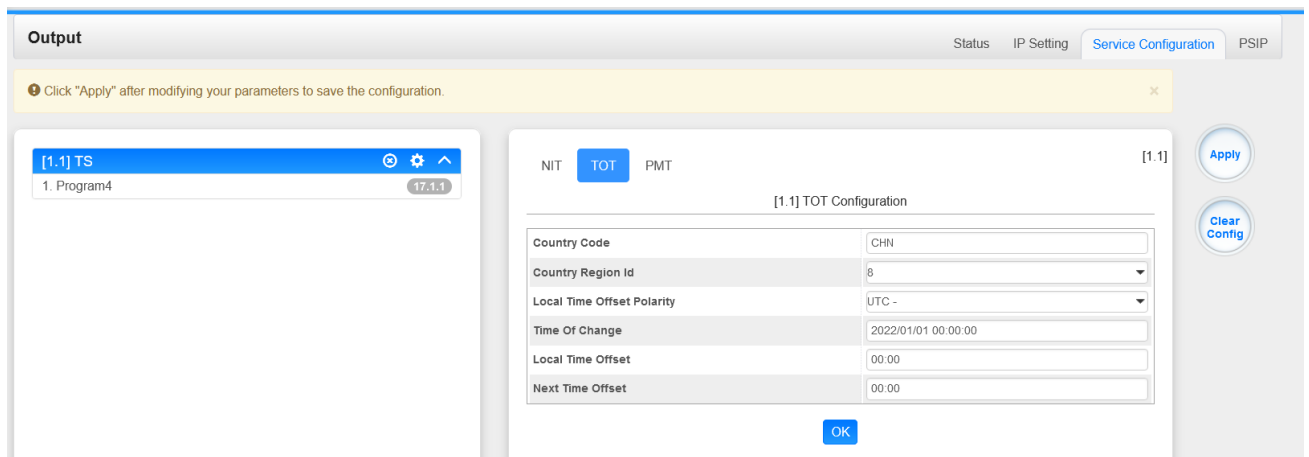

- PMT setting: Adding ES and Descriptors

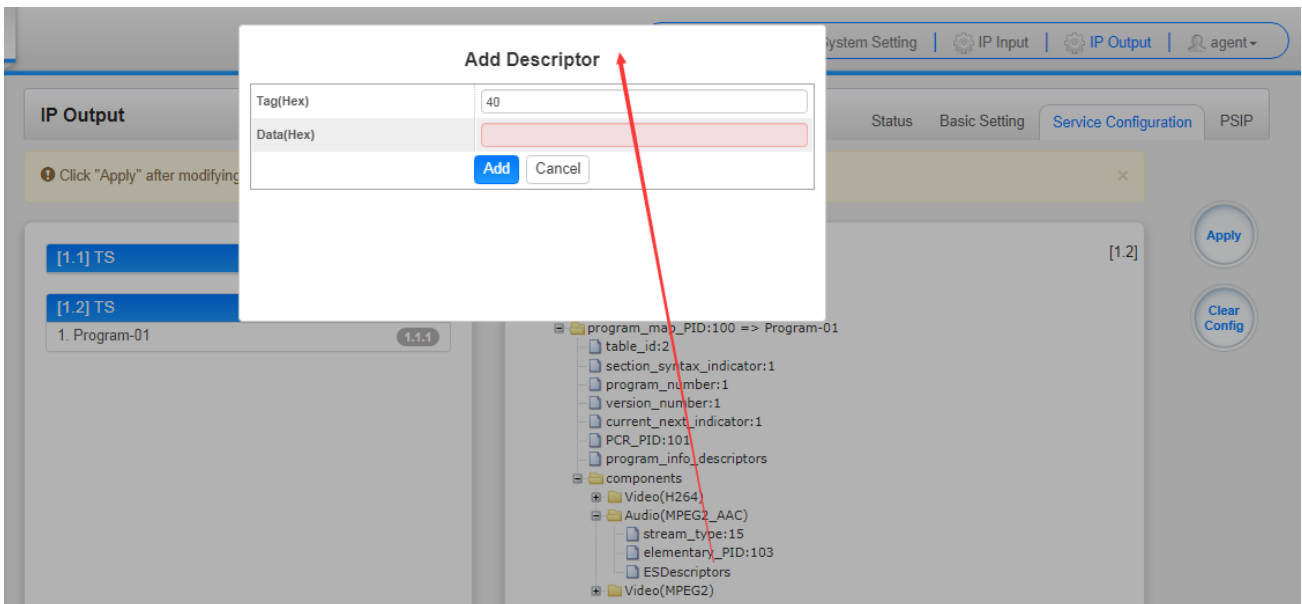
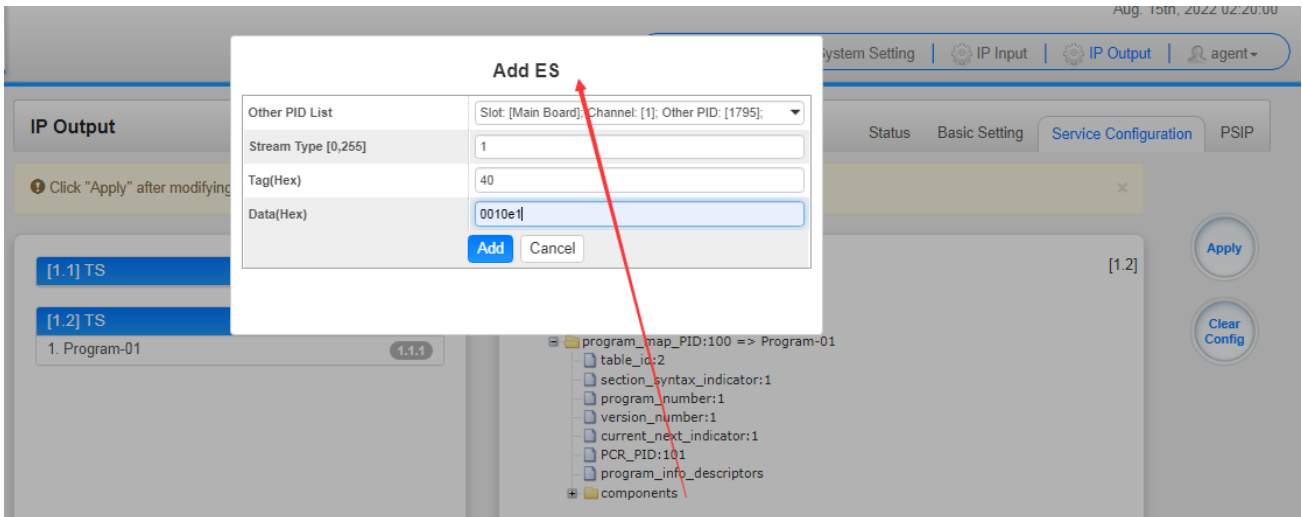

➤ **IP Output > PSIP**

PSIP page lets you out different tables such as PAT, PMT, SDT and the likes.

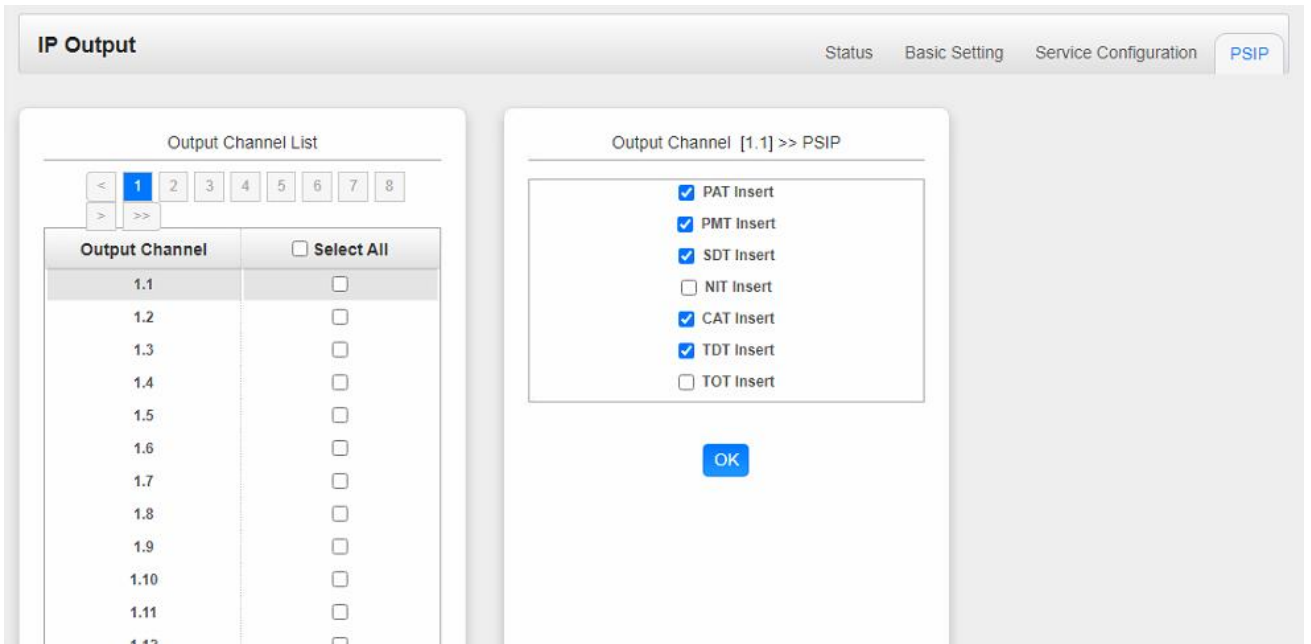

4.6 Admin

Click **Agent** and you can choose to set the password or to log out.

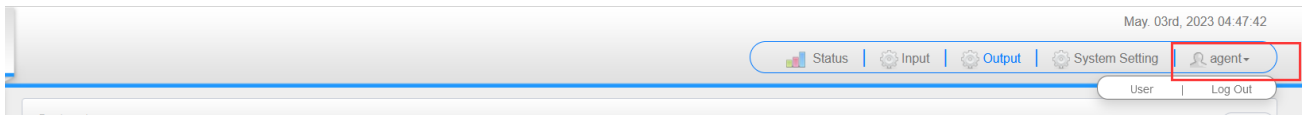

5 Module Configuration

5.1 Receiver Modules

5.1.1 CR2-DVBC-00

CR2-DVBC-00 is a 4-channel DVB- C /DTMB receiving and descrambling module with 1 RF female connector and 2 CI slots. It can receive 4 RF channels signal simultaneously and support 2 CAM cards descrambling.



Click **CR2-DVBC-00** in the Module List then go to CR2-DVBC-00 module page.

CR2-DVBC -00 >Status

CR2-DVBC-00							Status	CI	Basic Setting	Service Configuration	System
Channel	Locked Status	Total Bitrate(Mbps)	Effective Bitrate(Mbps)	PER	RF Level	TS Analysis	Service List				
1.1	Unlocked	0.000	0.000	0.000000000	-	👁	☰				
1.2	Unlocked	0.000	0.000	0.000000000	-	👁					
1.3	Unlocked	0.000	0.000	0.000000000	-	👁					
1.4	Unlocked	0.000	0.000	0.000000000	-	👁					

Click **TS Analysis** of each channel, you can see TS Bitrate Analysis. Click **Reset Counter** to reset the Continuity Count Error counter. In Search bar, you can input key words or numbers, such as PIDs, Type or Service, for a quickly search.

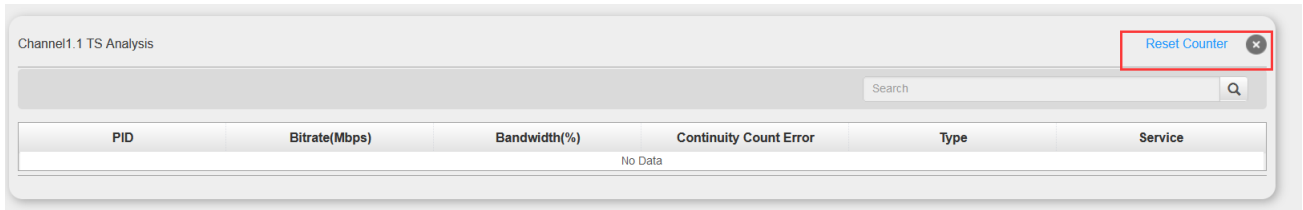

Click the icon  to check service information of all the inputs.



You can check program details by clicking the program item.

[1]

Type	PID	Bitrate(Mb...
PCR	4130(0x1022)	4.995
PMT	4128(0x1020)	0.051
StreamType:27-Video(H264)	4130(0x1022)	4.995
StreamType:4-Audio	4131(0x1023)	0.272

Close

CR2-DVBC-00 >CI

For the encrypted services received on CR2-DVBC-00 module receiver, CI slot is needed to decrypt and re-broadcast the services. The CR2-DVBC-00 has 2 CAM slots and can decrypt services depending on the capability of the CAM module and Smart Card. You can select the CAM Max Bit Rate from 48Mbps to 108Mbps in pull-down list depending on the total effective bitrate of services you want to decrypt at.

Click the **Apply** button on the right side to make the change takes effect.

CR2-DVBC -00 >Basic Setting

Channel	Frequency(KHz)	SymbolRate(KBaud)
1.1	208000	6875
1.2	208000	6875
1.3	208000	6875
1.4	208000	6875

Name	Range
Frequency (KHz)	47000~862000
Symbol Rate(KSym/s)	3600~6950



Click the **Apply** button on the right side to make the change take effect.

CR2-DVBC-00 >Service Configuration

Service Name	Descrambling	Destination	Destination Setting
Channel 1.1	+		⚙️
[1] HDMI	No Descrambling		✍️
[2] SDI	No Descrambling		✍️
PID 20 (TOT, TDT)	No Descrambling		✍️

Service Configuration page is where you can manage the received services and output them to their designated interface. The configuration of all modules in CMP201 is mostly the same.

First, you need to scan the port on each LOCKED TS. Each port might be scanned automatically or needed to be scanned manually when its source is changed.

After scanning each channel, you can start to configure the services. You need to click **Apply** button after you configure service to CAM for descrambling, otherwise the descrambling configuration will not be saved. Then you can choose the services to be routed, you can output each service by clicking the icon  and  below “Destination Settings”. You can route a whole stream or a service(s) from the input channel toward the available output channels (IP or RF). Two types of routing are possible.

1. **Bypass mode.** In this mode, you can route a whole input transport stream towards an IP or RF output which will be occupied only by this stream. Any attempt of routing other stream/service towards this channel will be an error. This mode can only be set by clicking the icon  on the TS.
2. **Multiplex mode** is the counter part of the bypass mode. This mode allows the administrator to perform the following operations:
 - a. Route a single service towards an output channel to create SPTS.
 - b. Route services towards a single output channel to create MPTS.
 - c. Route service/s AND stream/s from multiple channels towards a single output channel to create MPTS.

In **Descrambling Settings** there are CAM1, CAM2, No Descrambling to choose. Click **Apply** or **Clear Configuration** button on the right side to make the change take effect or clear all configurations.

CR2-DVBC-00 >System

The screenshot displays the 'System' configuration page for 'CR2-DVBC-00'. At the top right, there are navigation tabs: Status, CI, Basic Setting, Service Configuration, and System (selected). Below the tabs, there is a 'Change Modulate Type' dropdown set to 'DVBC' with an 'Apply' button. The 'Program Auto Scan' section has an 'Enable' checkbox and a 'Set' button. The 'License' section includes 'Product ID' (EB13144680041), 'Import License' (with 'Browse' and 'Upload' buttons), and 'Export License' (with an 'Export' button). The 'SNMP MIB' section has an 'Export MIB' button. The 'Logs' section has an 'Open' button. The 'Others' section contains 'Reboot' and 'Reset to Defaults' buttons.

On **System** page you can choose the modulation type as DVBC or DTMB Mode. Besides you can also perform **Import/Export License**, **Reboot** the module, **Restore the unit to factory defaults** and **Log Export & Clear**.

5.1.2 CR2-DVBC-01

4-channel DVB-C Annex A/C or ISDBT receiver descrambling board (one signal input interface, support signal internal loop connection, two CAM slots)

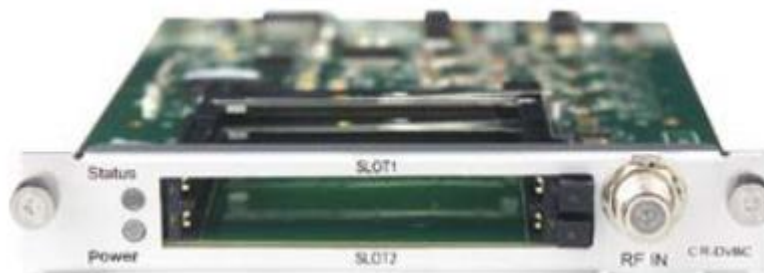

The configuration and parameters are almost the same as DVBC-00.

5.1.3 CR2-DVBS2CI-01

CR2-DVBS2CI-01 is a 4-channel DVB-S/S2 receiving descrambling board (two DVB-S2 signal input interfaces, two CAM slots).



Service configuration is similar to CR2-DVBC-00. **Status**, **CI Status** and **System** operation refer to CR2-DVBC -00 module section.

CR2-DVBS2CI-01 >Basic Setting

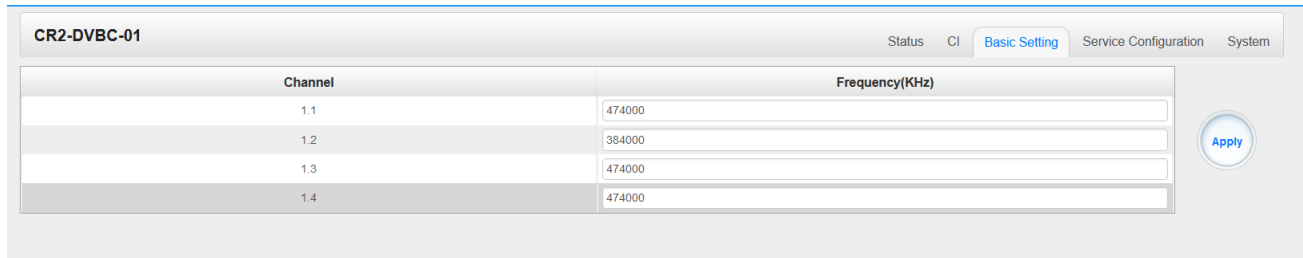

Name	Range
Frequency (KHz)	47000~862000
Symbol Rate(KSym/s)	3600~6950

5.1.4 CR2-DVBS2FTA-01/01A

CR2-DVBS2FTA-01 is a 4-channel DVB-S/S2/S2XFTA receiving module with 4 RF connectors, and 4 LNBs that are independently powered. S2 supports up to 32APSK, S2X supports up to 64APSK.



CR2-DVBS2FTA-01 > Status

1: CR2-DVBS2FTA-01											
Channel	Locked Status	Total Bitrate(Mbps)	Effective Bitrate(Mbps)	PER	RF Level	CNR(dB)	Link Margin(...)	FEC Code Rate	Modulation	TS Analy...	Service I
1.1	Locked	130.159	7.500	0.000000000	-34dBm (74dBuV)	24.000	5	11/15	64APSK		
2.1	Unlocked	0.000	0.000	0.000000000	-	0.000	0	1/2			
3.1	Unlocked	0.000	0.000	0.000000000	-	0.000	0	1/2			
4.1	Unlocked	0.000	0.000	0.000000000	-	0.000	0	1/2			

Click **TS Analysis** of each channel, you can see TS bit rate analysis. Click **Reset Counter** to reset the Continuity Count Error counter. In Search bar, you can input key words or numbers, such as PIDs, Type or service, for a quickly search.

Channel 1.1 TS Analysis

[Reset Counter](#)

Search

PID	Bitrate(Mbps)	Bandwidth(%)	Continuity Count Error	Type	Service
0x0(0)	0.007	0.025	0	PAT	
0x1e0(480)	0.007	0.025	0	PMT	
0x1001(4097)	7.213	26.091	0	PCR, Video	
0x1002(4098)	0.270	0.977	0	Audio	

Tips:

Click the icon to check service information of all the inputs.

Channel : 1.1		Channel : 2.1		Channel : 3.1		Channel : 4.1	
#	Service	#	Service	#	Service	#	Service
1	[100]	1	[302] CCTV 2	1	[302] CCTV 2	1	[302] CCTV 2
		2	[307] CCTV 15	2	[307] CCTV 15	2	[307] CCTV 15
		3	[402] HNSTVHD	3	[402] HNSTVHD	3	[402] HNSTVHD
		4	[412] HNTVAVS+	4	[412] HNTVAVS+	4	[412] HNTVAVS+
		5	[2] Encryption	5	[2] Encryption	5	[2] Encryption
		6	[500] JIajjakatong	6	[500] JIajjakatong	6	[500] JIajjakatong

You can check program details by clicking the program item.

CR2-DVS2FTA-01 > Parameter Setting

Channel	Satellite Frequency(MHz)	SymbolRate(KBaud)	LNB Frequency(MHz)	LNB Power	LNB 22KHz	DiSEqC Level	DiSEqC Port	DiSEqC Bytes(Hex)
1.1	3840	27500	5150	off	off	Disable	1	FFFFFFFFFFFF
2.1	3840	27500	5150	off	off	Disable	1	FFFFFFFFFFFF
3.1	3840	27500	5150	off	off	Disable	1	FFFFFFFFFFFF
4.1	3840	27500	5150	off	off	Disable	1	FFFFFFFFFFFF
5.1	3840	27500	5150	off	off	Disable	1	FFFFFFFFFFFF
6.1	3840	27500	5150	off	off	Disable	1	FFFFFFFFFFFF
7.1	3840	27500	5150	off	off	Disable	1	FFFFFFFFFFFF
8.1	3840	27500	5150	off	off	Disable	1	FFFFFFFFFFFF

Channel 1.1, 1.2, 1.3 and 1.4, 4 LNBs are powered independently.

Name	Range
Satellite Frequency (MHz)	950~14500
Symbol Rate(KBaud)	1000~45000
LNB Frequency(MHz)	0~13550
LNB Power	Off/13v/18v
LNB 22KHz	Off/22KHz
DiSEqC Level	1.0, 1.1, 1.1+1.0, Manually Defined, Disable
DiSEqC Port	1,2,3,4
DiSEqC Bytes	In HEX

The absolute value of the difference between the Satellite Frequency and the LNB Frequency must be in the range [950, 2150].

Click the **Apply** button on the right side to make the changes made take effect.

CR2-DVS2FTA-01 > Biss

Here you can create **Biss ID**, including **Mode**, **Key** and **Injected ID**. And you can check the Service Information in the **Service List**, then select **Biss ID/Biss-Off** for the services.

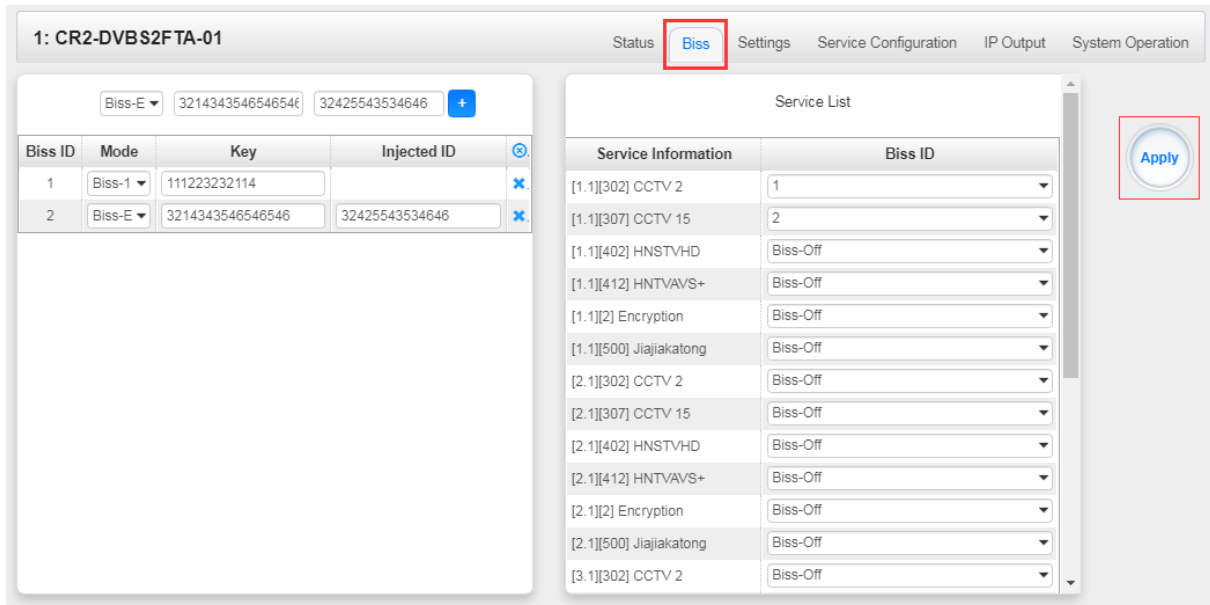

Click the **Apply** button on the right side to make the changes made take effect.

CR2-DVS2FTA-01 > Service Configuration

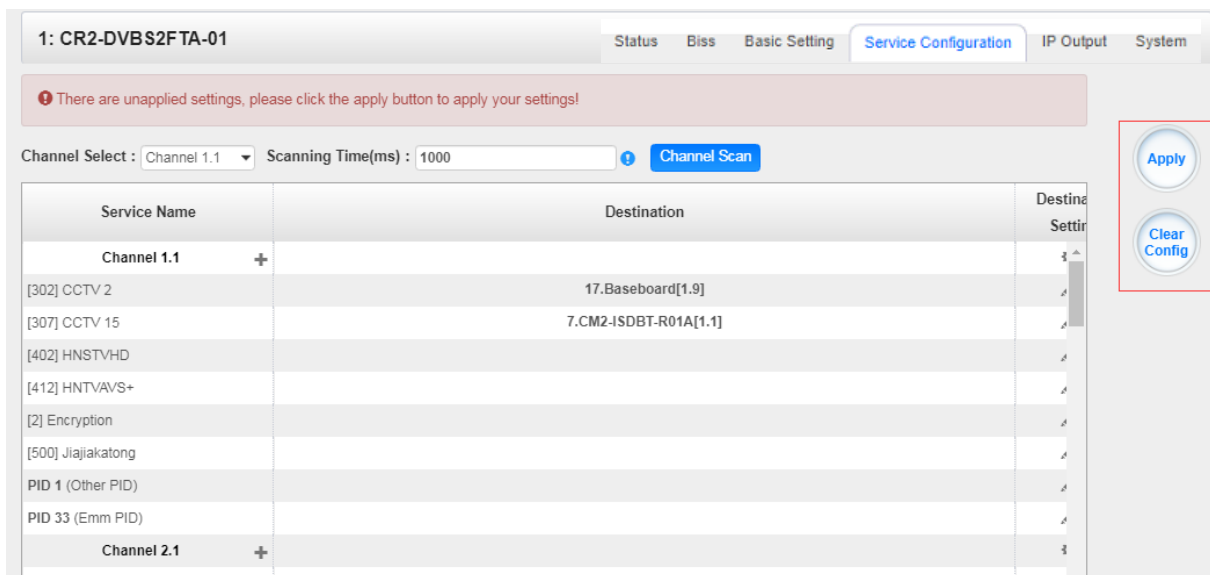

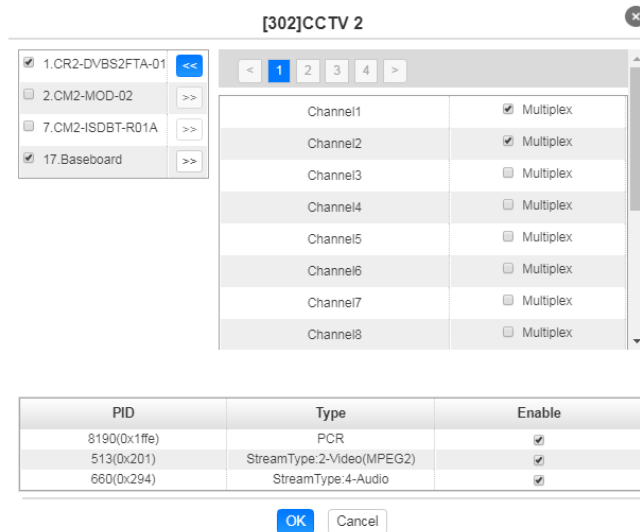

Click **Apply** or **Clear Configuration** button on the right side to make the changes made take effect or clear all configuration.

- **Scanning Time (ms)**1000~12000. Please try to increase this value if service name is not present, while it will slow down scanning process.

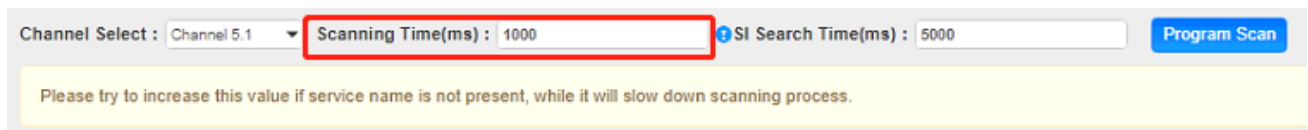

- **SI Search Time (ms)**5000~12000. Please try to increase this value if SI is not present, while it will slow down scanning process.

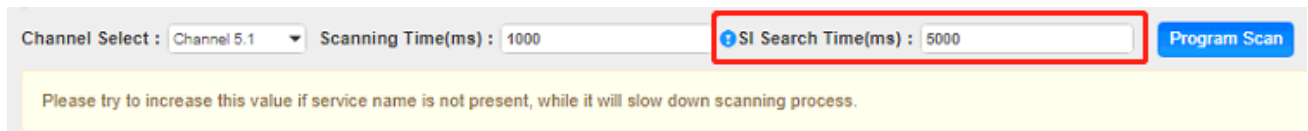

CR2-DVS2FTA-01 > IP Output

This feature enables you to output S2 services directly without involving baseboard processing. No baseboard resources will be consumed in this way.

IP Output > Status> This page shows detailed status of each channel. The TS Analysis and Service List here have the same function to those on the Status page. See the image below for reference.

1: CR2-DVBS2FTA-01

Status Biss Settings Service Configuration **IP Output** System Operation

Status Settings Service Configuration

Channel	Total Bitrate(Mbps)	Effective Bitrate(Mbps)	Bitrate	IP Address : Port	TS Analysis	Service List
1.1	25.004	0.042	Normal	227.10.30.1 : 1234	<input checked="" type="checkbox"/>	
1.2	25.004	0.042	Normal	227.10.30.2 : 1234	<input type="checkbox"/>	
1.3	0.000	0.000	Normal	227.10.30.3 : 1234	<input type="checkbox"/>	
1.4	0.000	0.000	Normal	227.10.30.4 : 1234	<input type="checkbox"/>	
1.5	0.000	0.000	Normal	227.10.30.5 : 1234	<input type="checkbox"/>	
1.6	0.000	0.000	Normal	0.0.0.0 : 0	<input type="checkbox"/>	
1.7	0.000	0.000	Normal	0.0.0.0 : 0	<input type="checkbox"/>	
1.8	0.000	0.000	Normal	0.0.0.0 : 0	<input type="checkbox"/>	
1.9	0.000	0.000	Normal	0.0.0.0 : 0	<input type="checkbox"/>	
1.10	0.000	0.000	Normal	0.0.0.0 : 0	<input type="checkbox"/>	
1.11	0.000	0.000	Normal	0.0.0.0 : 0	<input type="checkbox"/>	
1.12	0.000	0.000	Normal	0.0.0.0 : 0	<input type="checkbox"/>	
1.13	0.000	0.000	Normal	0.0.0.0 : 0	<input type="checkbox"/>	

Channel : 1.1

#	Service
1	[302] CCTV 2

Channel 1.1 TS Analysis Reset Counter

Search

PID	Bitrate(Mbps)	Bandwidth(%)	Continuity Count Error	Type	Service
0x0(0)	0.015	0.060	0	PAT	
0x11(17)	0.013	0.052	0	SDT	
0x102(258)	0.013	0.052	0	PMT	CCTV 2
0x201(513)	0.000	0.000	0	Video	CCTV 2

1: CR2-DVBS2FTA-01

Status Biss Settings Service Configuration **IP Output** System Operation

Status Settings Service Configuration

Channel	Total Bitrate(Mbps)	Effective Bitrate(Mb...	Bitrate	IP Address : Port	TS Analysis	Service List
1.52	0.000	0.000	Normal	0.0.0.0 : 0	<input type="checkbox"/>	
1.53	0.000	0.000	Normal	0.0.0.0 : 0	<input type="checkbox"/>	
1.54	0.000	0.000	Normal	0.0.0.0 : 0	<input type="checkbox"/>	
1.55	0.000	0.000	Normal	0.0.0.0 : 0	<input type="checkbox"/>	
1.56	0.000	0.000	Normal	0.0.0.0 : 0	<input type="checkbox"/>	
1.57	0.000	0.000	Normal	0.0.0.0 : 0	<input type="checkbox"/>	
1.58	0.000	0.000	Normal	0.0.0.0 : 0	<input type="checkbox"/>	
1.59	0.000	0.000	Normal	0.0.0.0 : 0	<input type="checkbox"/>	
1.60	0.000	0.000	Normal	0.0.0.0 : 0	<input type="checkbox"/>	
1.61	0.000	0.000	Normal	0.0.0.0 : 0	<input type="checkbox"/>	
1.62	0.000	0.000	Normal	0.0.0.0 : 0	<input type="checkbox"/>	
1.63	0.000	0.000	Normal	0.0.0.0 : 0	<input type="checkbox"/>	
1.64	0.000	0.000	Normal	0.0.0.0 : 0	<input type="checkbox"/>	

IP Output > Settings >On this page, there are three tabs where you can modify the multicast IP, ports and parameters of IP Output. There is also Batch Setting. The destination IP address can be multicast IP address or unicast IP address.

There are 64 IP output channels. Mark the Enable checkbox in front of each channel. Input the correct Multicast/Unicast IP address, port and appropriate output bitrate, and select a correct output protocol. Click **Apply** to make the changes take effect.

Batch Setting is where you can input the IP output parameters in batch. See the image below for reference.

Batch Setting

Select All Enable Source Port Protocol Bitrate

Start Channel-End Channel: 1 - 64

Destination IP Address: 227.10.20.80

Destination Port: 1234

TS Packets Per IP Packet: 7

Enable Destination MAC: AA:BB:CC:DD:EE

TX Interval: 100

Channel	Enable	Source Port	Destination IP Address	Destination P...	Protocol	TS Packets Per IP Pa...	Bitrate(Mbps)	Enable Destination M...	Destin
1.1	<input checked="" type="checkbox"/>	1000	227.10.30.1	1234	UDP	7	25	Disable	01:00
1.2	<input checked="" type="checkbox"/>	1000	227.10.30.2	1234	UDP	7	25	Disable	01:00
1.3	<input checked="" type="checkbox"/>	1000	227.10.30.3	1234	UDP	7	25	Disable	01:00
1.4	<input checked="" type="checkbox"/>	1000	227.10.30.4	1234	UDP	7	25	Disable	01:00
1.5	<input checked="" type="checkbox"/>	1000	227.10.30.5	1234	UDP	7	25	Disable	01:00
1.6	<input type="checkbox"/>	1000	227.10.30.6	1234	UDP	7	25	Disable	00:00
1.7	<input type="checkbox"/>	1000	227.10.30.7	1234	UDP	7	25	Disable	00:00
1.8	<input type="checkbox"/>	1000	227.10.30.8	1234	UDP	7	25	Disable	00:00



If you want to use IP output channels in the receiver module and baseboard IP output channel at the same time, you should avoid multicast IP addresses conflicts. If there are two identical IP addresses enabled concurrently, both the multicast transport streams will be affected.

IP Output > Service Configuration Users can make configuration for output services.

- TS setting: Click TS line (the blue area) to make the modification of Original Network ID, TS ID and each Service ID, Service Name, and Service Provider, etc.

Please click "Apply" after modifying parameters. Otherwise, new configuration can not be saved.

[1.1] TS

Original Network ID: 1

TS ID: 1

NO.	Service ID	Service Name	Service Provider
1	302	CCTV 2	CCTV

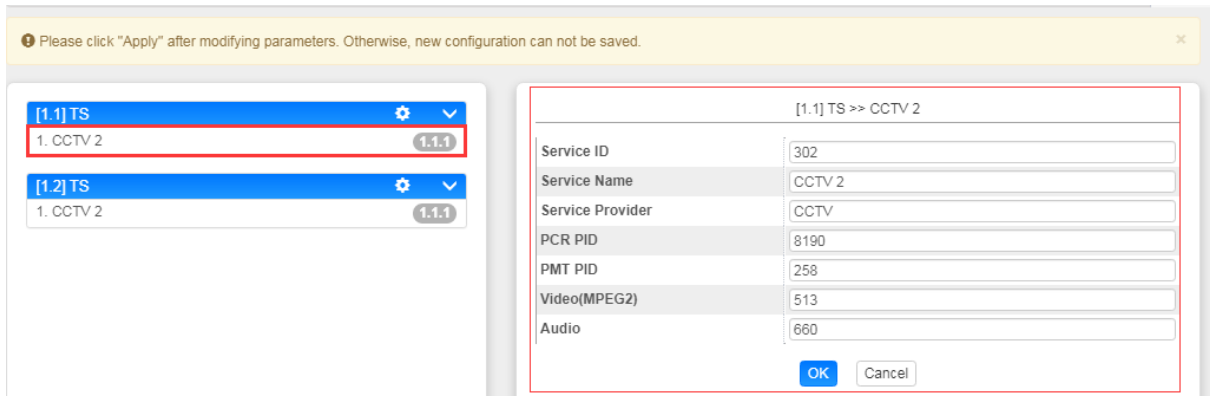

- TS setting: Click TS line (the blue area) to configure Original Network ID, TS ID and each Service ID, Service Name, and Service Provider, etc.
- NIT setting: Click the icon  to modify NIT Network and NIT Stream.

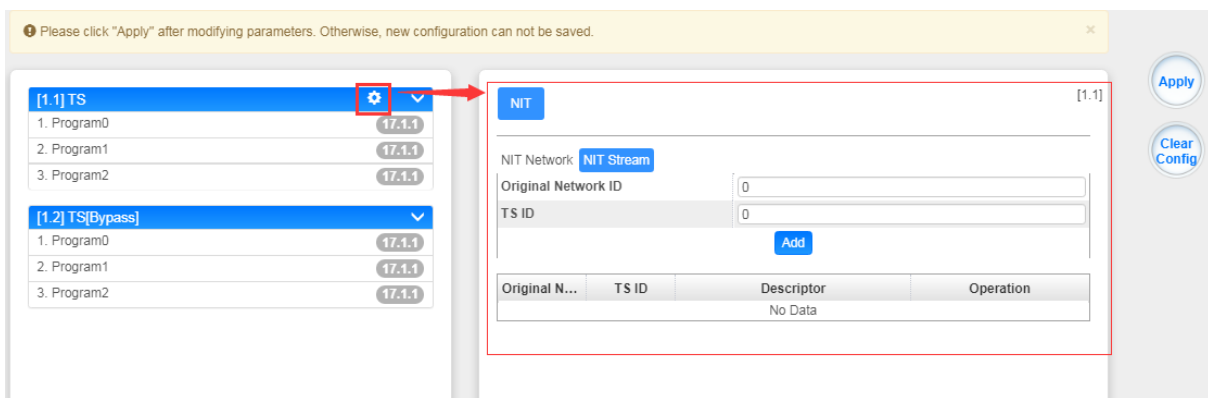

CR2-DVS2FTA-01 > System



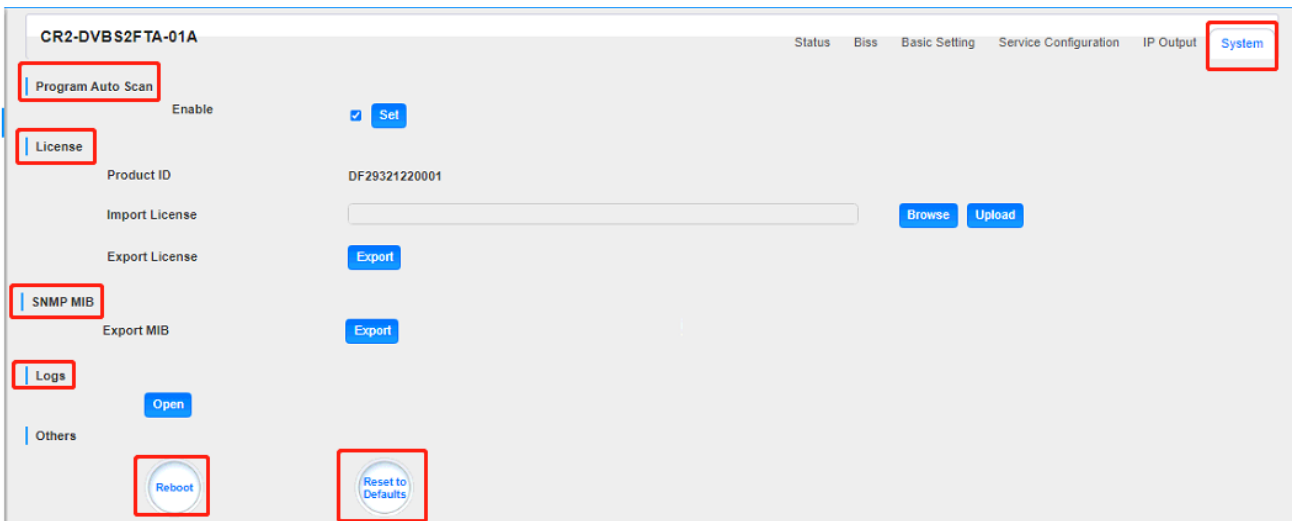

On **System** page you can Enable/Disable Program Auto Scan, import/export **License**, export SNMP MIB files, **Reboot** module, restore **factory default settings** and manage **logs**.

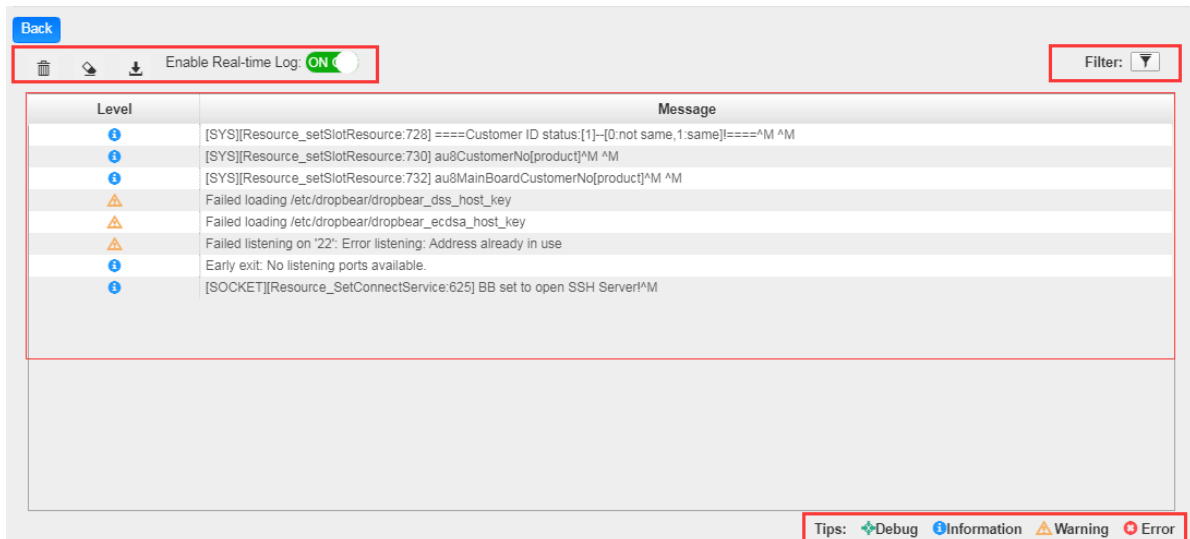

Log Manage>This page shows the logs of the module. If there are issues encountered on this module, exporting the logs will help R&D team to analyze and fix them.

Turn on **Enable Real-time Log** switch, see the real time log messages and the security level of each message below.



- Click  to clear all log messages on the screen.
- Click  to delete all log information.
- Click  to export log information.
- Click  to filter desired log messages.

Clicking the filter icon, you can simply select what logs to be included.

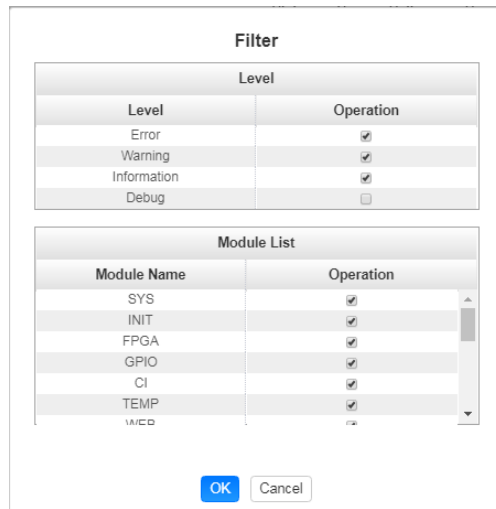

5.1.5 CR2-8VSB-00

CR2-8VSB-00 is a 4-channel 8VSB receiving module with 4 RF connectors. 8VSB receiver is mainly adopted on ATSC standard.

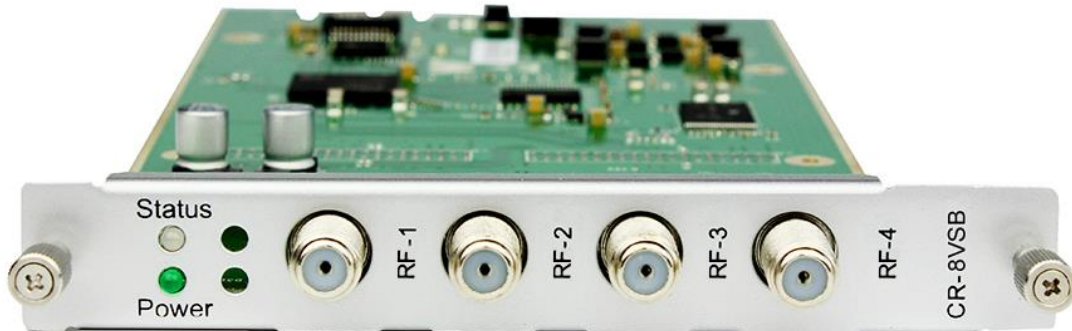

CR2-8VSB-00 >Status

CR2-8VSB-00						
Status Basic Setting Service Configuration System						
Channel	Locked Status	Total Bitrate(Mbps)	Effective Bitrate(Mbps)	RF Level	TS Analysis	Service List
1.1	Unlocked	0.000	0.000	-	👁	☰
2.1	Unlocked	0.000	0.000	-	👁	
3.1	Unlocked	0.000	0.000	-	👁	
4.1	Unlocked	0.000	0.000	-	👁	

CR2-8VSB-00>Basic Setting

4 -channels receiving is supported with 4 connectors. All the CHs at specific frequency points are displayed when you select the fixed Channel Standard.

Don't forget to click **Apply** to finish configuration.

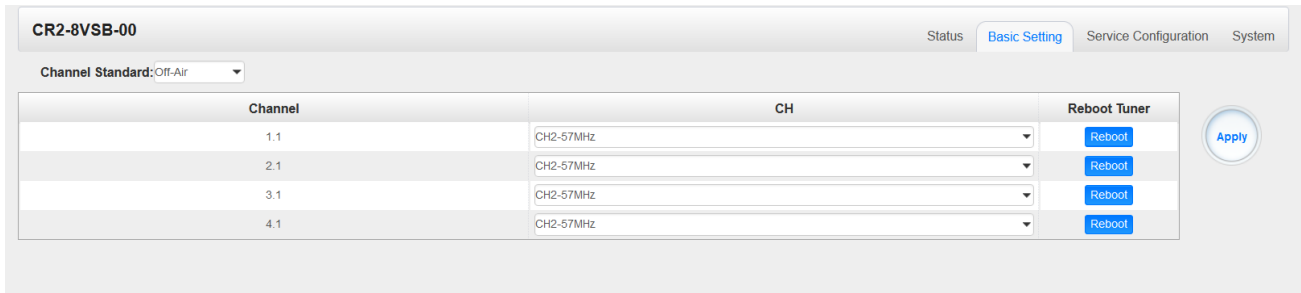

Channel standard	CH
Off-Air	CH2-57MHz, CH3-63MHz, CH4-69MHz~ CH67-791MHz, CH68-797MHz, CH69-803MHz
STD	CH2-57MHz, CH3-63MHz, CH4-69MHz~ CH133-849MHz,CH134-855MHz, CH135-861MHz
IRC	CH2-57MHz, CH3-63MHz, CH4-69MHz~ CH133-849MHz,CH134-855MHz, CH135-861MHz
HRC	CH2-55.75MHz, CH3-61.75MHz, CH4-67.75MHz~ CH133-847.75MHz,CH134-853.75MHz, CH135-859.75MHz

Status, **Service Configuration** and **System** is similar to CR2-DVBC-00.

5.1.6 CR2-DVBT2CI-00

CR2-DVBT2CI-00 is a 4-channel DVB-T/T2 receiving and descrambling module with 1 RF connectors and 2 CI slots.



Module configuration is similar to CR2-DVBC-00.

CR2-DVBT2CI-00 >Basic Setting

CR2-DVBT2CI-00 Status **Basic Setting** Service Configuration System

T2 MI:

Channel	Frequency(KHz)	Bandwidth(MHz)	PLP ID	Reboot Tuner
1.1	<input type="text" value="474000"/>	8	0	<input type="button" value="Reboot"/>
1.2	<input type="text" value="474000"/>	8	0	<input type="button" value="Reboot"/>
1.3	<input type="text" value="474000"/>	8	0	<input type="button" value="Reboot"/>
1.4	<input type="text" value="474000"/>	8	0	<input type="button" value="Reboot"/>

Name	Range
Frequency (KHz)	47000~862000
Bandwidth (Mbps)	6 / 7 / 8 M

Click the **Apply** button on the right side to make the change take effect.

Status, CI, Service Configuration and **System** please refer to CR2-DVBC-00.

5.2 Encoder Modules

5.2.1 CE2-HDMI-00/R01

CE2-HDMI-00 is a 4-channel HDMI input encoder which supports H.264 HD/SD or MPEG-2 SD encoding. The module supports MPEG1-L2, AAC and AC3 audio encoding.



CE2-HDMI-00/R01 >Status

CE2-HDMI-R01 Status Basic Setting Insertion Output System

HDCP turned on.

Program	Signal	HDCP Encryption	Input Video Resolution	Output Video Resolution	Total Bitrate(Mbps)	Effective Bitrate(Mbps)	TS Analysis	Program Name
1	✘	Unencrypted	No_Video	No_Video	0.000	0.000	👁	Program-01 ⓘ
2	✘	Unencrypted	No_Video	No_Video	0.000	0.000	👁	Program-02 ⓘ
3	✘	Unencrypted	No_Video	No_Video	0.000	0.000	👁	Program-03 ⓘ
4	✘	Unencrypted	No_Video	No_Video	0.000	0.000	👁	Program-04 ⓘ

CE2-HDMI-00/R01 >Basic Setting

CE2-HDMI-R01 Status **Basic Setting** Insertion Output System

⚙️ Advanced Setting >

Program	Video Encoding Format	Video Resolution	Video Bitrate(Kbps)	GOP Size	Profile	Video Aspect Ratio	Audio Encoding Format	Audio Bitrate(Kbps)	Volume
1	H.264	Auto	8000	25	Main	Automatic	MPEG1_Layer2	128	0
2	H.264	Auto	8000	25	Main	Automatic	MPEG1_Layer2	128	0
3	H.264	Auto	8000	25	Main	Automatic	MPEG1_Layer2	128	0
4	H.264	Auto	8000	25	Main	Automatic	MPEG1_Layer2	128	0

Apply

HDCP Test Mode: ON ⓘ HDCP test mode is for test purposes only. Please make sure you have the right to use the content!

Click **Advanced Setting** to see all parameters you can modify and check what specific parameters you want to set and see. Click the **Apply** button on the right side to make the change take effect.

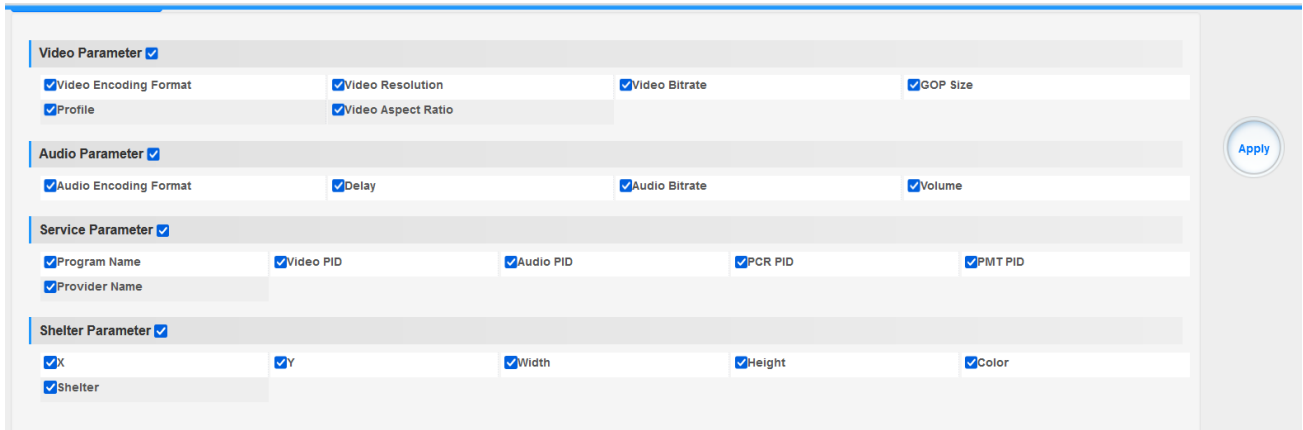

Setting range:

Video Encode Settings	Range	Video Encode Settings	Range
Video Type	H264 , MPEG2	GOP Close	Disable, Enable
Video Bitrate (Kbps)	600~20000	PCR2 PID	32~8190
Video Mode	CBR, VBR	PMT PID	32~8190
Video Max Bitrate (Kbps)	20000	Service Name	Length is 1~16
Video Min Bitrate (Kbps)	0	Service Provider Name	Length is 1~16
Video Resolution	Auto , 1920×1080_60i , 1920×1080_50i , 1920×1080_30p , 1920×1080_25p , 1080×720_60p, 1080×720_50p, 720×480_60i , 720×576_50i	VLC Mode	CABAC CAVLC
Video Frame Bitrate	Auto 59.94/29.97	Profile	HIGH MAIN
Video PID	32~8190	Level	3.0,3.1,3.2 4.0,4.1,4.2

GOP Structure	IPPB, IPPP, IBP	Video Aspect Ratio	Auto 16x9_LetterBox 16x9_CutOff 4x3_PillarBox 4x3_CutOff
GOP Size	6~63		

Audio Encode Settings	Range	Audio Encode Settings	Range
Encoding Type	AC3 MPEG1_Layer2 MPEG2_AAC MPEG4_AAC	Audio Sampling Bitrate (KHz)	48
Audio Mode	Dual Channel Mono Stereo	Audio PID	32~8190
Encoding Bitrate(Kbps)	128~384 (AC3) 64~384(MPEG1_Layer2) 32~384(MPEG2_AAC/ MPEG4_AAC)	Volume	0~8

CE2-HDMI-R01 >Basic Setting

CE2-HDMI-00 is similar to CE2-HDMI-R01, there are a few differences on Advanced Setting range.

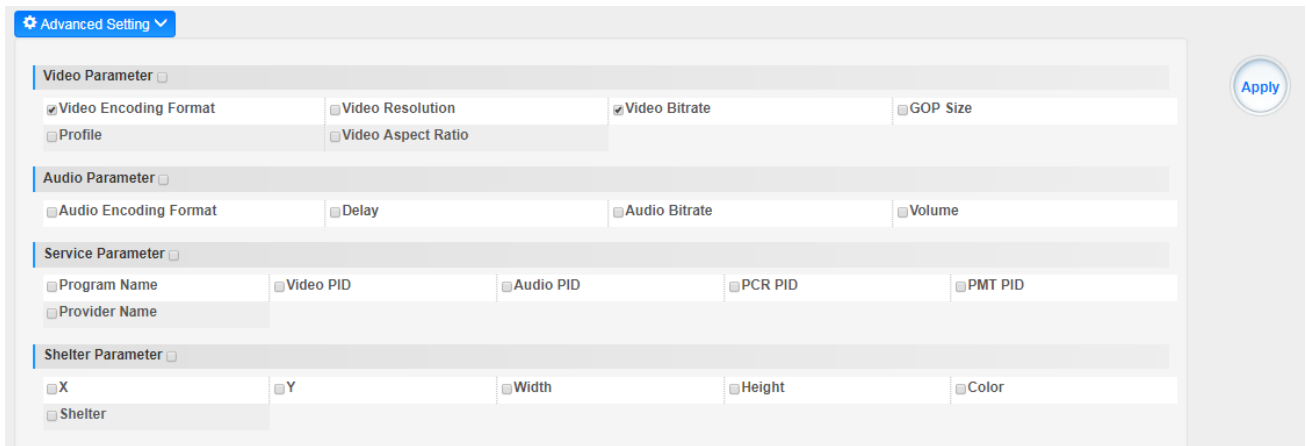

Video Encode Settings	Range	Video Encode Settings	Range
Video Type	H264	PCR2 PID	32~8190
GOP Size	1~99	PMT PID	32~8190
Video Resolution	Auto , 1920x1080_60i , 1920x1080_50i , 1920x1080_30p , 1920x1080_25p , 1080x720_60p 1080x720_50p , 720x480_60i , 720x576_50i	Program Name	Length is 1~16
Profile	HIGH MAIN	Provider Name	Length is 1~16
Video PID	32~8190		

Audio Encode Settings	Range	Audio Encode Settings	Range
Audio Type	MPEG1_Layer2 AC3 AAC	Audio PID	32~8190
Audio Bit rate(Kbps)	32~192	Volume(dB)	-20~20
Delays(ms)	-2000~2000		

Shelter Parameters	Range	Shelter Parameters	Range
Shelter	Enable/Disable	X	0~1920 (Dual)
Y	0~1080 (Dual)	Width	2~1920 (Dual)
Height	2~1080 (Dual)	Color	White/Black/Blue/Green/Red

CE2-HDMI-00/R01 >Output

CE2-HDMI-00 Status Basic Setting **Output** System

Direct IP Output Multiplexing

Program	Enable	Destination IP Address	Destination Port	Enable Destination MAC	Destination MAC
1	<input checked="" type="checkbox"/>	227.10.20.90	1234	Disable	01:00:5E:0A:14:5A
2	<input type="checkbox"/>	227.10.20.90	1235	Disable	00:00:00:00:00:00
3	<input type="checkbox"/>	227.10.20.90	1236	Disable	00:00:00:00:00:00
4	<input type="checkbox"/>	227.10.20.90	1237	Disable	00:00:00:00:00:00

Advanced Setting

[Apply](#)

CE2-HDMI-R01 Status Basic Setting Insertion **Output** System

Direct IP Output Multiplexing RTMP Output

Program	Enable	Destination IP Address	Destination Port	Enable Destination MAC	Destination MAC
1	<input checked="" type="checkbox"/>	227.10.20.90	1234	Disable	01:00:5E:0A:14:5A
2	<input checked="" type="checkbox"/>	227.10.20.90	1235	Disable	01:00:5E:0A:14:5A
3	<input checked="" type="checkbox"/>	227.10.20.90	1236	Disable	01:00:5E:0A:14:5A
4	<input checked="" type="checkbox"/>	227.10.20.90	1237	Disable	01:00:5E:0A:14:5A

[Apply](#)

For the Output, both models have direct IP output and multiplexing, but only CE2-HDMI-R01 has RTMP output settings.

This feature is specifically for single program encoding and IP output directly. Outputting in this way will not occupied baseboard multicast bandwidth.



If you want to use IP output channel in the encoder module and the baseboard IP module at the same time, you should avoid a multicast IP address conflict. If there are two same IP addresses enabled meantime, all the multicast videos will be affected.

- **Destination IP Address** and **Destination Port**: Using for multicast IP addresses or unicast IP addresses and ports.
- **Enable Destination MAC**: Generally, you do not need to enable this option. This is reserved for exceptional cases where the unicast stream cannot be received with unicast IP addresses. You can enable destination MAC and streaming out by setting Destination MAC.
- **Advance Setting (only available in CE2-HDMI-00)**:

Advance Settings

Enable the second eth:

IP Address	Subnet Mask	Default Gateway	MAC Address
192.168.131.45	255.255.255.0	192.168.131.254	A0:69:86:02:39:CE

The second eth is reserved for you to output IP streams in another different VLAN. You can output unicast streams to the another VLAN by enabling the second eth and setting **IP Address**, **Subnet Mask**, **Default Gateway** in the same segment of the unicast IP (the another different VLAN).

CE2-HDMI-R01 Status Basic Setting Insertion **Output** System

Direct IP Output **Multiplexing** RTMP Output

Program	Program Name	Destination	Destination Setting
1	Program-01		✎
2	Program-02		✎
3	Program-03		✎
4	Program-04		✎

To use **Multiplexing mode on service level**

1. Click on the pencil icon ✎ . There will always be a Base Board selection for the IP output and other Output options depending on the modules inserted.
2. Select the correct Output and Channel you want to output the Service to.
3. Check Multiplex for the Channel you want to output through. You can output multiple services in the same channel or output the same service in multiple channels.

To use RTMP output to configure streaming to any website capable of receiving RTMP, it is necessary to create a new stream instance on the intended receiving platform and enter the corresponding URL and port.

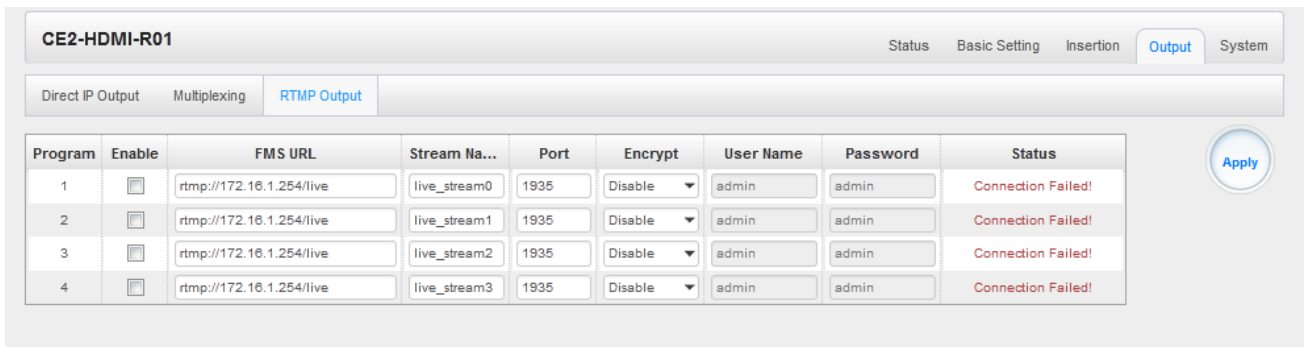

CE2-HDMI-R01 >Insertion (only available in the CE2-HDMI-R01 module)

You should choose a program first before you set Insertion.

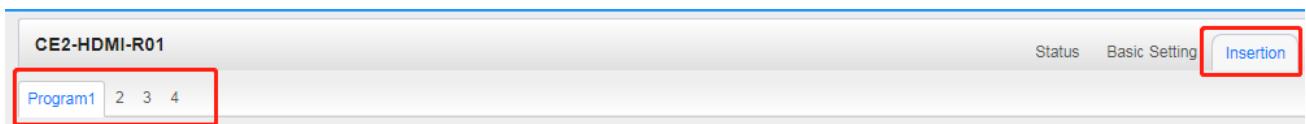

- **LOGO setting:** you can upload several pictures at the same time, and pick one to show on the screen. The field of the selected picture will turn green.

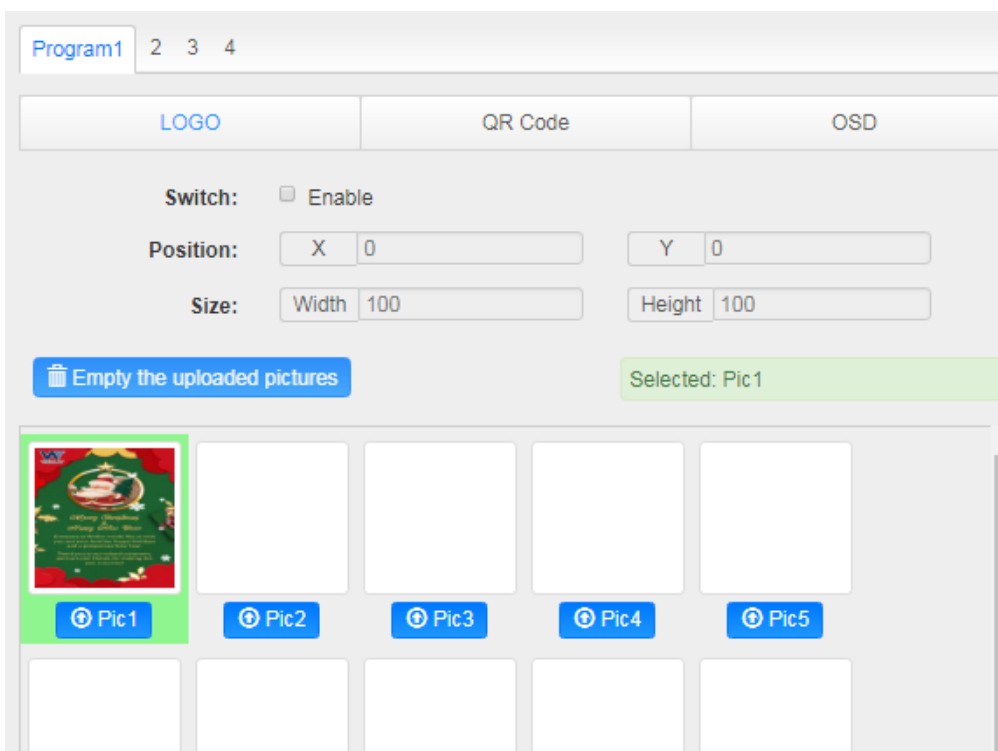

LOGO Parameter	Range	LOGO Parameter	Range
Position X	0~1920 (Dual)	Position Y	0~1080 (Dual)
Size width	0~1920 (Dual)	Size Height	0~1080 (Dual)

➤ **OSD setting:**

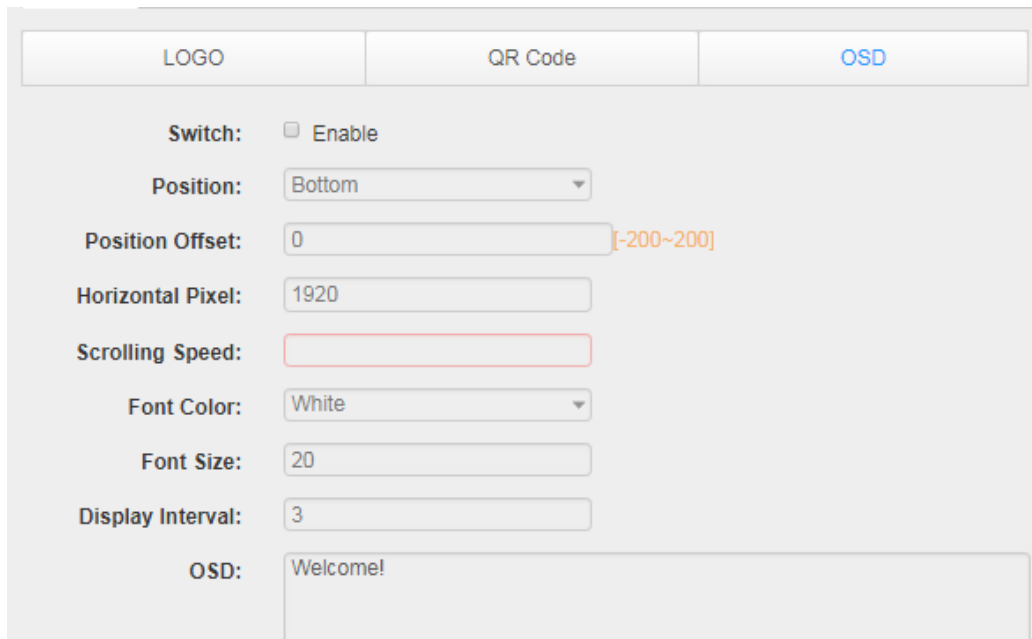

Subtitle Parameter	Range	LOGO Parameter	Range
Position	Bottom/Top/Middle	Position Offset	-200~200
Horizontal Pixel	10~1920	Scrolling Speed	1~20
Front Color	White/Black/Blue/Green/ Red/Yellow	Front Size	0~100
Display Interval	0~100		

➤ **QR Code setting:** QR Code picture picking method is same as LOGO setting.

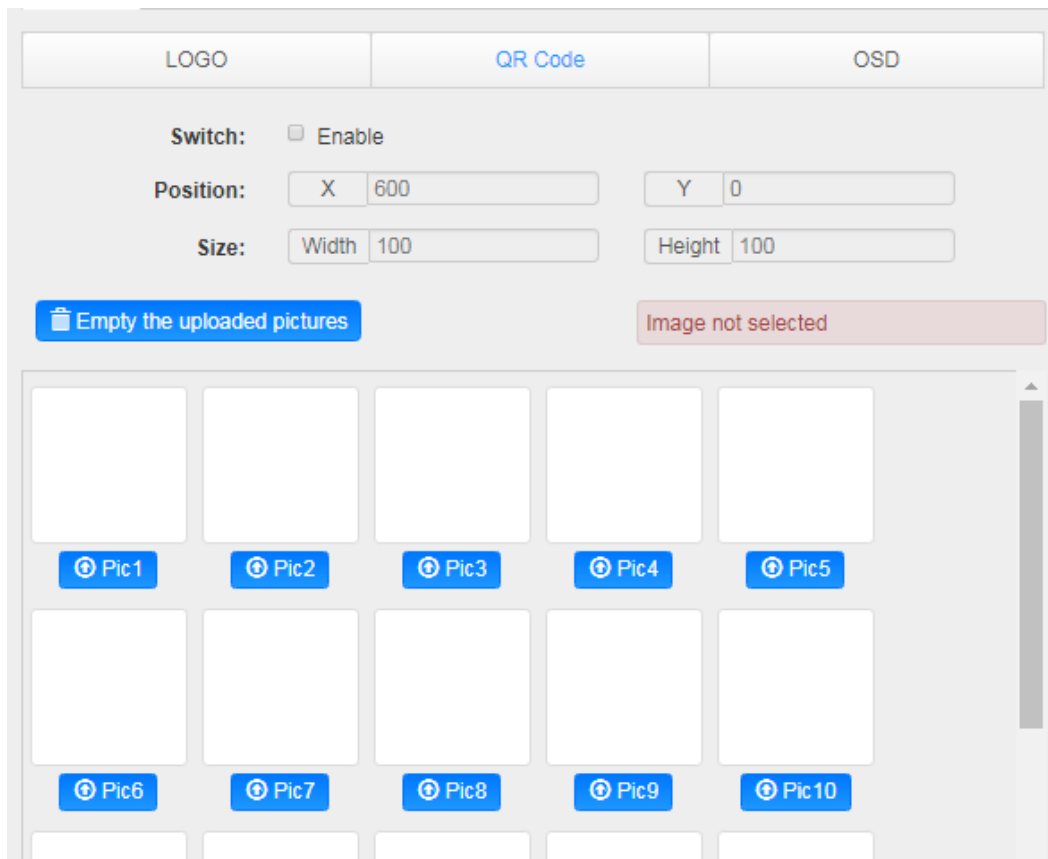

LOGO Parameter	Range	LOGO Parameter	Range
Position X	0~1920 (Dual)	Position Y	0~1080 (Dual)
Size width	0~1920 (Dual)	Size Height	0~1080 (Dual)

CE2-HDMI-00/R01 >System

Please refer to CR2-DVBC module.

5.2.2 CE2-HDMI-02

CE2-HDMI-02 is a 2-channel HDMI encoder which supports H.264 HD/SD or MPEG-2 HD/SD encoding with 2-channel RCA for CC input. The module supports MPEG1-L2, AAC and AC3 audio encoding.



CE2-HDMI-02 >Status

CE2-HDMI-02 Status Basic Setting Output System

HDCP turned on.

Program	Signal	HDCP Encryption	Input Video Resolution	Output Video Resolution	Video Bitrate(Mbps)	Audio Bitrate(Mbps)	Total Bitrate(Mbps)	Effective Bitrate(Mbps)	TS An
1	✘	Unencrypted	No_Video	No_Video	0.000	0.000	0.000	0.000	◀
2	✘	Unencrypted	No_Video	No_Video	0.000	0.000	0.000	0.000	◀

CE2-HDMI-02 >Basic Setting

CE2-HDMI-02 Status Basic Setting Output System

Basic Parameters Advanced Parameters

Advanced Setting >

Program	Input Source Type	Video Resolution	Video Encoding Format	Video Bitrate(Kbps)	Video Aspect Ratio	GOP Size	Profile	Audio Encoding Format	192
1	HDMI	Auto	H264	10000	Auto	18	High	AC3	192
2	HDMI	Auto	H264	10000	Auto	18	High	AC3	192

HDCP Test Mode: HDCP test mode is for test purposes only. Please make sure you have the right to use the content! Apply

Click **Basic Parameters** then click **Advanced Setting** to see **Video Parameters & Audio Parameters & Service Parameters** that you can modify and check what specific parameters you want to see and set. Click the **Apply** button on the right side to make the change take effect.

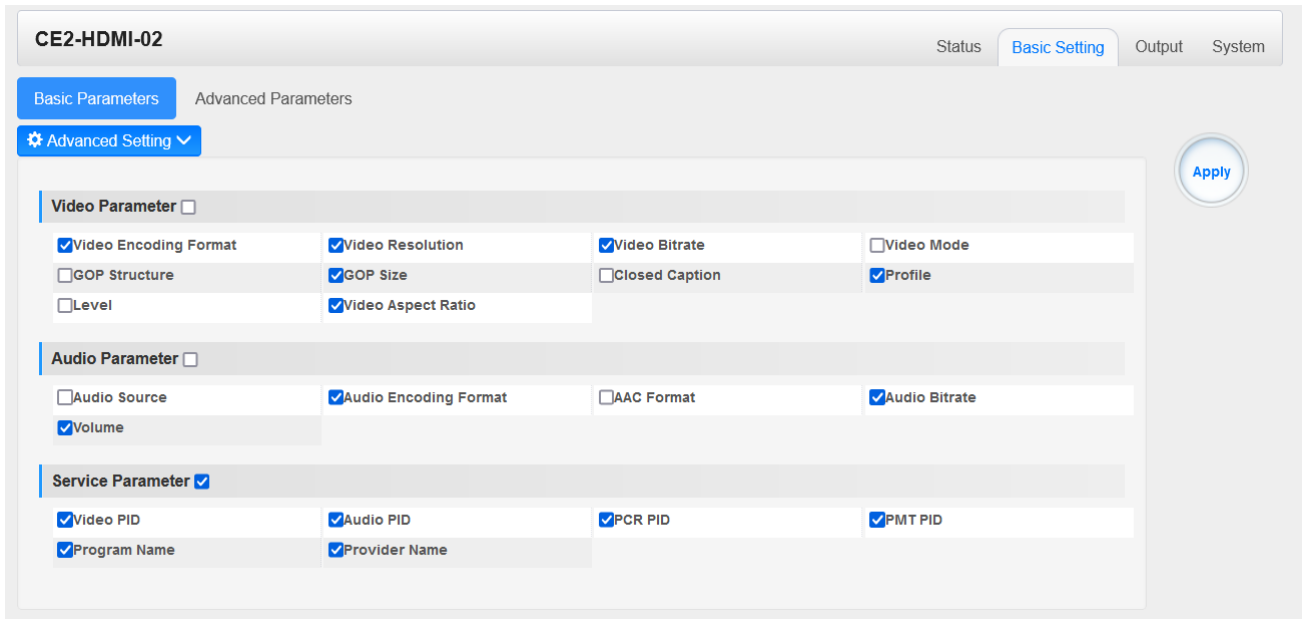

Setting Range:

Video Encode Settings	Range	Video Encode Settings	Range
Video Type	H264 , MPEG2	GOP Size	18~48
Video Bitrate (Kbps)	2000~18000	PCR2 PID	32~8190
Video Mode	CBR	PMT PID	32~8190
Video Max Bitrate (Kbps)	18000	Service Name	Length is 1~16
Video Min Bitrate (Kbps)	2000	Service Provider Name	Length is 1~16
CC	Enable Disable	Video PID	32~8190
Video PID	32~8190	Video Aspect Ratio	Auto 16x9 4x3
GOP Structure	IBBP, IPPP, IBP	P Frame	IBBP

P Frame: 5~15 IPPP

P Frame: 18~47
IBP

P Frame: 8~23

Audio Encode Settings	Range	Audio Encode Settings	Range
Audio Type	AC3	Volume	0~8
	AC3_Passthrough	AAC Format	ADTS
	MPEG1_Layer2		LATM
	MPEG2_AAC		
	MPEG4_AAC		
	AAC_HE_V2		
Audio Bitrate(Kbps)	128~384 (AC3)	Audio PID	32~8190
	64~384(MPEG1_Layer2/ MPEG2_AAC/ MPEG4_AAC/ AC3 Passthrough)		
	32~384(AAC_HE_V2)		



Click **Advance Parameters** to set **Encoding Parameters & Stream Output Parameters & MPEG-2 Output Parameters & MPEG4/MPEG4_AVC Output Parameters & Other Parameters** for CH1.1/CH2.1 separately.

CE2-HDMI-02 module supports up to two channels of audio and video input. Each channel includes 1 HDMI port and 1 RCA port. It supports dual audio encoding per channel which means one audio track from HDMI input can be encoded into two different formats for output.

CE2-HDMI-02 >Output

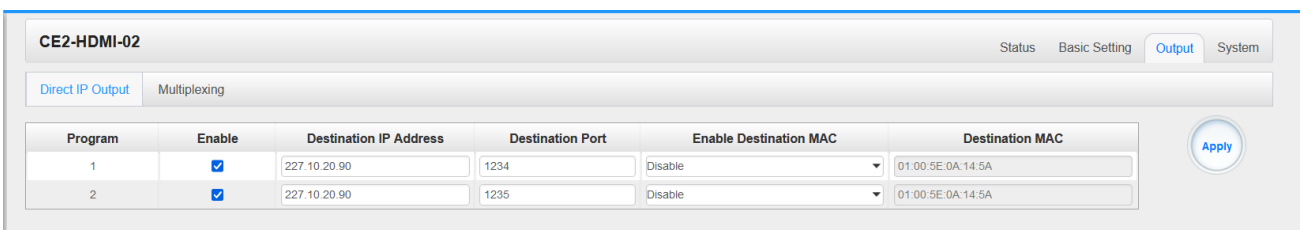

This feature is specifically for single program encoding and IP output directly. Outputting in this way will not occupy baseboard multicast bandwidth.



If you want to use IP output channels in the encoder module and the baseboard IP module at same time, you should avoid the multicast IP address conflict. If there are two same IP addresses enabled meantime, all the multicast videos will be affected.

- **Destination IP Address** and **Destination Port**: Using for multicast IP addresses or unicast IP addresses and ports.
- **Enable Destination MAC**: Generally, you do not need to enable this option. This is reserved for exceptional cases where the unicast stream cannot be received with unicast IP addresses. You can enable destination MAC and streaming out by setting Destination MAC.

To use **Multiplexing mode at service level**

1. Click on pencil icon . There will always be a Base Board selection for the IP output and other Output options depending on the module inserted.
2. Select the correct Output and Channel you want to output the service to.
3. Check Multiplex on the channel you want to output to. You can output multiple services to one channel or output one service to multiple channels.

CE2-HDMI-02 > System





Please refer to CR2-DVBC/DTMB module.

5.2.3 CE2-HDMI-02C

CE2-HDMI-02C is a 2-channel HDMI or component HD encoder. It supports H.264 / MPEG-2 HD/SD, MPEG1L2, AAC (optional), AC3 (optional) audio, CC subtitle and analog audio input.



CE2-HDMI-02C>Status

CE2-HDMI-02C													
										Status	Basic Setting	Output	System
HDCP turned on													
Progr...	Signal	HDCP Encry...	Input Video Resolution	Output Video Resolu...	Video Bitrate(Mb...	Audio Bitrate(Mb...	Total Bitrate(Mbps)	Effective Bitrate(Mb...	TS Anal...	Program Na...			
1	✘	Unencrypted	No_Video	No_Video	0.000	0.000	0.000	0.000		Program-1 			
2	✘	Unencrypted	No_Video	No_Video	0.000	0.000	0.000	0.000		Program-2 			

CE2-HDMI-02C>Basic Setting

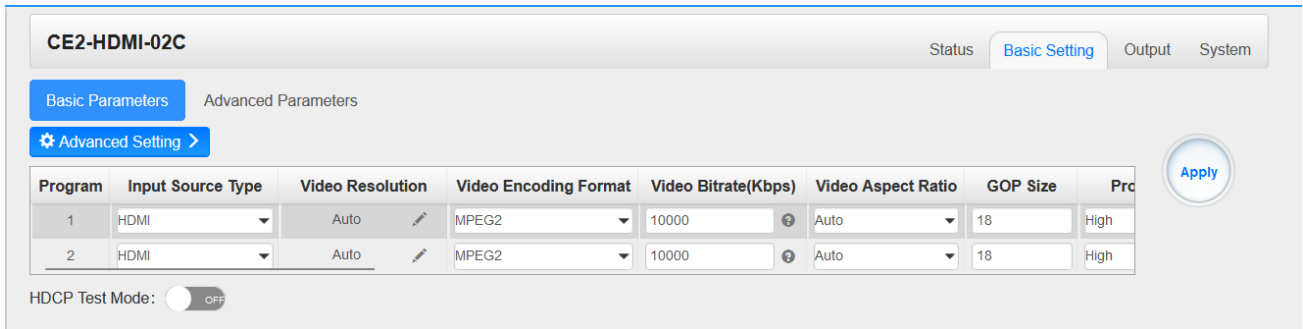

Click **Basic Settings** then click **Advance Settings** to see **Video Parameters & Audio Parameters & Service Parameters** where you can modify and check what specific parameters you want to see and set. Click the **Apply** button on the right side to make the change take effect.

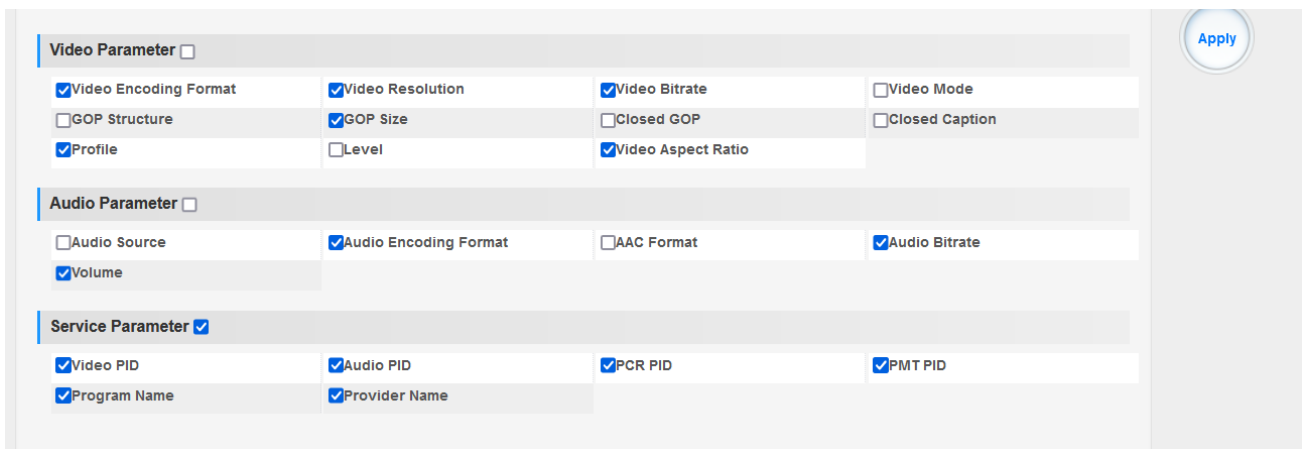

Setting Range:

Video Encode Settings	Range	Video Encode Settings	Range
Video Type	H264 , H265	GOP Size	18~48
Input Source Type	HDMI, Component	Level	3.0, 3.1, 3.2,4.0,4.1,4.2
Video Bitrate (Kbps)	2000~18000	PCR PID	32~8190
Video Mode	CBR	PMT PID	32~8190
Video Max Bitrate (Kbps)	18000	Service Name	Length is 1~16
Video Min Bitrate (Kbps)	2000	Service Provider Name	Length is 1~16

Closed Caption	Enable	Video PID	32~8190
	Disable		
Video PID	32~8190	Video Aspect Ratio	Auto
			16x9
			4x3
GOP Structure	IBBP, IPPP, IBP	Profile	High, Main, Baseline

Audio Encode Settings	Range	Audio Encode Settings	Range
Audio Type	AC3	Volume	0~8
	MPEG1_Layer2	AAC Format	ADTS
	MPEG2_AAC		LATM
	MPEG4_AAC		
Audio Source 1	HDMI	Audio Source 2	HDMI
	Analog		Analog
Audio Bitrate(Kbps)	128~384 (AC3)	Audio PID	32~8190
	64~384(MPEG1_Layer2/ MPEG2_AAC/ MPEG4_AAC/ AC3 Passthrough)		
	32~384(AAC_HE_V2)		
Volume	-20~20		

CE2-HDMI-02C> Output

CE2-HDMI-02C						Status	Basic Setting	Output	System
Direct IP Output		Multiplexing							
Program	Enable	Destination IP Address	Destination Port	Enable Destination MAC	Destination MAC				
1	<input checked="" type="checkbox"/>	227.100.200.90	1234	Disable	01:00:5E:64:C8:5A				
2	<input type="checkbox"/>	227.10.20.90	1235	Disable	00:00:00:00:00:00				

This feature is specifically for single program encoding and IP output directly. Outputting in this way will not occupy baseboard multicast bandwidth.



If you want to use IP output channels in the encoder module and baseboard TSoIP module at same time, you should avoid a multicast IP address conflict. If there are two same IP addresses enabled meantime, all the multicast video will be affected.

- **Destination IP Address** and **Destination Port**: Using for multicast IP addresses or unicast IP addresses and ports.
- **Enable Destination MAC**: Generally, you do not need to enable this option. This is reserved for exceptional cases where the unicast stream cannot be received with unicast IP addresses, you can enable destination MAC and streaming out by setting Destination MAC.

CE2-HDMI-02C				Status	Basic Setting	Output	System
Direct IP Output		Multiplexing					
Program	Program Name	Destination		Destination Setting			
1	Program-1			✎			
2	Program-2			✎			

To use **Multiplexing mode at service level**:

1. Click on the pencil icon ✎ . There will always be a Base Board selection for the IP output and other Output options depending on the module inserted.
2. Select the correct Output and Channel you want to output the service to.
3. Check Multiplex on the channel you want to output to. You can output multiple services to one channel or output one service to multiple channels.

CE2-HDMI-02C> System

Please refer to CR2-DVBC/DTMB module.

5.2.4 CE2-HDMI-06B

4CH HDMI HD encoding board (broadcast grade), support H.264 HD/SD, support B frame, MPEG1L2 (support), AAC (optional), AC3 (optional).

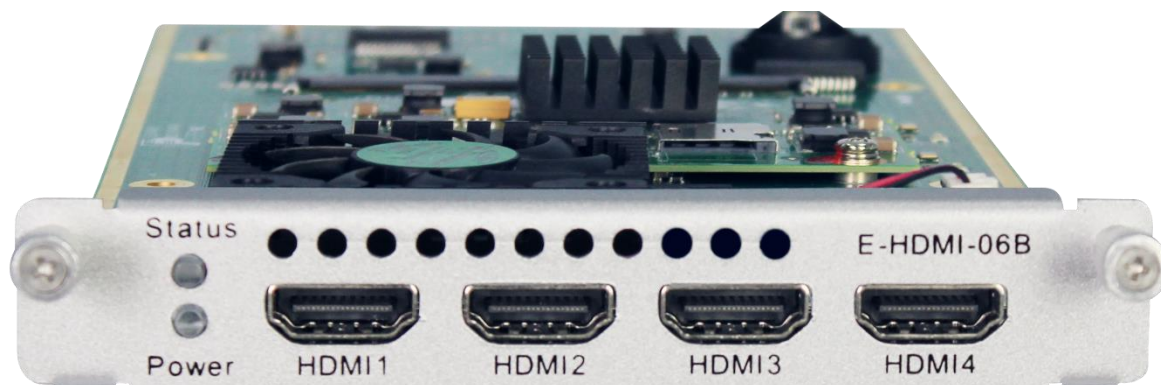

CE2-HDMI-06B>Status

Status page for CE2-HDMI-06B shows the following parameters: **Program, Signal, HDCP Encryption, Input Video Resolution, Output Video Resolution, Total Bitrate, Effective Bitrate, TS analysis** and **Program Name**. The following parameters will display values once a good HDMI source is connected.

Program	Signal	HDCP Encryption	Input Video Resolution	Output Video Resolution	Total Bitrate(Mbps)	Effective Bitrate(Mbps)	TS Analysis	Program Name
1	✓	Unencrypted	1920x1080_59.94p	1920x1080_30p	8.548	8.548	👁	Program-01 ⓘ
2	✓	Unencrypted	1920x1080_59.94p	1920x1080_30p	8.559	8.559	👁	Program-02 ⓘ
3	✓	Unencrypted	1920x1080_59.94p	1920x1080_30p	8.548	8.548	👁	Program-03 ⓘ
4	✓	Unencrypted	1920x1080_59.94p	1920x1080_30p	8.559	8.559	👁	Program-04 ⓘ

CE2-HDMI-06B>Basic Setting

Program	Video Encoding Format	Video Bitrate(Kbps)	Audio Encoding Format	Audio Bitrate(Kbps)	Audio Sampling...	Volume(dB)	Delay(ms)	Audio PID	S
1	H.264	3000	MPEG1_Layer2	128	48	0	0	103	Disat
2	H.264	8000	MPEG1_Layer2	128	48	0	0	203	Disat
3	H.264	8000	MPEG1_Layer2	128	48	0	0	303	Disat
4	H.264	8000	MPEG1_Layer2	128	48	0	0	403	Disat

HDCP Test Mode: ON ⓘ HDCP test mode is for test purposes only. Please make sure you have the right to use the content!

Associated Mode: OFF

Click **Basic Settings** then click **Advance Settings** to see **Video Parameters & Audio Parameters & Service Parameters** where you can modify and check what specific parameters you want to see and set. Click the **Apply** button on the right side to make the change take effect.

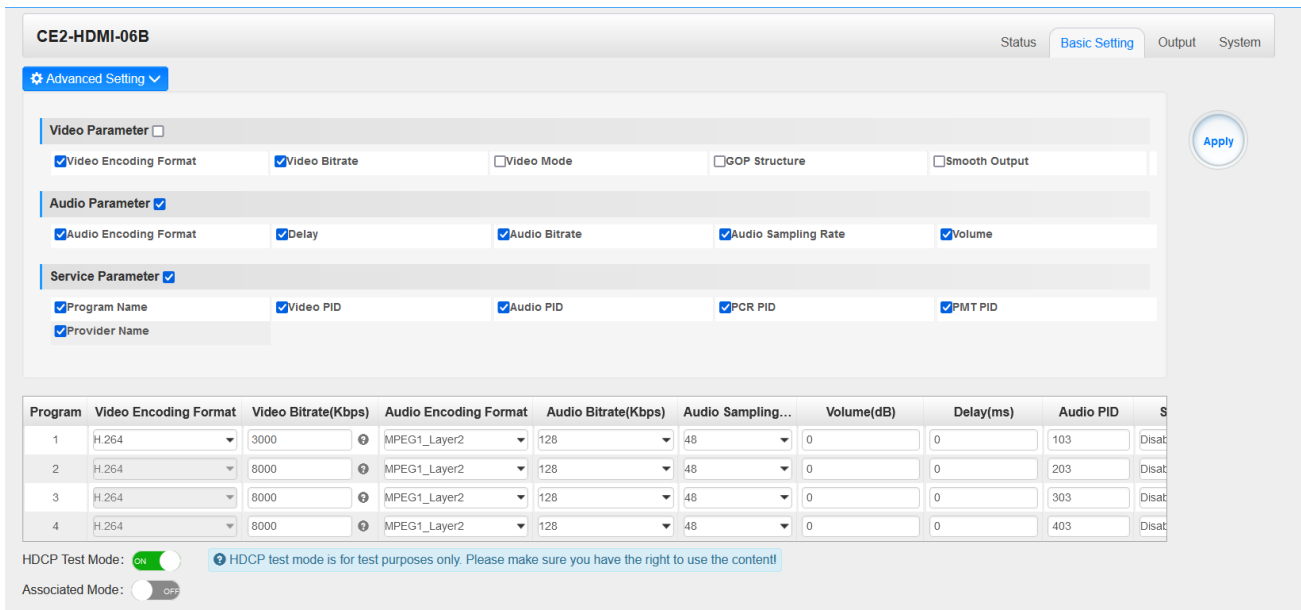

Setting Range:

Video Encode Settings	Range	Name	Range
Input TS Source	HDMI		
Video Type	H264 , H.264	Smooth output	Enable/Disable
Video Bitrate (Kbps)	2000~18000	PCR PID	32~8190
Video Mode	CBR	PMT PID	32~8190
Video Max Bitrate (Kbps)	18000	Service Name	Length is 1~16
Video Min Bitrate (Kbps)	2000	Service Provider Name	Length is 1~16
Video PID	32~8190		
GOP Structure	IBBP, IPPP		

Audio Encode Settings	Range	Audio Encode Settings	Range
Input Source Type	HDMI	Audio Bit Rate(Kbps)	128~384 (AC3) 64~384(MPEG1_Lay
Audio Type	AC3 MPEG1_Layer2 AAC		er2/MPEG2_AAC/ AC3_Passthrough/ MPEG4_AAC)
Audio Sampling Rate	48 Auto	Delay (ms)	32~384(AAC_HE_V2) -2000~2000
Volume	-20~20	Audio PID	32~8190

CE2-HDMI-06B> Output

CE2-HDMI-06B Status Basic Setting **Output** System

Direct IP Output Multiplexing

Program	Enable	Destination IP Address	Destination Port	Enable Destination MAC	Destination MAC
1	<input checked="" type="checkbox"/>	227.10.20.80	1111	Disable	01:00:5E:0A:14:50
2	<input type="checkbox"/>	227.10.20.90	1235	Disable	01:00:5E:0A:14:5A
3	<input type="checkbox"/>	227.10.20.90	1236	Disable	01:00:5E:0A:14:5A
4	<input type="checkbox"/>	227.10.20.90	1237	Disable	01:00:5E:0A:14:5A

This feature is specifically for single program encoding and IP output directly. Outputting in this way will not occupy baseboard multicast bandwidth.



If you want to use IP output channels in the encoder module and baseboard TSolP module at same time, you should avoid a multicast IP address conflict. If there are two same IP addresses enabled meantime, all the multicast video will be affected.

- **Destination IP Address** and **Destination Port**: Using for multicast IP addresses or unicast IP addresses and ports.
- **Enable Destination MAC**: Generally, you do not need to enable this option. This is reserved for exceptional cases where the unicast stream cannot be received with unicast IP addresses, you can enable destination MAC and streaming out by setting Destination MAC.

CE2-HDMI-06B
Status Basic Setting **Output** System

Direct IP Output
Multiplexing

Program	Program Name	Destination	Destination Setting
1	Program-01	17.Baseboard[1.1]	✎
2	Program-02		✎
3	Program-03		✎
4	Program-04		✎

Apply
Clear Config

To use **Multiplexing mode at service level**:

4. Click on the pencil icon ✎ . There will always be a Base Board selection for the IP output and other Output options depending on the module inserted.
5. Select the correct Output and Channel you want to output the service to.
6. Check Multiplex on the channel you want to output to. You can output multiple services to one channel or output one service to multiple channels.

CE2-HDMI-06B> System

Please refer to CR2-DVBC/DTMB module.

5.2.5 CE2-SDI-01

CE2-SDI-01 module supports 2-channel SDI HD encoding board, support H.264/MPEG-2 HD/SD, MPEG1L2 (support), AAC (support), AC3 (support), support CC subtitles



CE2-SDI-01>Status

Status page for CE2-SDI-00 shows the following parameters: **Program, Signal, Input Video Resolution, Output Video Resolution, Video Bitrate, Audio Bitrate, Total Bitrate, Effective Bitrate, TS analysis** and **Program Name**. The following parameters will display values once a good SDI source is connected.

CE2-SDI-01							
Program	Signal	Input Video Resolution	Output Video Resolution	Video Bitrate(Mbps)	Audio Bitrate(Mbps)	Total Bitrate(Mbps)	Effective Bitrate(Mbps)
1	✓	1920x1080_50i	1920x1080_50i	9.597	0.248	9.771	9.845
2	✗	No_Video	No_Video	0.000	0.000	0.000	0.000

CE2-SDI-01 >Basic Setting

CE2-SDI-01		
Program	Video Encoding Format	Video Bitrate(Kbps)
1	MPEG2	10000
2	MPEG2	10000

Buttons: Basic Parameters, Advanced Parameters, Advanced Setting >, Apply

Click **Basic Parameters** then click **Advanced Setting** to see **Video Parameters & Audio Parameters & Service Parameters** where you can modify and check what specific parameters you want to see and set. Click the **Apply** button on the right side to make the change take effect.

CE2-SDI-01 Status **Basic Setting** Output System

Basic Parameters Advanced Parameters

Advanced Setting Apply

Video Parameter

<input checked="" type="checkbox"/> Video Encoding Format	<input type="checkbox"/> Video Resolution	<input checked="" type="checkbox"/> Video Bitrate	<input type="checkbox"/> Video Mode
<input type="checkbox"/> GOP Structure	<input type="checkbox"/> GOP Size	<input type="checkbox"/> Closed GOP	<input type="checkbox"/> Closed Caption
<input type="checkbox"/> Profile	<input type="checkbox"/> Level	<input type="checkbox"/> Video Aspect Ratio	<input type="checkbox"/> Smooth Output

Audio Parameter

<input type="checkbox"/> Audio Source	<input type="checkbox"/> Audio Encoding Format	<input type="checkbox"/> AAC Format	<input type="checkbox"/> Audio Bitrate
<input type="checkbox"/> Volume			

Service Parameter

<input type="checkbox"/> Video PID	<input type="checkbox"/> Audio PID	<input type="checkbox"/> PCR PID	<input type="checkbox"/> PMT PID
<input type="checkbox"/> Program Name	<input type="checkbox"/> Provider Name		

Program	Video Encoding Format	Video Bitrate(Kbps)
1	MPEG2	10000
2	MPEG2	10000

Setting Range

Video Encode Settings	Range	Video Encode Settings	Range
Input Source Type	CVBS, SDI	GOP Size	18~48
Video Type	H264 , MPEG2	PCR2 PID	32~8190
Video Bit Rate (Kbps)	2000~18000	PMT PID	32~8190
Video Mode	CBR	Program Name	Length is 1~31
CC	Disable, Enable	Provider Name	Length is 0~31
Video PID	32~8190	Video Aspect Ratio	Auto 16x9 4x3
GOP Structure	IPPB, IPPP, IBP	P Frame	IBBP P Frame: 5~15 IPPP P Frame: 18~47 IBP

Audio Encode Settings	Range	Audio Encode Settings	Range
Input Source Type	SDI	Audio Bit Rate(Kbps)	128~384 (AC3)
	CVBS		64~384(MPEG1_Lay
Audio Source	SDI1(2/3/4)		er2/MPEG2_AAC/
	Analog		AC3_Passthrough)
Audio Type	AC3		16~384(MPEG4_AA
	AC3_Passthrough	Audio AAC Format	C)
	MPEG1_Layer2		ADTS
	MPEG2_AAC		LATM
	MPEG4_AAC		
Volume	-20~20	Audio PID	32~8190



Click **Advance Parameters** to set **Encoding Parameters & Stream Output Parameters & MPEG-2 Output Parameters & MPEG4/MPEG4_AVC Output Parameters & Other Parameters** for CH1.1/CH2.1 separately.

CE2-SDI-01>Output

Program	Enable	Destination IP Address	Destination Port	Enable Destination MAC	Destination MAC
1	<input checked="" type="checkbox"/>	227.10.20.90	1234	Disable	01:00:5E:0A:14:5A
2	<input type="checkbox"/>	227.10.20.90	1235	Disable	00:00:00:00:00:00

This feature is specifically for single program encoding and IP output directly. Outputting in this way will not occupied baseboard multicast bandwidth.



If you want to use IP output channel in the encoder module and baseboard TSoIP module at same time, you should avoid a multicast IP address conflict. If there are two same IP addresses enabled meantime, all the multicast videos will be affected.

- **Destination IP Address** and **Destination Port**: Using for multicast IP addresses or unicast IP addresses and ports.
- **Enable Destination MAC**: Generally, you do not need to enable this option. This is reserved for exceptional case when the unicast stream cannot be received by using unicast IP addresses, you can enable destination MAC and streaming out by setting Destination MAC.

To use **Multiplexing mode at service level**:

1. Click on the pencil icon . There will always be a Base Board selection for the IP output and other Output options depending on the module inserted.
2. Select the correct Output and Channel you want to output the service to.
3. Check Multiplex on the channel you want to output to. You can output multiple services to one channel or output one service to multiple channels.

The second eth is reserved to output IP streams in another different VLAN. Enabling the second eth and set **IP Address**, **Subnet Mask**, **Default Gateway** in the same segment of the Unicast IP (the another different VLAN), you can output the Unicast stream to the another VLAN.

CE-SDI-01 >System

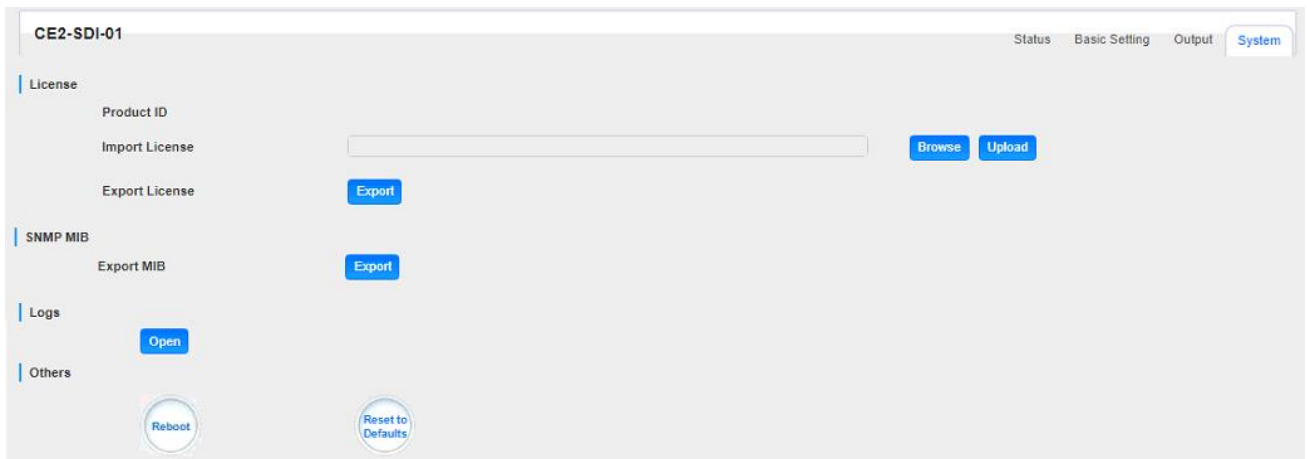

5.2.6 CE2-CVBS-00

CE2-CVBS-00 is a 6-channel CVBS encoder with 2 DB15 connectors each for 3 channels. It supports H.264/MPEG-2 SD encoding and MPEG1-L2, AAC (optional) and AC3(optional) audio.



CE2-CVBS-00

Configuration is similar to CE2-HDMI module. Please refer to that module section.

CE2-CVBS-00 >Settings

CE2-CVBS-00										
							Status	Basic Setting	Output	System
Program	Video Resolution	Video Bitrate(Mbps)	Audio Bitrate(Mbps)	Total Bitrate(Mbps)	Effective Bitrate(Mbps)	TS Analysis	Program Name			
1	No_Video	0.000	0.000	0.000	0.000		Program-1			
2	No_Video	0.000	0.000	0.000	0.000		Program-2			
3	No_Video	0.000	0.000	0.000	0.000		Program-3			
4	No_Video	0.000	0.000	0.000	0.000		Program-4			
5	No_Video	0.000	0.000	0.000	0.000		Program-5			
6	No_Video	0.000	0.000	0.000	0.000		Program-6			

Click **Advanced Setting** to see all parameters you can modify and check what specific parameters you want to see and set. Click the **Apply** button on the right side to make the change take effect.

CE2-CVBS-00										
							Status	Basic Setting	Output	System
Advanced Setting >										
Program	Video Encoding Format				Video Bitrate					
1	H264				5000					
2	H264				2000					
3	H264				2000					
4	H264				5000					
5	H264				5000					
6	H264				5000					

Setting range:

Video Encode Settings	Range	Video Encode Settings	Range
Video Type	H264 , MPEG2	Service Name	Length is 1~16
Video Bitrate (Kbps)	600~20000	Service Provider Name	Length is 1~16
Video Mode	CBR, VBR	Brightness	0~255
Video Max Bitrate (Kbps)	0	Contrast	0~255
Video Min Bitrate (Kbps)	20000	Saturation	0~255
Video PID	32~8190	Hue	-180~180
GOP Structure	IPPB, IPPP, IBP	VLC Mode	CABAC CAVLC

GOP Size	6~63	Profile	HIGH / MAIN (H.264) MAIN (MPEG-2)
GOP Close	Disable, Enable	Level	3.0,3.1,3.2
PCR2 PID	32~8190	Video Aspect Ratio	Auto 16x9_LetterBox 16x9_CutOff 4x3_PillarBox 4x3_CutOff
PMT PID	32~8190		

Audio Encoder Details	Range	Audio Encoder Details	Range
Encoding Type	MPEG1_Layer2	Audio Sampling Bitrate(KHz)	48
Audio Mode (AC3)	Dual Channel/Mono/ Stereo	Audio PID	32~8190
Encoding Bitrate(Kbps)	64~384	Volume Setting	0.00~8.00

CE2-CVBS-00 > Output/ Insertion

Output and ***Insertion*** please refer to CE2-HDMI-R01 module.

CE2-CVBS-00 > System

Please refer to CR2-DVBC module.

5.2.7 CE2-HDMI-R05/R05A

CE2-HDMI-R05/R05A is a 4/8-channel HDMI high-definition encoding board (commercial level), supports H.264/H.265 HD/SD (supports up to 1080p60 input for R05 and 1080p30 for 05), MPEG1L2 (support), AC3 (optional), AAC (optional), supports superimposed OSD subtitles, Logo, QR code.



CE2-HDMI-R05>Status

CE2-HDMI-R05

Status
Basic Setting
Insertion
Output
System

HDCP turned off. ✕

Program	Signal	HDCP Encryption	Input Video Resolution	Output Video Resolution	Total Bitrate(Mbps)	Effective Bitrate(Mbps)	TS Analysis	Program Name
1	✓	Unencrypted	1920x1080_50i	1920x1080_25p	8.938	8.938	👁	Program-01
2	✗	Unencrypted	No_Video	No_Video	0.000	0.000	👁	Program-02
3	✗	Unencrypted	No_Video	No_Video	0.000	0.000	👁	Program-03
4	✗	Unencrypted	No_Video	No_Video	0.000	0.000	👁	Program-04

CE2-HDMI-R05 >Basic Setting

CE2-HDMI-R05

Status
Basic Setting
Insertion
Output
System

⚙️
Advanced Setting >

Program	Video Encoding Format	Video Bitrate(Kbps)	Video Resolution	GOP Size	Profile	Video Aspect Ratio	Audio Encoding Format
1	H.264	8000	Auto	25	Main	Automatic	MPEG1_Layer2
2	H.264	8000	Auto	25	Main	Automatic	MPEG1_Layer2
3	H.264	8000	Auto	25	Main	Automatic	MPEG1_Layer2
4	H.264	8000	Auto	25	Main	Automatic	MPEG1_Layer2

Apply

HDCP Test Mode : on off

This page allows you to modify the Video, Audio and Service Parameters. Click **Advanced Setting** to see all parameters you can modify and check what specific parameters you want to set and see. Click the **Apply** button on the right side to make the change take effect.

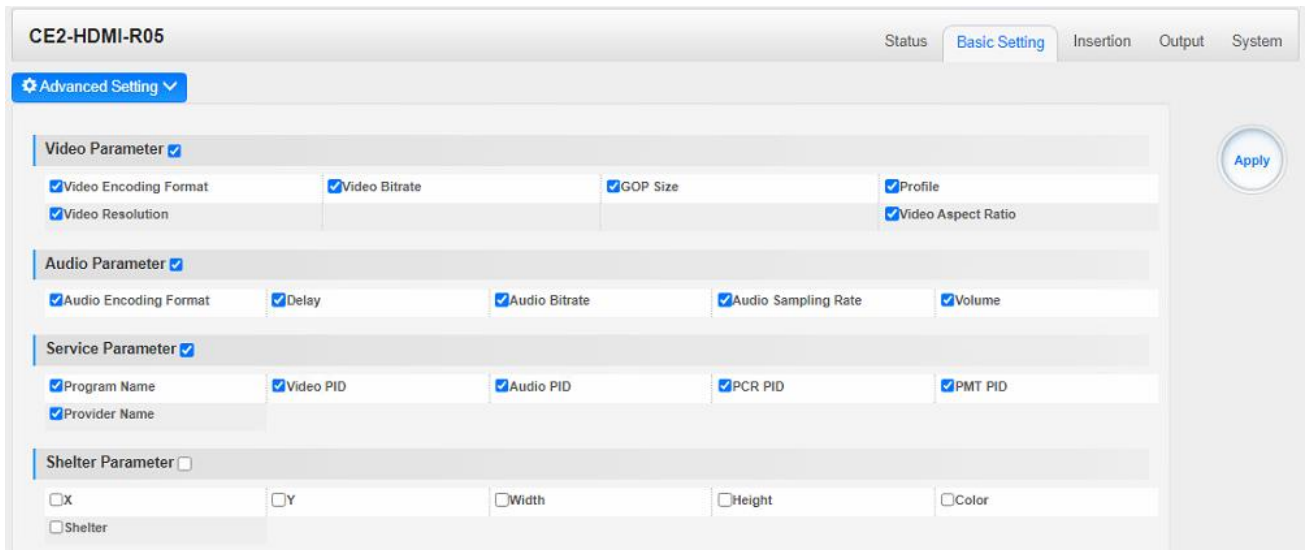

Name	Range	Name	Range
Video Type	H.264 , H.265	Video PID	32~8190
Video Bitrate (Kbps)	600~12000	PCR2 PID	32~8190
GOP Size	1~60	PMT PID	32~8190
Video Resolution	Auto , Manual (Horizontal Pixels: 160~1920, Vertical Pixels: 120~1080, Framerate: 24~60, Scan Type: Progressive)	Program Name	Length is 1~31
Video Aspect Ratio	Automatic , 16x9 (SD) , 4x3 (SD)	Provider Name	Length is 0~31
Profile	MAIN HIGH		

Click **Service Info** in the line of Audio Encoding to set audio encoding.

Audio Encoder Details	Range	Audio Encoder Details	Range
-----------------------	-------	-----------------------	-------

Audio Enable	Enable/Disable	Delay(ms)	-2000~2000
Audio Type	MPEG1_Layer2 AAC AC3	Audio Bitrate(Kbps)	32~192(MPEG1_Layer2) 32~192(AAC) 96~192 (AC3)
Volume(dB)	-20~20	Audio PID	32~8190

Shelter Parameters	Range	Shelter Parameters	Range
Shelter	Enable/Disable	X	0~1920 (Dual)
Y	0~1080 (Dual)	Width	2~1920 (Dual)
Height	2~1080 (Dual)	Color	White/Black/Blue/Green/Red

CE2-HDMI-R05 >Output

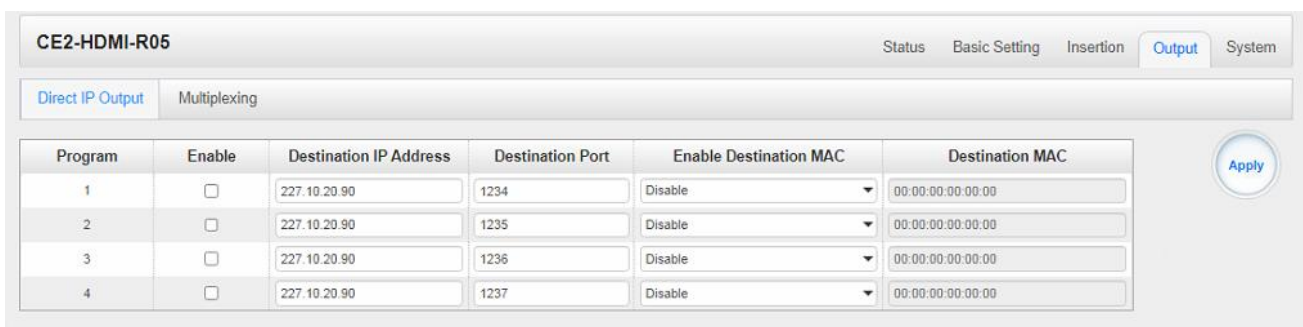

This feature is specifically for single program encoding and IP output directly. Outputting in this way will not occupy baseboard multicast bandwidth.



If you want to use IP output channel in the encoder module and baseboard IP Output module at same time, you should avoid the multicast IP address conflict. If there are two same IP addresses enabled meantime, all the multicast videos will be affected.

- **Destination IP Address** and **Destination Port**: Using for multicast IP addresses or unicast IP addresses and ports.
- **Enable Destination MAC**: Generally, you do not need to enable this option. This is reserved for exceptional cases where the unicast stream cannot be received with unicast IP addresses You can enable destination MAC and streaming out by setting Destination MAC.

CE2-HDMI-R05 >Insertion

You should choose a program first before you set Insertion.

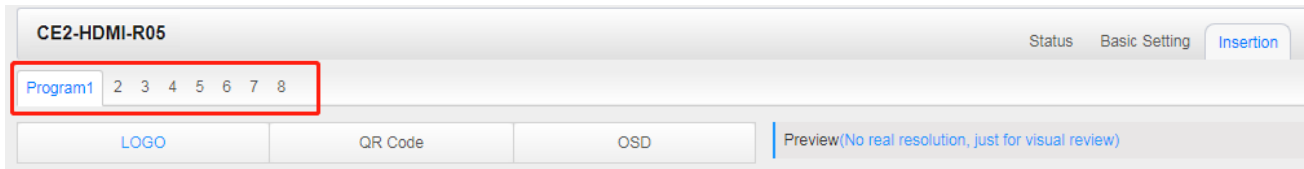

You can preview the effect or make adjustment after you set Insertion.

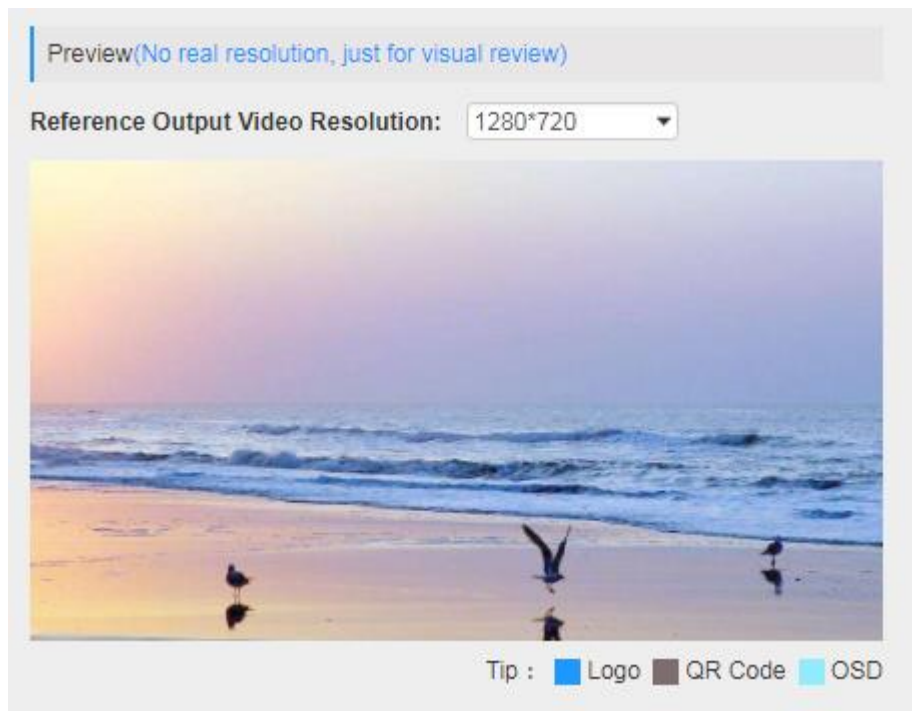

- **LOGO setting:** you can upload several pictures at the same time, and pick one to show on the screen. The field of the selected picture will turn green.

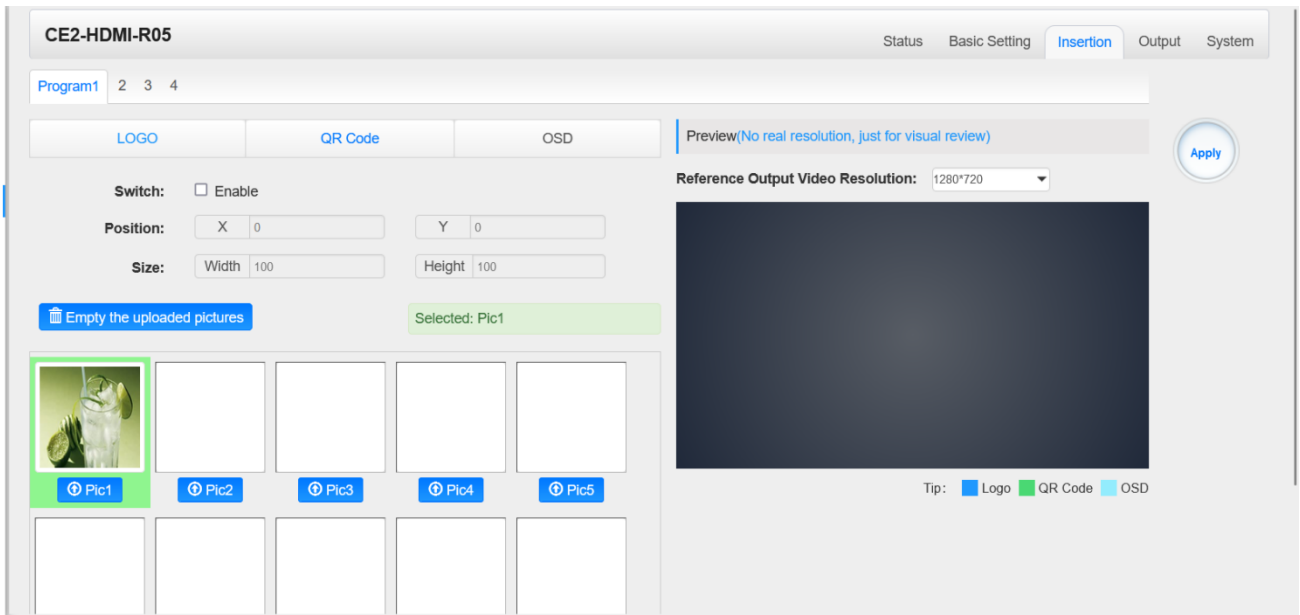

LOGO Parameter	Range	LOGO Parameter	Range
Position X	0~1920 (Dual)	Position Y	0~1080 (Dual)
Size width	2~1920 (Dual)	Size Height	2~1080 (Dual)

➤ **OSD setting:**

CE2-HDMI-R05

Program1
2
3
4

LOGO
QR Code
OSD

Switch: Enable

Position: Bottom ▼

Position Offset: 0 [-200~200]

Horizontal Pixel: 1920

Scrolling Speed: 1

Font Color: White ▼

Font Size: 20

Background Color: Black ▼

Background Transparency: 0

OSD:

Welcome!

Subtitle Parameter	Range	LOGO Parameter	Range
Position	Bottom/Top/Middle	Position Offset	-200~200
Horizontal Pixel	10~1920	Scrolling Speed	1~20
Front Color	White/Black/Blue/Green/ Red/Yellow	Front Size	0~100

➤ **QR Code setting:** QR Code picture picking method is same as LOGO setting.

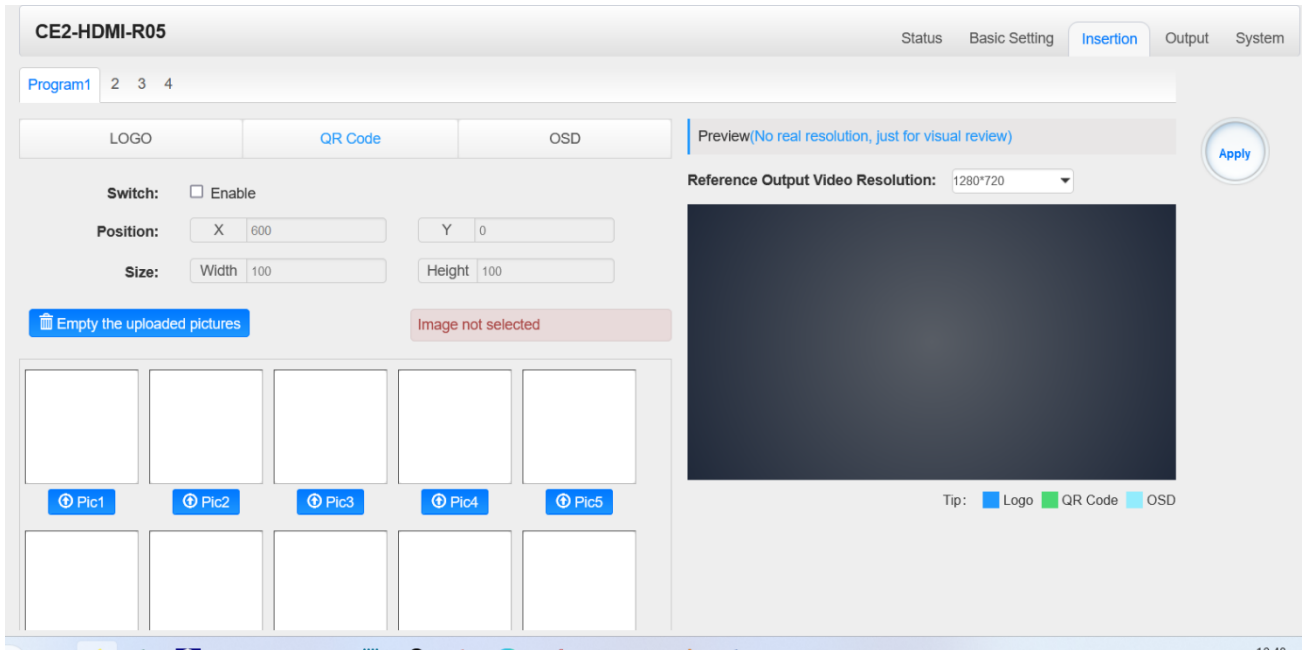

QR Code Parameter	Range	QR Code Parameter	Range
Position X	0~1920 (Dual)	Position Y	0~1080 (Dual)
Size width	0~1920 (Dual)	Size Height	0~1080 (Dual)

CE2-HDMI-05A >Output

Output configuration please refer to CR2-DVBC module.

CE2-HDMI-05A > System

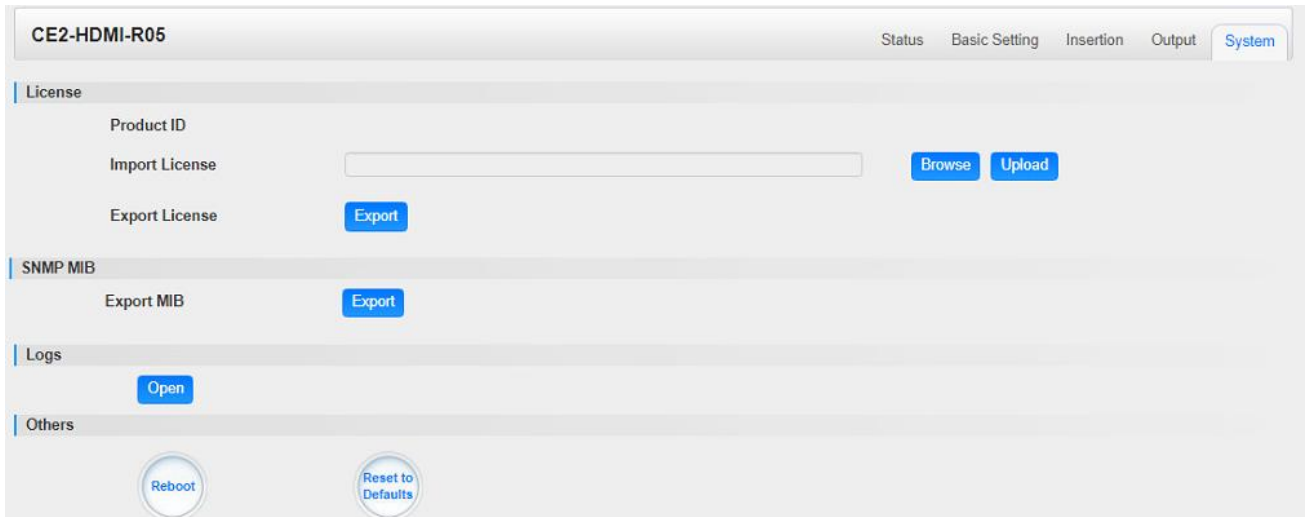

On **System** page you can **Import/Export License**, **Reboot** module, **Reset to Defaults** and Manage **Logs**.

5.2.8 CE2-HDMI-06

CE2-HDMI-06 is a 4-channel HDMI high-definition encoding board (broadcast level), support H.264/H.265 HD/SD, support B frame, MPEG1L2 (support), AAC (optional), AC3 (optional), support superimposed OSD subtitles, logo, two-dimensional Code.

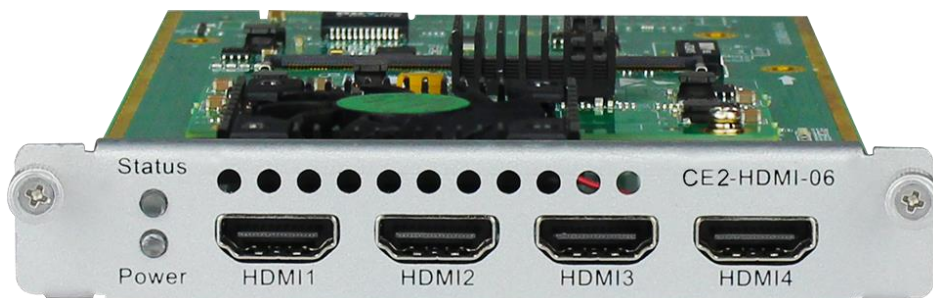

CE2-HDMI-06>Status

CE2-HDMI-06
Status Basic Setting Insertion Output System

HDCP turned on

Program	Signal	HDCP Encryption	Input Video Resolution	Output Video Resolution	Total Bitrate(Mbps)	Effective Bitrate(Mbps)	TS Analysis	Program Name
1	✘	Unencrypted	No_Video	No_Video	0.000	0.000	👁	Program-01 ⓘ
2	✘	Unencrypted	No_Video	No_Video	0.000	0.000	👁	Program-02 ⓘ
3	✘	Unencrypted	No_Video	No_Video	0.000	0.000	👁	Program-03 ⓘ
4	✘	Unencrypted	No_Video	No_Video	0.000	0.000	👁	Program-04 ⓘ

CE2-HDMI-06>Basic Setting

CE2-HDMI-06
Status Basic Setting Insertion Output System

⚙️ Advanced Setting >

Program	Video Encoding Format	Video Bitrate(Kbps)
1	H.264	12000
2	H.264 H.265	12000
3	H.264	12000
4	H.264	12000

Apply

HDCP Test Mode : ON
ⓘ HDCP test mode is for test purposes only. Please make sure you have the right to use the content!

This page allows you to modify the Video, Audio and Service Parameters. Click **Advanced Setting** to see all parameters you can modify and check what specific parameters you want to see and set. Click the **Apply** button on the right side to make the change take effect.

CE2-HDMI-06
Status Basic Setting Insertion Output System

⚙️ Advanced Setting ▾

Video Parameter
Apply

Video Encoding Format
 Video Bitrate
 Video Mode
 GOP Structure
 Smooth Output

Audio Parameter

Audio Encoding Format
 Delay
 Audio Bitrate
 Audio Sampling Rate
 Volume

Service Parameter

Program Name
 Video PID
 Audio PID
 PCR PID
 PMT PID

Provider Name

Shelter Parameter

X
 Y
 Width
 Height
 Color

Shelter

Name	Range	Name	Range
Video Type	H.264 , H.265	Video PID	32~8190
Video Bitrate (Kbps)	600~12000	PCR2 PID	32~8190
GOP Size	1~60	PMT PID	32~8190
Video Resolution	Auto , Manual (Horizontal Pixels: 160~1920, Vertical Pixels: 120~1080, Framerate: 24~60, Scan Type: Progressive)	Program Name	Length is 1~31
Video Aspect Ratio	Automatic , 16x9 (SD) , 4x3 (SD)	Provider Name	Length is 0~31
Profile	MAIN HIGH	Smooth Output	Enable, Disable

Audio Encoder Details	Range	Audio Encoder Details	Range
Audio Enable	Enable/Disable	Delay(ms)	-2000~2000
Audio Type	MPEG1_Layer2 AAC AC3	Audio Bitrate(Kbps)	32~192(MPEG1_Layer2) 32~192(AAC) 96~192 (AC3)
Volume(dB)	-20~20	Audio PID	32~8190

Shelter Parameters	Range	Shelter Parameters	Range
Shelter	Enable/Disable	X	0~1920 (Dual)
Y	0~1080 (Dual)	Width	2~1920 (Dual)
Height	2~1080 (Dual)	Color	White/Black/Blue/Green/Red

CE2-HDMI-06>Output

CE2-HDMI-06						Status	Basic Setting	Insertion	Output	System
Direct IP Output		Multiplexing								
Program	Enable	Destination IP Address	Destination Port	Enable Destination MAC	Destination MAC					
1	<input checked="" type="checkbox"/>	227.10.20.94	1234	Enable	01:00:5E:0A:14:5E					
2	<input type="checkbox"/>	227.10.20.94	1235	Enable	01:00:5E:0A:14:5E					
3	<input type="checkbox"/>	227.10.20.94	1236	Disable	01:00:5E:0A:14:5E					
4	<input type="checkbox"/>	227.10.20.94	1237	Disable	01:00:5E:0A:14:5E					

This feature is specifically for single program encoding and IP output directly. Outputting this way will not occupy baseboard multicast bandwidth.



If you want to use IP output channels in the encoder module and baseboard IP Output module at same time, you should avoid a multicast IP address conflict. If there are two same IP addresses enabled meantime, all the multicast videos will be affected.

- **Destination IP Address** and **Destination Port**: Using for multicast IP addresses or unicast IP addresses and ports.
- **Enable Destination MAC**: Generally, you do not need to enable this option. This is reserved for exceptional cases where the unicast stream cannot be received with unicast IP addresses you can enable destination MAC and streaming out by setting Destination MAC.

CE2-HDMI-06				Status	Basic Setting	Insertion	Output	System
Direct IP Output		Multiplexing						
Program	Program Name	Destination	Destination Setting					
1	Program-01	15.[1.1]						
2	Program-02							
3	Program-03							
4	Program-04							

To use **Multiplexing mode at service level**:

1. Click on (pencil) icon. There will always be a Base Board selection for the IP output and other Output options depending on the module inserted.
2. Select the correct Output and Channel you want to output the service to.

Check Multiplex on the channel you want to output to. You can output multiple services to one channel or output one service to multiple channels.

CE2-HDMI-06>Insertion

You should choose program first before you set Insertion.

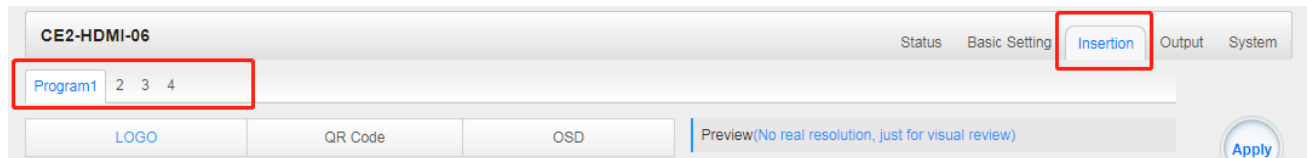

You can preview the effect or make adjustment after you set Insertion.

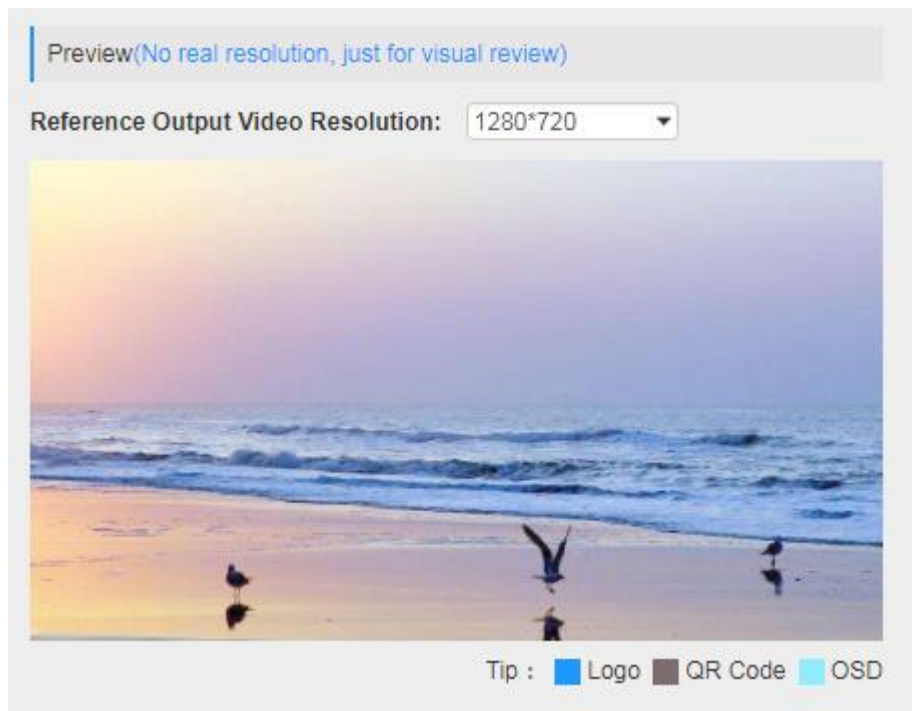

- **LOGO setting:** you can upload several pictures at the same time, and pick one to show on the screen. Click the box in the picture to choose it.

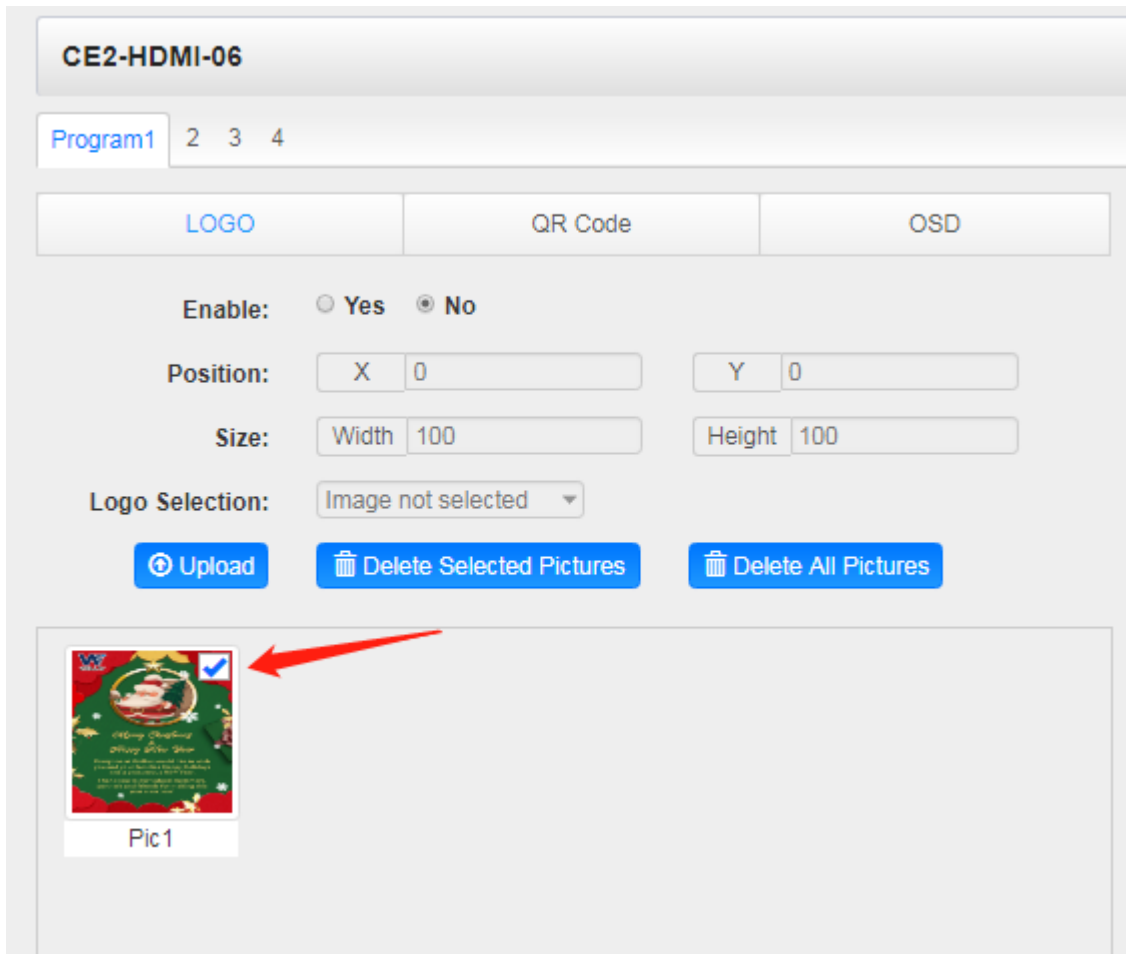

LOGO Parameter	Range	LOGO Parameter	Range
Position X	0~1920 (Dual)	Position Y	0~1080 (Dual)
Size width	2~1920 (Dual)	Size Height	2~1080 (Dual)

➤ **OSD setting:**

CE2-HDMI-06

Program1
2
3
4

LOGO

QR Code

OSD

Enable: **Yes** **No**

Position: X Y

Horizontal Pixel: [0-960]

Font Color: ▼

Font Size:

Subtitle:

Welcome to Encoder

[0~1024]

Subtitle Parameter	Range	LOGO Parameter	Range
Horizontal Pixel	10~1920	Scrolling Speed	1~20
Front Color	White/Black/Blue/Green/ Red/Yellow	Front Size	0~100

- **QR Code setting:** QR Code picture picking method is same as LOGO setting.

CE2-HDMI-06

Program1
2
3
4

LOGO

QR Code

OSD

Enable: Yes No

Position: X Y

Size: Width Height

QR Code Selection:

📁 Upload
🗑️ Delete Selected Pictures
🗑️ Delete All Pictures



Pic1

QR Code Parameter	Range	QR Code Parameter	Range
Position X	0~1920 (Dual)	Position Y	0~1080 (Dual)
Size width	0~1920 (Dual)	Size Height	0~1080 (Dual)

CE2-HDMI-06> System

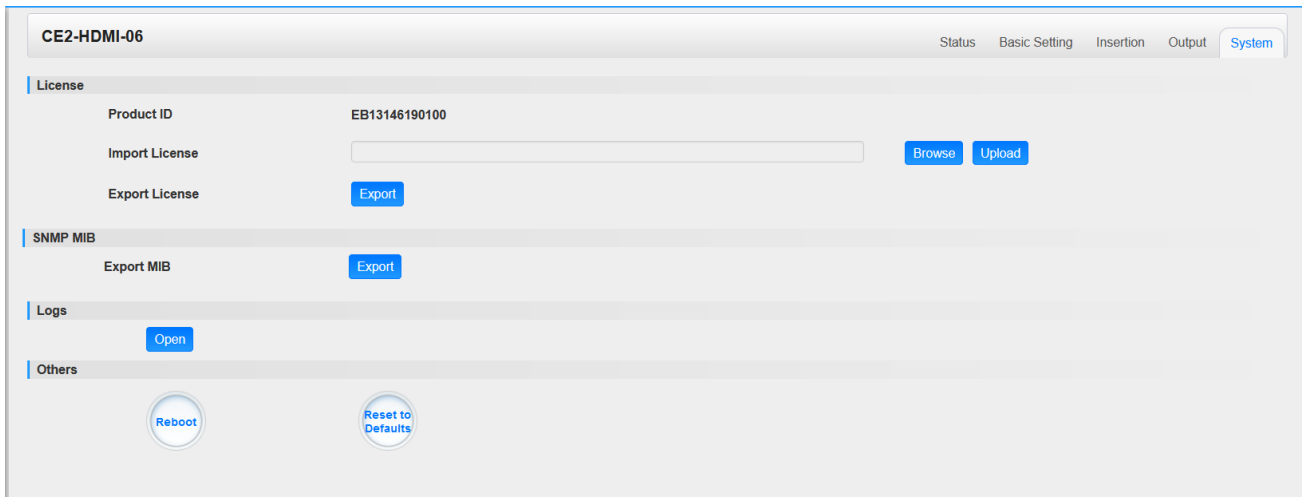

On the **System** page you can **Import/Export License**, **Reboot** module, **Reset to Defaults** and **Manage Logs**.

5.3 Modulation Output modules

5.3.1 CM2-QAMA-R00

➤ **CM2-QAMA-R00**

CM2-QAMA-R00 module supports modulating 16 non-adjacent or channels with 1 RF female port for modulating output and 1 RJ45 network port is reserved for future use. QAMA and B share the same Hardware but Different Software. If you need to change the Module from A to B, please contact your local support for assistance.



Module configuration is similar to IP Setting.

CM2-QAMA-00 >Basic Setting

This page is where you can modify or set the frequency for the RF modulation. CM2-QAMA-00 has 16 non-adjacent channels while CM2-QAMA-R01 has 4 adjacent channels both at single port.

Click the **Apply** button on the right side to make the change take effect.

Name	Range	Name	Range
Bandwidth	6M, 7M, 8M	RF level	0~63 (dB μ V)
			60~123 (dBmV)
Symbol Rate (KBaud)	4400~6956	Frequency (KHz)	48000~858000
		Constellation	QAM16/32/64/128/256

CM2-QAMA-00 >Output

QAM Output will be different from the Receiver and Encoder module. Since the QAM module is an output module like IP output, all services configured in receiver, encoder and IP input will be seen here.

- TS setting: Please refer to IP output service configuration.
- LCN setting: You need to add NIT streams of all frequencies in the base TS (frequency), which is used for your STB to automatically search and identify all the TS (frequencies) LCN information.
 - Check or reset Original Network ID and TS ID of each TS (frequency).Each TS should have different IDs.
 - Fill the Original Network ID and TS ID of each TS (frequency) in the field of the base TS (frequency) and then click **Add** to create a NIT stream for this TS (frequency).

- Click +**Descriptor** then LCN Descriptor to check all the programs which are contained in this frequency. Then set programs LCN.

NIT
TOT
[1.1]

Import
Export

Tag: 0x Network Name: Add

Tag	Data	Length	Operation
0x40	0	1	✕

NIT Stream

Original Network ID: TS ID: Add

ONID	TS ID	Descriptor	Operation
0	0		✕ +Descriptor

NIT Actual

Apply

Clear Config

Logical Channel Number Add

TS	Service ID	Service Name	LCN [0, 1023]	Visible Service Flag	<input type="checkbox"/>
1.1	32	Program3	<input type="text" value="1"/>	Visible ▼	<input type="checkbox"/>
1.2	32	Program3	<input type="text" value="2"/>	Visible ▼	<input type="checkbox"/>

Service List Add

TS	Service ID	Service Name	Service Type	
1.1	<input type="text" value="32"/>	Program3	Digital Radio Sound Ser x	<input type="checkbox"/>
1.2	<input type="text" value="32"/>	Program3	Digital Radio Sound Ser x	<input type="checkbox"/>

Satellite Delivery System

Frequency(MHz) [48000,858000]

Symbol Rate(Ksymbol/s) [0,999000]

Polarization

[Advanced Parameters](#) ▼

Terrestrial Delivery System

Centre Frequency [1, 4294967295](10Hz)

Bandwidth

[Advanced Parameters](#) ▼

- Click +**Descriptor** and add the **Cable Descriptor** in. Then fill in the correct frequency and symbol rate and choose the correct constellation of the TS (frequency).Then click **OK**. (this operation should be set on Modulator module only).

Cable Delivery System

Frequency(KHz) [48000,858000]

Symbol Rate(Ksymbol/s) [0,999000]

Modulation

FEC Outer

FEC Inner

OK
Close

- Do same operations to add next TS (frequency) until NIT streams of all the frequencies have been included. At last click Apply button to let all configuration take effect. Then searching programs in your STB, you will get all programs in order of LCN which you set.

CM2-QAMA-R00> System

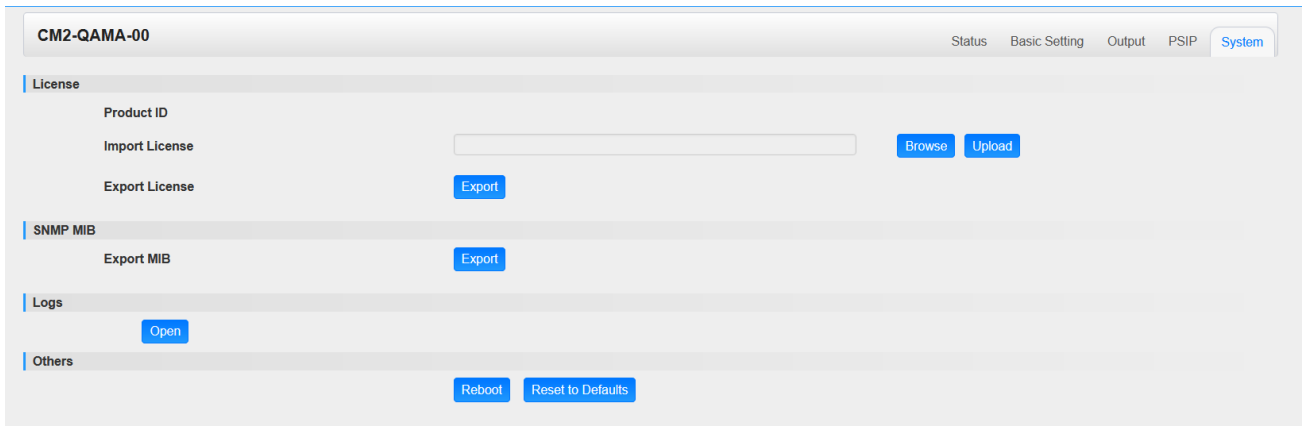

On the **System** page you can **Import/Export License**, **Reboot** module, **Reset to Defaults** and **Manage Logs**.

5.3.2 CM2-8VSB-03

CM2-8VSB-03 module supports up to 8 8VSB adjacent frequencies modulating with 1 RF connector for output.

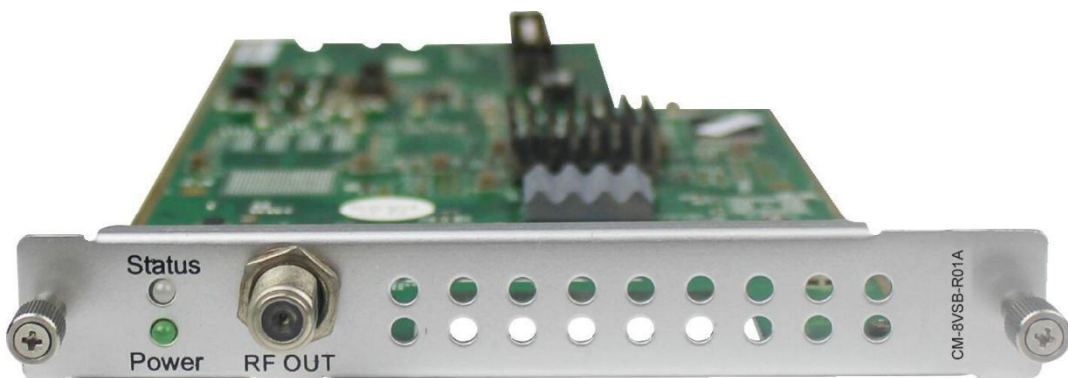

Module configuration is similar to IP Setting.

CM2-8VSB-03>Basic Setting

Click the **Apply** button on the right side to make the change take effect.

Name	Range	Name	Range
RF level (1=0.5dB)	15~48	PSI/SI Interval (ms)	50~10000
Channel Standard	OFF-AIR	Frequency (KHz)	CH2-57MHz
	STD		~
	IRC		CH69-802MHz
	SRC		

CM2-8VSB-03 >Output

- TS setting: Please refer to IP output service configuration.
- To use this board, you need to change the **Standard** to ATSC in **System Settings**.
- Don't forget to click **APPLY** when you finish configuration.

5.3.3 CM2-QAMB-R00

➤ **CM2-QAMB-R00**

CM2-QAMB-00 module supports up to 16 channels of non-adjacent frequency QAM-B modulating board.



Module configuration is similar to IP Setting.

CM2-QAMB-00 >Basic Setting

CM2-QAMB-00 Status **Basic Setting** Output PSIP System

RF Level: 45 (dBmV dBuV) PSI/SI Interval(ms): 100 Channel Standard: STD

Channel	Enable	QAM Mode	Channel No.	Bandwidth(MHz)	Constellation	SymbolRate(KBaud)
1.1	<input checked="" type="checkbox"/>	ANNEX B	CH23-219MHz	6	QAM256	5361
1.2	<input checked="" type="checkbox"/>	ANNEX B	CH24-225MHz	6	QAM256	5361
1.3	<input checked="" type="checkbox"/>	ANNEX B	CH25-231MHz	6	QAM256	5361
1.4	<input type="checkbox"/>	ANNEX B	CH5-79MHz	6	QAM256	5361
1.5	<input type="checkbox"/>	ANNEX B	CH6-85MHz	6	QAM256	5361
1.6	<input type="checkbox"/>	ANNEX B	CH7-177MHz	6	QAM256	5361
1.7	<input type="checkbox"/>	ANNEX B	CH8-183MHz	6	QAM256	5361
1.8	<input type="checkbox"/>	ANNEX B	CH9-189MHz	6	QAM256	5361
1.9	<input type="checkbox"/>	ANNEX B	CH10-195MHz	6	QAM256	5361
1.10	<input type="checkbox"/>	ANNEX B	CH11-201MHz	6	QAM256	5361
1.11	<input type="checkbox"/>	ANNEX B	CH12-207MHz	6	QAM256	5361
1.12	<input type="checkbox"/>	ANNEX B	CH13-213MHz	6	QAM256	5361
1.13	<input type="checkbox"/>	ANNEX B	CH14-123MHz	6	QAM256	5361
1.14	<input type="checkbox"/>	ANNEX B	CH15-129MHz	6	QAM256	5361
1.15	<input type="checkbox"/>	ANNEX B	CH16-135MHz	6	QAM256	5361
1.16	<input type="checkbox"/>	ANNEX B	CH17-141MHz	6	QAM256	5361

Name	Range	Name	Range
Channel Standard	STD, IRC, HRC, Customized	RF level (dBuV)	85~105
Bandwidth (MHz)	6	Constellation	QAM64/QAM256
Symbol Rate	5057(QAM64)		

Click the **Apply** button on the right side to make the change take effect.

CM2-QAMB-00>Service Configuration

- TS setting: Please refer to IP output service configuration.
- LCN setting: You need to add NIT streams of all frequencies to the base TS (frequency), which is for your STB to automatically search and identify all the TS (frequencies) LCN information.
 - Check or reset Original Network ID and TS ID of each TS (frequency)., Each TS should have different IDs.
 - Fill the Original Network ID and TS ID of each TS (frequency) in the field of the base TS (frequency) and then click **Add** to create a NIT stream for this TS (frequency).
 - Click **+Descriptor** then **LCN Descriptor** to check all the programs which are contained in this frequency. Then set programs LCN.

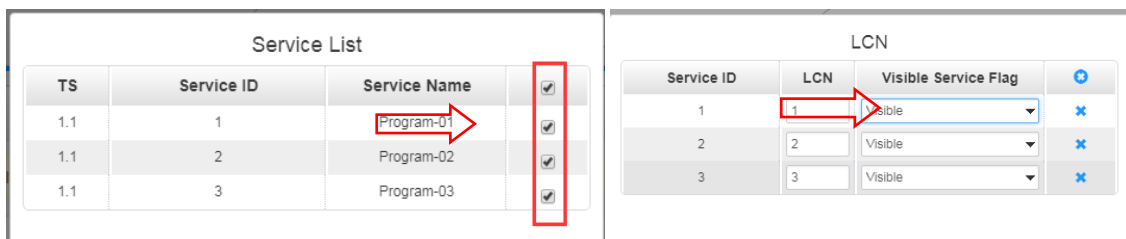
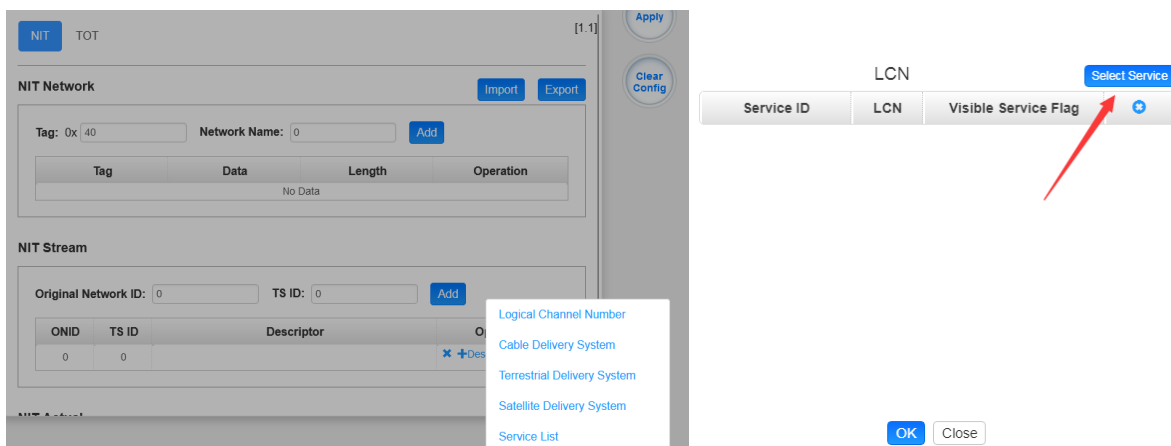

- Click **+Descriptor** and **the Cable Descriptor**. Then fill in the correct frequency and symbol rate and choose the correct constellation of the TS (frequency).Then click **OK**. (This operation should be set on Modulator module only).
- You can also add **Cable Delivery System, Terrestrial Delivery System, Satellite Delivery system, and Service List**.

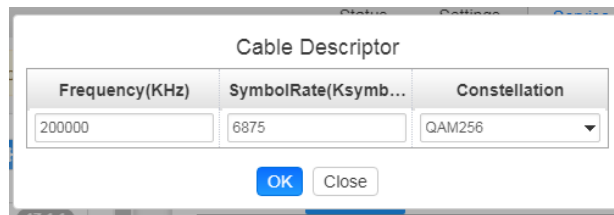

- Repeat the operations to add next TS (frequency) until NIT streams of all the frequencies have been included. Finally click **Apply** button to let all configuration take effect. Then searching programs in your STB, you will get all programs in the order of LCN which you set.

5.3.4 CM2-DTMB-03

➤ **CM2-DTMB-03**

CM2-DTMB-03 module supports up to 8 channels of adjacent frequency DTMB modulating board



Module configuration is similar to IP Setting.

CM2-DTMB-03 >Basic Setting

CM2-DTMB-03
Status **Basic Setting** Output System

Batch Setting ▾

RF Level(dBuV): 45 (dBmV dBuV)
PSI/SI Interval(ms): 100

Channel	Enable	Frequency(KHz)	Constellation Mode	Frame Head Mode	Carrier Mode	RF Level Gain (dB)
1.1	<input checked="" type="checkbox"/>	474000	4QAM LDPC 0.4	420 Variable	Single-Carrier	0
1.2	<input type="checkbox"/>	482000	4QAM LDPC 0.4	420 Variable	Single-Carrier	0
1.3	<input type="checkbox"/>	490000	4QAM LDPC 0.4	420 Variable	Single-Carrier	0
1.4	<input type="checkbox"/>	498000	4QAM LDPC 0.4	420 Variable	Single-Carrier	0
1.5	<input type="checkbox"/>	578000	4QAM LDPC 0.4	420 Variable	Single-Carrier	0
1.6	<input type="checkbox"/>	586000	4QAM LDPC 0.4	420 Variable	Single-Carrier	0
1.7	<input type="checkbox"/>	594000	4QAM LDPC 0.4	420 Variable	Single-Carrier	0
1.8	<input type="checkbox"/>	602000	4QAM LDPC 0.4	420 Variable	Single-Carrier	0

Apply

Name	Range	Name	Range
Frequency	48000~862000	RF level Gain(dB)	-10~0
Constellation Mode	4QAM LDPC0.4/0.6/0.8	Carrier Mode	Single Carrier
	16QAM LDPC 0.4/0.6/0.8	RF Level (dBuV)	25~60
	32QAm LDPC 0.8	PSI/SI Interval	50~10000
	64QAM LDPC 0.4/0.6/0.8		
Frame Head Mode	420 Variable		
	595 Fixed		

Click the **Apply** button on the right side to make the change take effect.

CM2-DTMB-03>Service Configuration

- TS setting: Please refer to IP output service configuration.
- LCN setting: You need to add NIT streams of all frequencies to the base TS (frequency), which is for your STB to automatically search and identify all the TS (frequencies) LCN information.
 - Check or reset Original Network ID and TS ID of each TS (frequency)., Each TS should have different IDs.
 - Fill the Original Network ID and TS ID of each TS (frequency) in the field of the base TS (frequency) and then click **Add** to create a NIT stream for this TS (frequency).
 - Click **+Descriptor** then **LCN Descriptor** to check all the programs which are contained in this frequency. Then set programs LCN.

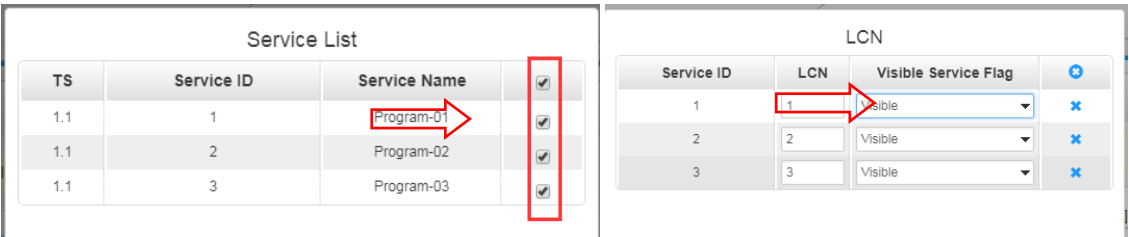
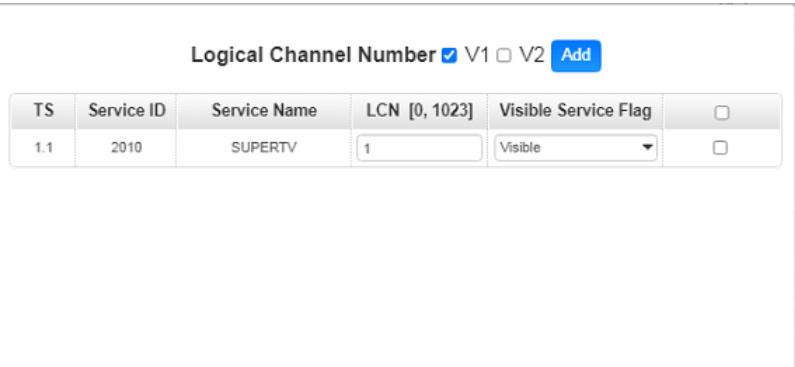
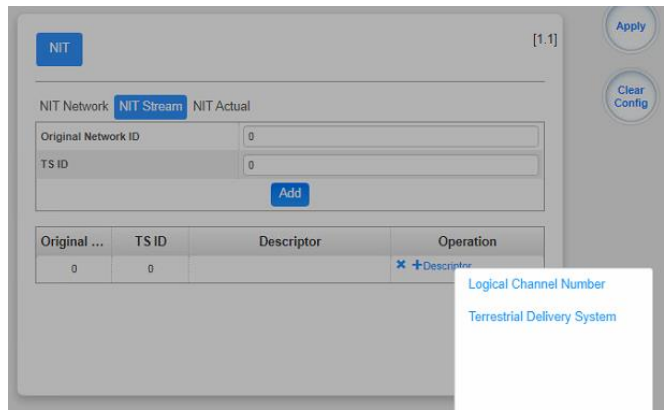

- Click **+Descriptor** and **the Cable Descriptor**. Then fill in the correct frequency and symbol rate and choose the correct constellation of the TS (frequency).Then click **OK**. (This operation should be set on Modulator module only).
- You can also add **Terrestrial Delivery System**

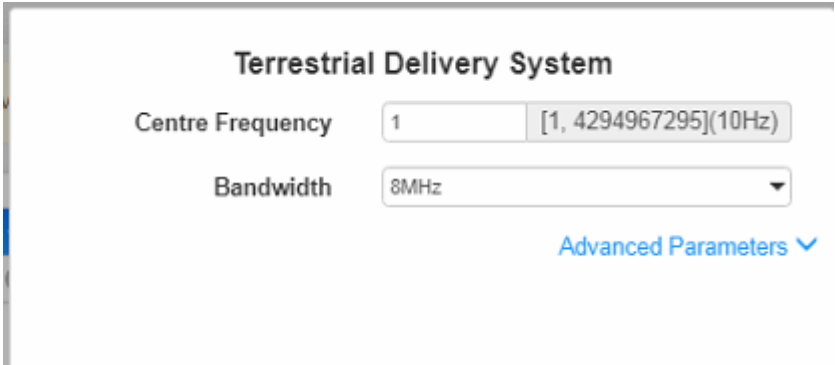

- Repeat the operations to add next TS (frequency) until NIT streams of all the frequencies have been included. Finally click **Apply** button to let all configuration take effect. Then searching programs in your STB, you will get all programs in the order of LCN which you set.

CM2-DTMB-03> System

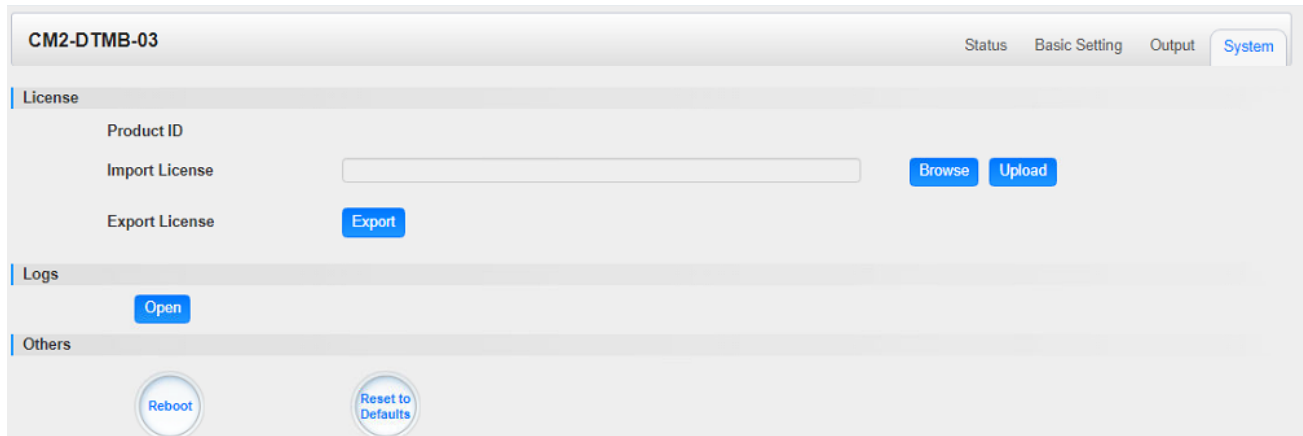

On the **System** page you can **Import/Export License**, **Reboot** module, **Reset to Defaults** and **Manage Logs**.

5.3.5 CM2-QAMA-03

CM2-QAMA-03 module supports up to 8 channels of adjacent frequency QAM-A/C modulating board.



Module configuration is similar to IP Setting.

CM2-QAMA-03>Basic Setting

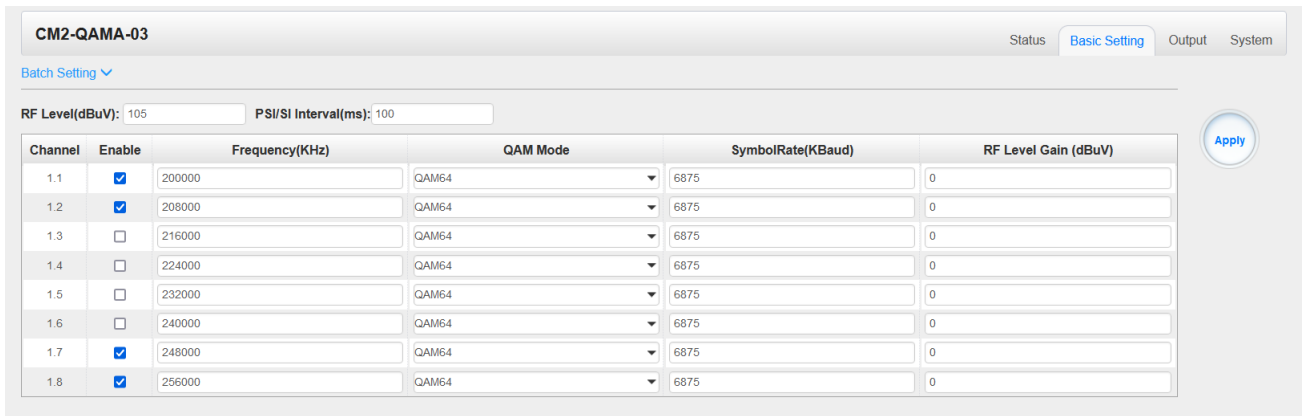

Click the **Apply** button on the right side to make the change take effect.

Name	Range	Name	Range
Symbol Rate	3600~3956	RF level gain	-10`~0 (multiples of 0.5)
Frequency (KHz)	48000~862000	QAM Mode	QAM16/QAM32/QAM64/QAM128/QAM256

CM2-QAMA-03>Output

- TS setting: Please refer to IP output configuration.
- LCN setting: You need to add NIT stream of all frequencies in the base TS (frequency) which is used for your STB auto search and identifies all the TS (frequencies) LCN information.
 - Check or reset Original Network ID and TS ID of each TS (frequency). Each TS should have different IDs.
 - Fill the Original Network ID and TS ID of each TS (frequency) in the field of the base TS (frequency) and then click **Add** to create a NIT stream for this TS (frequency).
 - Click **+Descriptor** and **Cable Descriptor**. Then fill in the correct frequency and symbol rate and choose the correct constellation of the TS (frequency) and then click **OK** (this operation should be set on Modulator module only).

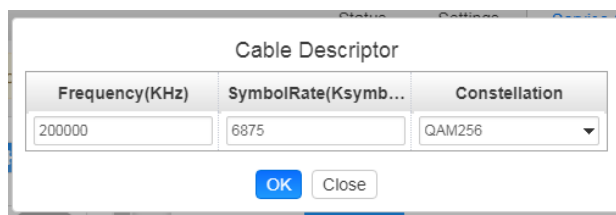

- Click **+Descriptor** and add the **LCN Descriptor** to check all the programs which are contained in this frequency. Then set programs LCN.

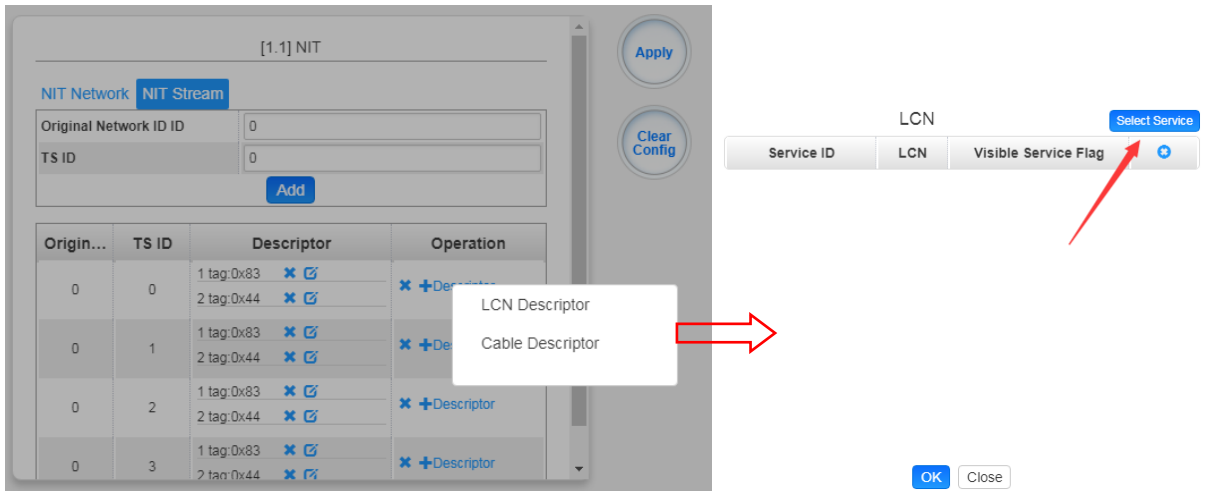

- Repeat the operations to add next TS (frequency) until NIT streams of all the frequencies have been included. Finally click Apply button to let all configuration take effect. Then searching programs in your STB, you will get all programs in the order of LCN which you set.

5.3.6 CM2-OFDM-03

CM2-OFDM-03 module supports up to 8 channels of adjacent frequency OFDM modulating board.



Module configuration is similar to IP Setting.

CM2-OFDM-03>Basic Setting

The screenshot shows the 'CM2-OFDM-03' configuration window. At the top, there are tabs for 'Status', 'Basic Setting' (selected), 'Output', and 'System'. Below the tabs, there are input fields for 'RF Level: 105 (dBuV)' and 'PSI/SI Interval(ms): 100'. The main area contains a table with the following columns: Channel, Enable, Frequency(KHz), Bandwidth(MHz), FFT Mode, GI Mode, QAM Mode, Convolutional Coding, and RF Level Gain (dBuV). The table has 8 rows, numbered 1.1 to 1.8. The 'Enable' column has checkboxes, with 1.1, 1.2, 1.7, and 1.8 checked. The 'Apply' button is located on the right side of the table.

Channel	Enable	Frequency(KHz)	Bandwidth(MHz)	FFT Mode	GI Mode	QAM Mode	Convolutional Coding	RF Level Gain (dBuV)
1.1	<input checked="" type="checkbox"/>	200000	6	2K	1/4	64QAM	1/2	0
1.2	<input checked="" type="checkbox"/>	208000	6	2K	1/4	64QAM	1/2	0
1.3	<input type="checkbox"/>	216000	6	2K	1/4	64QAM	1/2	0
1.4	<input type="checkbox"/>	224000	6	2K	1/4	64QAM	1/2	0
1.5	<input type="checkbox"/>	232000	6	2K	1/4	64QAM	1/2	0
1.6	<input type="checkbox"/>	240000	6	2K	1/4	64QAM	1/2	0
1.7	<input checked="" type="checkbox"/>	248000	6	2K	1/4	64QAM	1/2	0
1.8	<input checked="" type="checkbox"/>	256000	6	2K	1/4	64QAM	1/2	0

Click the **Apply** button on the right side to make the change take effect.

Name	Range	Name	Range
Bandwidth	6M, 7M, 8M	RF level (dbuV)	85~120
Frequency (KHz)	48000~862000	FFT Mode	2k
GI Mode	¼, 1/8, 1/16, 1/32	QAM Mode	QPSK/16QAM/64QAM
Convolutional Coding	½, 2/3, 3/4, 5/6, 7/8		

CM2-OFDM-03>Output

- TS setting: Please refer to IP output configuration.
- LCN setting: You need to add NIT stream of all frequencies in the base TS (frequency) which is used for your STB auto search and identifies all the TS (frequencies) LCN information.
 - Check or reset Original Network ID and TS ID of each TS (frequency). Each TS should have different IDs.
 - Fill the Original Network ID and TS ID of each TS (frequency) in the field of the base TS (frequency) and then click **Add** to create a NIT stream for this TS (frequency).
 - Click **+Descriptor** and **Cable Descriptor**. Then fill in the correct frequency and symbol rate and choose the correct constellation of the TS (frequency) and then click **OK** (this operation should be set on Modulator module only).

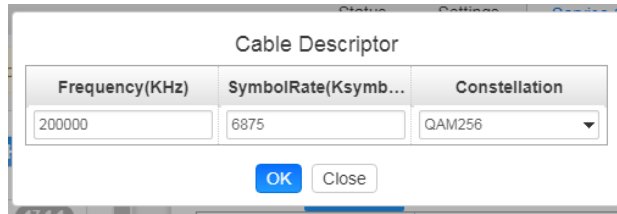

- Click **+Descriptor** and add the **LCN Descriptor** to check all the programs which are contained in this frequency. Then set programs LCN.

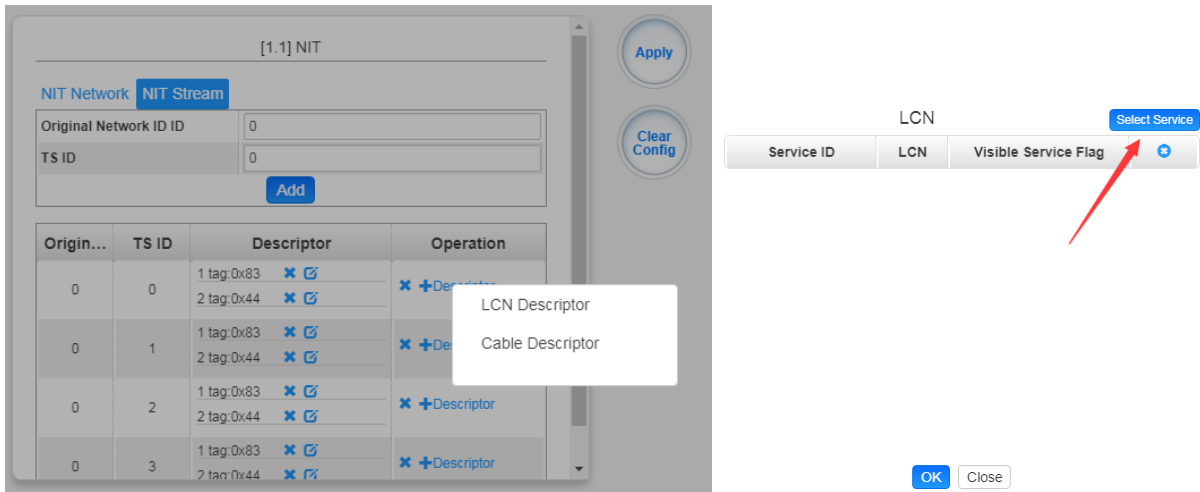

Service List

TS	Service ID	Service Name	<input type="checkbox"/>
1.1	1	2.5M-CCTV1	<input checked="" type="checkbox"/>
1.2	1	Program0	<input type="checkbox"/>
1.3	1	LipSync_1080i	<input type="checkbox"/>
1.3	2	td HD Phx Chinese Cha...	<input type="checkbox"/>

Logical Channel Number V1 V2

TS	Service ID	Service Name	LCN [0, 1023]	Visible Service Flag	<input type="checkbox"/>
1.1	36	GOLDEN	1	Visible	<input type="checkbox"/>
1.1	37	D PELICULA	2	Visible	<input type="checkbox"/>
1.1	38	TLNOVELAS	3	Visible	<input type="checkbox"/>
1.2	39	UNIVISION	4	Visible	<input type="checkbox"/>

- Repeat the operations to add next TS (frequency) until NIT streams of all the frequencies have been included. Finally click Apply button to let all configuration take effect. Then searching programs in your STB, you will get all programs in the order of LCN which you set.

5.3.7 CM2-ISDBT-03

CM2-ISDBT-03 module supports up to 8 channels of adjacent frequency ISDBT-T modulating board



CM2-ISDBT-03>Basic Setting

CM2-ISDBT-03

Status Basic Setting Output System

Temperature: 33°C (91.4°F) Tip: The module will automatically power off when the temperature reaches or exceeds 74 degrees Celsius(165.2 degrees Fahrenheit)

Channel	Effective Bitrate(Mbps)	Total Bitrate(Mbps)	Bitrate	TS Analysis	Service List
1.1	0.000	0.000	Normal	👁	☰
1.2	0.000	0.000	Normal	👁	☰
1.3	0.000	0.000	Normal	👁	☰
1.4	0.000	0.000	Normal	👁	☰
1.5	0.000	0.000	Normal	👁	☰
1.6	0.000	0.000	Normal	👁	☰
1.7	0.000	0.000	Normal	👁	☰
1.8	0.000	0.000	Normal	👁	☰

Click the **Apply** button on the right side to make the change take effect.

Name	Range	Name	Range
Bandwidth(MHZ)	6M	RF level	25~45dBmV/85~105dB μ V
Frequency (KHz)	48000~862000	FFT Mode	2K
GI Mode	1/4, 1/8, 1/16, 1/32	RF Level Gain(dB)	45~55
QAM Mode	QPSK	Convolutional	1/2, 2/3, 3/4, 5/6, 7/8
	16QAM	Coding	
	64QAM		

CM2-ISDBT-03>Output

- TS setting: Please refer to IP output service configuration.
- LCN setting: You need to add NIT streams of all frequencies to the base TS (frequency) which is for your STB to automatically search and identify all the TS (frequencies) LCN information.
 - Check or reset Original Network ID and TS ID of each TS (frequency). Each TS should have different IDs.
 - Fill the Original Network ID and TS ID of each TS (frequency) in the field of the base TS (frequency) and then click **Add** to create a NIT stream for this TS (frequency).
 - Click **+Descriptor** and **Cable Descriptor**. Fill in the correct frequency and symbol rate and choose the correct constellation of the TS (frequency) and then click OK (this operation should be set on Modulator module only).

Cable Descriptor

Frequency(KHz)	Constellation
474000	64QAM

- Click **+Descriptor** and **LCN Descriptor** to check all the programs which are contained in this frequency. Then set programs LCN.

The left screenshot shows the NIT configuration interface. It includes fields for 'Original Network ID' and 'TS ID', both set to 0, and an 'Add' button. Below is a table with columns: Original Ne..., TS ID, Descriptor, and Operation. A '+Descriptor' button is visible next to the table.

The right screenshot shows the LCN configuration interface. It features a table with columns: Service ID, LCN, and Visible Service Flag. A 'Select Service' button is located to the right of the table. A red arrow points from the 'Select Service' button to the 'Service List' option in the dropdown menu.

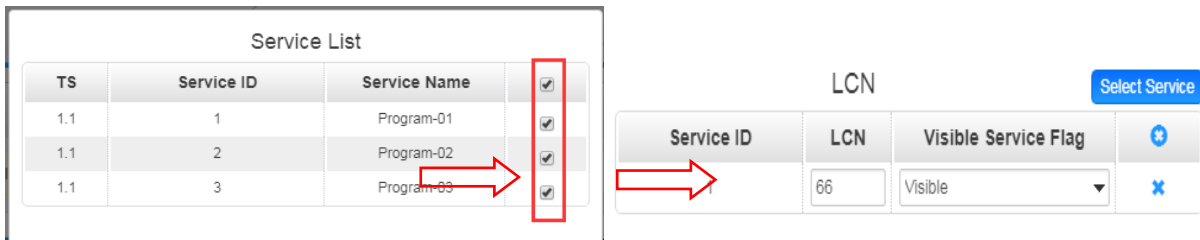

- Repeat the operations to add next TS (frequency) until NIT streams of all the frequencies have been included. Finally click Apply button to let all configuration take effect. Then searching programs in your STB, you will get all programs in the order of LCN you set.

5.3.8 CM2-QAMB-02

5.3.8 CM2-QAMB-02

CM2-QAMB-02 is a 16/32-channel QAM-B modulation output module with 2 gigabit IP input ports (single port supports 256-channel input), 1 CAS interface (RJ45) supporting scrambling (It is not enabled by default and requires additional authorization) and 1 RF output interface supporting up to 32 QAM-B non-adjacent frequencies modulating with independent constellation mode configuration.

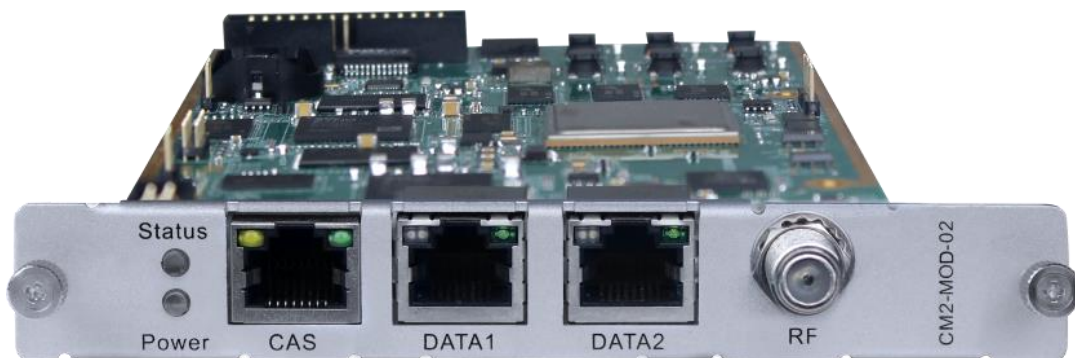

CM2-QAMB-02 > Status

The Status page contains status information of IP Input, Modulation Output and IP Output.

IP Input >CM2-MOD-02 has 1024 IP input channels. Those channels are divided into two RJ45 ports, each port has 512 IP input channels. Click Port 1tab, users can obtain the 256channels status information such as input source IP address and port number, total bitrate (Mbps) and effective bitrate (Mbps). The TS analysis and Service List button on each channel allow users to check the detailed information in each TS. See the image below for reference.

The screenshot shows the 'Input' status page for CM2-MOD-02. The total bitrate is 0.000 Mbps. A table lists 11 channels (1.1 to 1.11) with the following data:

Channel	IP Address: Port	Status	Effective Bitrate(Mbps)	Total Bitrate(Mbps)	TS Analysis	Service List
1.1	0.0.0.0	●	0.000	0.000	👁	☰
1.2	0.0.0.0	●	0.000	0.000	👁	☰
1.3	0.0.0.0	●	0.000	0.000	👁	☰
1.4	0.0.0.0	●	0.000	0.000	👁	☰
1.5	0.0.0.0	●	0.000	0.000	👁	☰
1.6	0.0.0.0	●	0.000	0.000	👁	☰
1.7	0.0.0.0	●	0.000	0.000	👁	☰
1.8	0.0.0.0	●	0.000	0.000	👁	☰
1.9	0.0.0.0	●	0.000	0.000	👁	☰
1.10	0.0.0.0	●	0.000	0.000	👁	☰
1.11	0.0.0.0	●	0.000	0.000	👁	☰

This screenshot is identical to the one above, but with a red rectangular box highlighting the 'Channel' column of the table.

Channel	IP Address: Port	Status	Effective Bitrate(Mbps)	Total Bitrate(Mbps)	TS Analysis	Service List
1.1	0.0.0.0	●	0.000	0.000	👁	☰
1.2	0.0.0.0	●	0.000	0.000	👁	☰
1.3	0.0.0.0	●	0.000	0.000	👁	☰
1.4	0.0.0.0	●	0.000	0.000	👁	☰
1.5	0.0.0.0	●	0.000	0.000	👁	☰
1.6	0.0.0.0	●	0.000	0.000	👁	☰
1.7	0.0.0.0	●	0.000	0.000	👁	☰
1.8	0.0.0.0	●	0.000	0.000	👁	☰
1.9	0.0.0.0	●	0.000	0.000	👁	☰
1.10	0.0.0.0	●	0.000	0.000	👁	☰
1.11	0.0.0.0	●	0.000	0.000	👁	☰

Click the eye icon , users can know all the PIDs such as PAT, CAT, PCR2, Video Audio, PCR2 PID etc in this TS. See the image below for reference.

Input Status IP Setting IGMP Setting Service Configuration

Total Bitrate: 0.000 Mbps

Channel	IP Address: Port	Status	Effective Bitrate(Mbps)	Total Bitrate(Mbps)	TS Analysis	Service List
1.1	0.0.0.0	●	0.000	0.000	👁️	☰
1.2	0.0.0.0	●	0.000	0.000	👁️	☰
1.3	0.0.0.0	●	0.000	0.000	👁️	☰
1.4	0.0.0.0	●	0.000	0.000	👁️	☰
1.5	0.0.0.0	●	0.000	0.000	👁️	☰
1.6	0.0.0.0	●	0.000	0.000	👁️	☰
1.7	0.0.0.0	●	0.000	0.000	👁️	☰
1.8	0.0.0.0	●	0.000	0.000	👁️	☰
1.9	0.0.0.0	●	0.000	0.000	👁️	☰
1.10	0.0.0.0	●	0.000	0.000	👁️	☰
1.11	0.0.0.0	●	0.000	0.000	👁️	☰

Channel 1.1 TS Analysis Reset Counter

Search

PID	Bitrate(Mbps)	Bandwidth(%)	Continuity Count Error	Type	Service
No Data					

If the input stream has multiple programs, users can click the icon below “Service List” to see all the services in this stream. See the image below for reference.

Channel	IP Address : Port	Effective Bitrate(Mbps)	Total Bitrate(Mbps)	TS Analysis	Service List
1.1	227.40.50.88 : 1234	18.455	19.764	👁️	☰
1.2	227.40.50.89 : 1234	18.446	19.750	👁️	☰
1.3	227.40.50.90 : 1234	18.446	19.750	👁️	☰
1.4	227.40.50.91 : 1234	9.521	10.064	👁️	☰
1.5	227.40.50.92 : 1234	19.179	20.129	👁️	☰
1.6	0.0.0.0	0.000	0.000	👁️	☰
1.7	0.0.0.0	0.000	0.000	👁️	☰
1.8	0.0.0.0	0.000	0.000	👁️	☰
1.9	0.0.0.0	0.000	0.000	👁️	☰

Channel : 1.1

#	Service
1	[3]
2	[4]
3	[5]

You can also check the details of a service by clicking the Service Name.

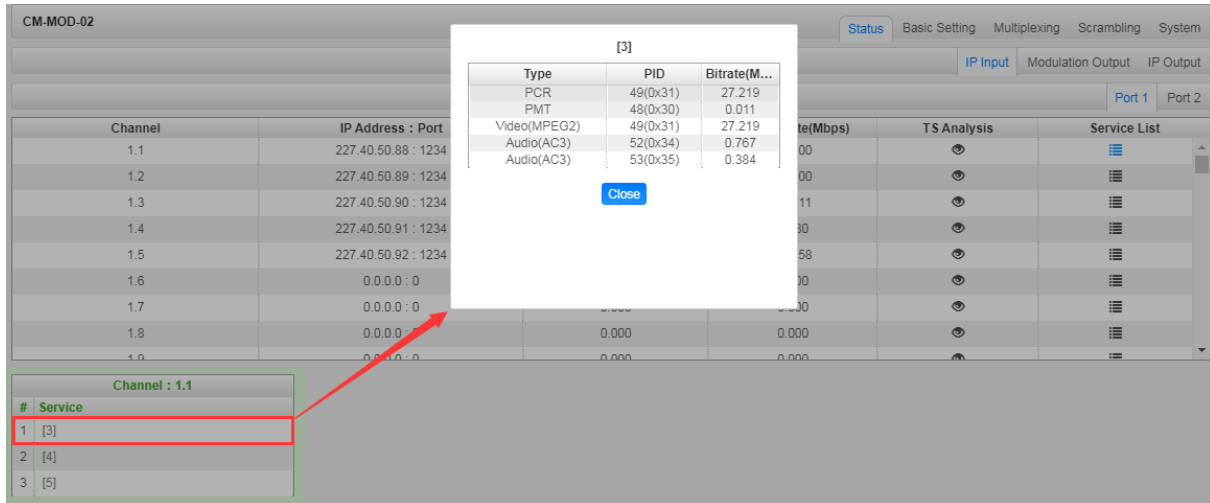

Modulation Output>CM2-QAMB-02 status shows the Modulation output. Just like the IP Input, this shows the total bitrate and effective bitrate of the 32 channels respectively. The TS Analysis and Service List have the same function as in the IP input. The Status also shows the current temperature of the unit on the upper left corner. See image below for reference.

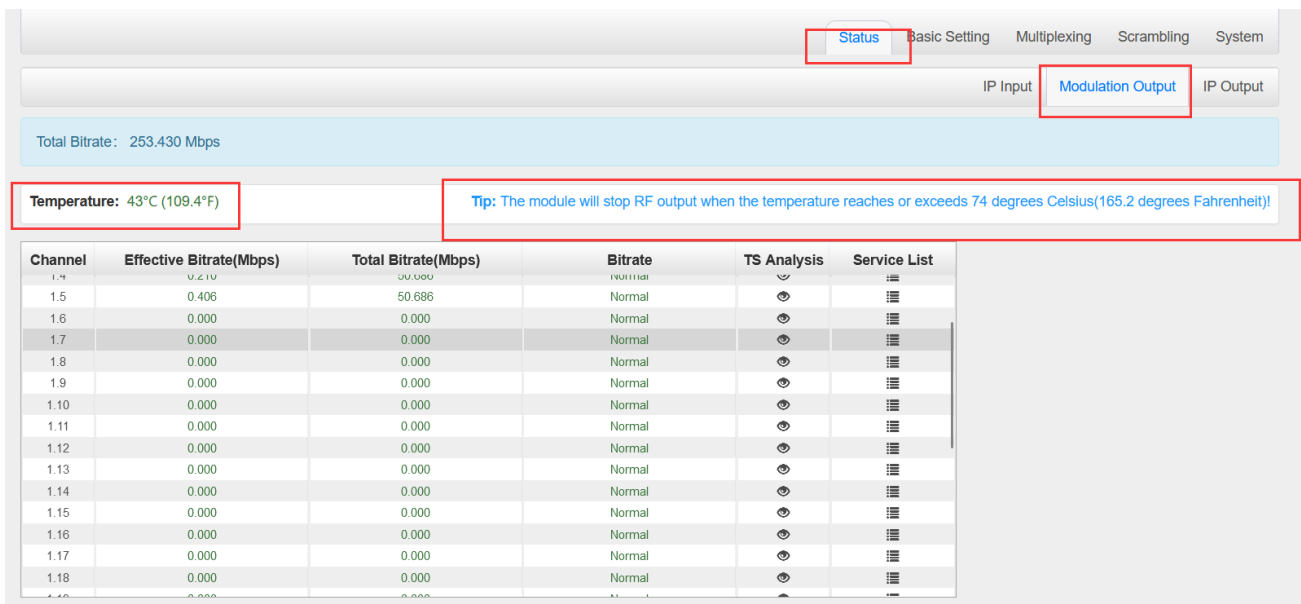

Channel	Effective Bitrate(Mbps)	Total Bitrate(Mbps)	Bitrate	TS Analysis	Service List
1.19	0.000	0.000	Normal	👁	☰
1.20	0.000	0.000	Normal	👁	☰
1.21	0.000	0.000	Normal	👁	☰
1.22	0.000	0.000	Normal	👁	☰
1.23	0.000	0.000	Normal	👁	☰
1.24	0.000	0.000	Normal	👁	☰
1.25	0.000	0.000	Normal	👁	☰
1.26	0.000	0.000	Normal	👁	☰
1.27	0.000	0.000	Normal	👁	☰
1.28	0.000	0.000	Normal	👁	☰
1.29	0.000	0.000	Normal	👁	☰
1.30	0.000	0.000	Normal	👁	☰
1.31	0.000	0.000	Normal	👁	☰
1.32	0.000	0.000	Normal	👁	☰

PID	Bitrate(Mbps)	Bandwidth(%)	Continuity Count Error	Type	Service
0x0(0)	0.015	0.039	84	PAT	
0x11(17)	0.015	0.039	37	SDT, BAT	
0x30(48)	0.015	0.039	99	PMT	
0x31(49)	0.000	0.000	127	PCR, Video	
0x34(52)	0.000	0.000	127	Audio	
0x35(53)	0.000	0.000	57	Audio	

IP Output→CM2-QAM-02 status also shows the IP output. Just like the IP Input, this shows the total bitrate and effective bitrate of the 16 channels respectively. The TS Analysis and Service List have the same function as in the IP input. See image below for reference.

Total Bitrate: 304.172 Mbps

Channel	IP Address: Port	Effective Bitrate(Mb...	Total Bitrate(Mb...	Bitrate	TS Analysis	Service List
1.1	224.20.20.1 : 1234	0.135	50.692	Normal	👁	☰
1.2	224.20.20.2 : 1234	0.180	50.702	Normal	👁	☰
1.3	224.20.20.3 : 1234	0.123	50.692	Normal	👁	☰
1.4	224.20.20.4 : 1234	0.213	50.692	Normal	👁	☰
1.5	224.20.20.5 : 1234	0.406	50.702	Normal	👁	☰
1.6	224.20.20.6 : 1234	0.000	50.692	Normal	👁	☰
1.7	0.0.0.0	0.000	0.000	Normal	👁	☰
1.8	0.0.0.0	0.000	0.000	Normal	👁	☰
1.9	0.0.0.0	0.000	0.000	Normal	👁	☰
1.10	0.0.0.0	0.000	0.000	Normal	👁	☰
1.11	0.0.0.0	0.000	0.000	Normal	👁	☰
1.12	0.0.0.0	0.000	0.000	Normal	👁	☰
1.13	0.0.0.0	0.000	0.000	Normal	👁	☰
1.14	0.0.0.0	0.000	0.000	Normal	👁	☰
1.15	0.0.0.0	0.000	0.000	Normal	👁	☰

Channel	IP Address: Port	Effective Bitrate(Mb...	Total Bitrate(Mb...	Bitrate	TS Analysis	Service List
1.1	224.20.20.1 : 1234	0.135	50.692	Normal	👁	☰
1.2	224.20.20.2 : 1234	0.180	50.702	Normal	👁	☰
1.3	224.20.20.3 : 1234	0.120	50.698	Normal	👁	☰
1.4	224.20.20.4 : 1234	0.210	50.692	Normal	👁	☰
1.5	224.20.20.5 : 1234	0.406	50.702	Normal	👁	☰
1.6	224.20.20.6 : 1234	0.000	50.692	Normal	👁	☰
1.7	0.0.0.0	0.000	0.000	Normal	👁	☰
1.8	0.0.0.0	0.000	0.000	Normal	👁	☰
1.9	0.0.0.0	0.000	0.000	Normal	👁	☰
1.10	0.0.0.0	0.000	0.000	Normal	👁	☰
1.11	0.0.0.0	0.000	0.000	Normal	👁	☰
1.12	0.0.0.0	0.000	0.000	Normal	👁	☰
1.13	0.0.0.0	0.000	0.000	Normal	👁	☰
1.14	0.0.0.0	0.000	0.000	Normal	👁	☰
1.15	0.0.0.0	0.000	0.000	Normal	👁	☰

CM2-QAMB-02 > Basic Setting

CM2-QAMB-02 Basic Setting is where users input the parameters for IP Input, Modulation Output and IP Output.

IP Input-Parameter Setting > On this page, there are three tabs where you can modify the multicast IP, port and parameter of IP Input. There are **Port 1**, **Port 2**, and **Batch Setting**. The input can accept Multicast or Unicast and support MPTS and SPTS.

Port 1 and Port 2 have same interface. It shows the 512 channels. Check the box under **Enable** to enable a channel. Input the correct Multicast/Unicast IP address and IP port, and select the correct Protocol for the source IP. Once done, click **Apply** for the changes to take effect. See the image below for reference.

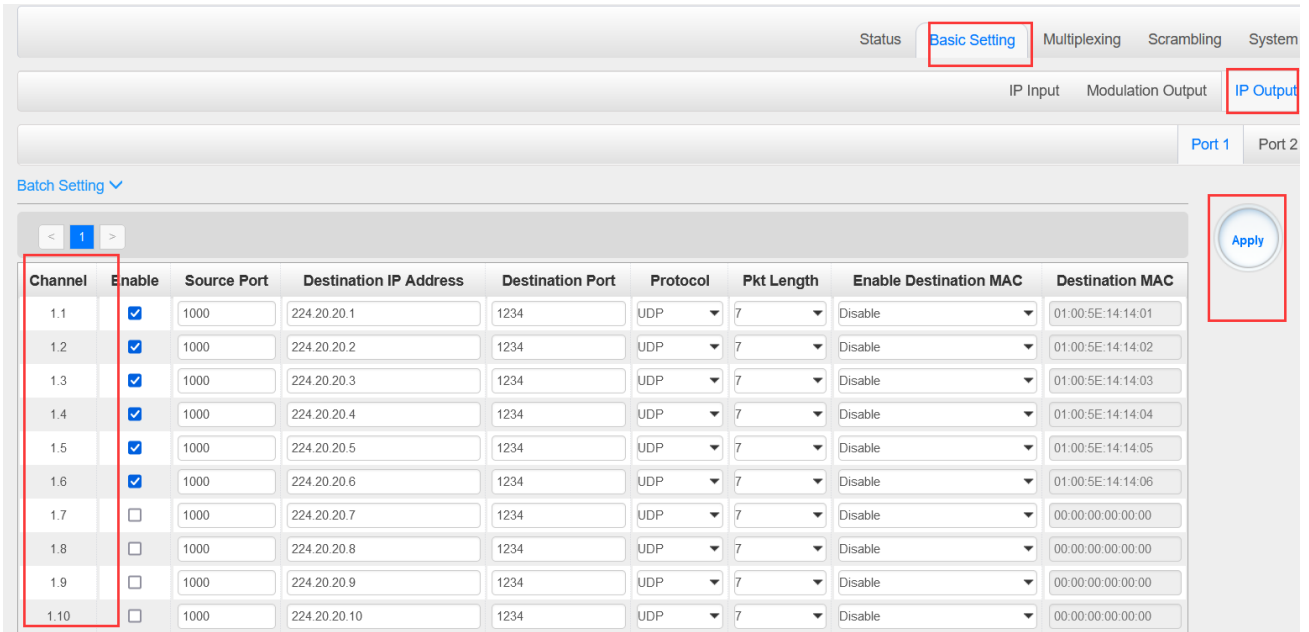

Basic Setting is where users can input the IP input parameters in batch. See the image below for reference.

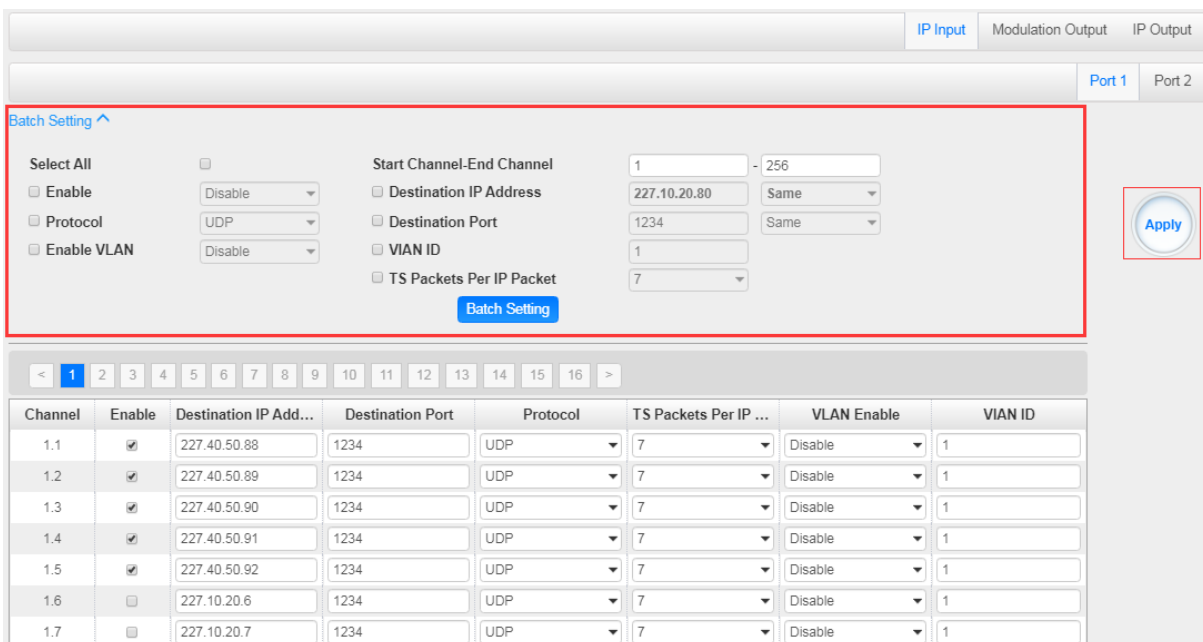

Modulation Output-Parameter Setting On this page, you can enable channels as you need and input the Frequency (KHz), QAM Mode, Symbol Rate (KBaud) and RF Level Gain (dBmV) to have an output.

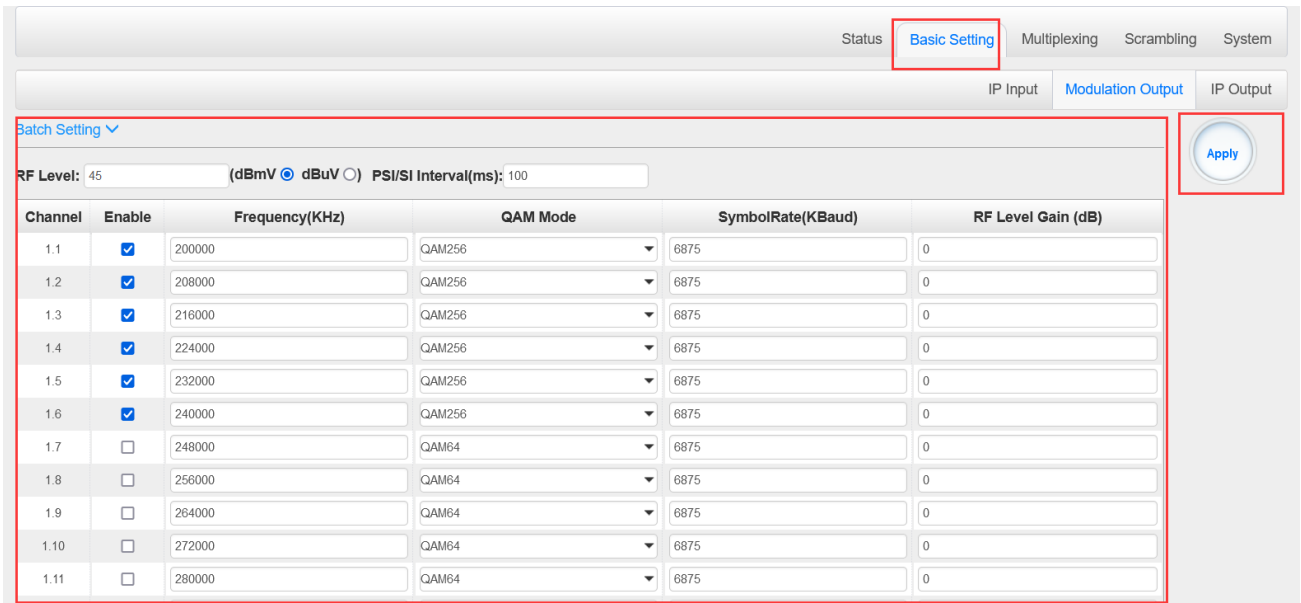

Here is the range parameter of the above info.

Name	Range
Channel Standard	STD, IRC, HRC, Customized
Bandwidth (MHz)	6
Symbol Rate	5057(QAM64) 5361(QAM256)

You can also set the RF level in a range of 85 to 120 as shown in the image below.

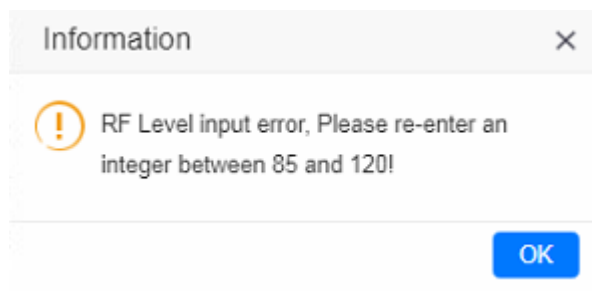

Batch Setting is where you can input the modulation parameters in batch. See the image below for reference.

The screenshot shows the 'Modulation Output' tab with the 'Batch Setting' section highlighted. The 'Batch Setting' section includes the following controls:

- Select All:**
- Enable:** Disable
- Bandwidth:** 7
- SymbolRate:** 6875
- Start Channel-End Channel:** 1 - 32
- Start Frequency:** 48000
- QAM Mode:** QAM32

Below the 'Batch Setting' section, there are two input fields: RF Level(dBmV): 105 and PSI/SI Interval(ms): 100. A blue 'Batch Setting' button is located below the 'Batch Setting' section. An 'Apply' button is located to the right of the 'Batch Setting' section.

Channel	Enable	Frequency(KHz)	QAM Mode	SymbolRate(KBaud)	RF Level Gain (dBmV)
1.1	<input checked="" type="checkbox"/>	474000	QAM64	6875	0
1.2	<input checked="" type="checkbox"/>	208000	QAM64	6875	0
1.3	<input checked="" type="checkbox"/>	216000	QAM64	6875	0
1.4	<input checked="" type="checkbox"/>	224000	QAM64	6875	0
1.5	<input checked="" type="checkbox"/>	490000	QAM64	6875	0
1.6	<input checked="" type="checkbox"/>	240000	QAM64	6875	0
1.7	<input type="checkbox"/>	248000	QAM64	6875	0

IP Output-IP Setting> On this page, there are three tabs where you can modify the multicast IP, port and parameter of IP Output. There are **Port 1**, **Port 2** and **Batch Setting**. The output can accept Multicast or Unicast and support MPTS and SPTS.

Port 1 shows the 16 channels. Check the box under Enable to enable a channel. Input the correct Multicast/Unicast IP address, IP port and appropriate output bitrate, and select the correct Protocol for the output IP. Once done, click **Apply** for the changes to take effect. See the image below for reference.

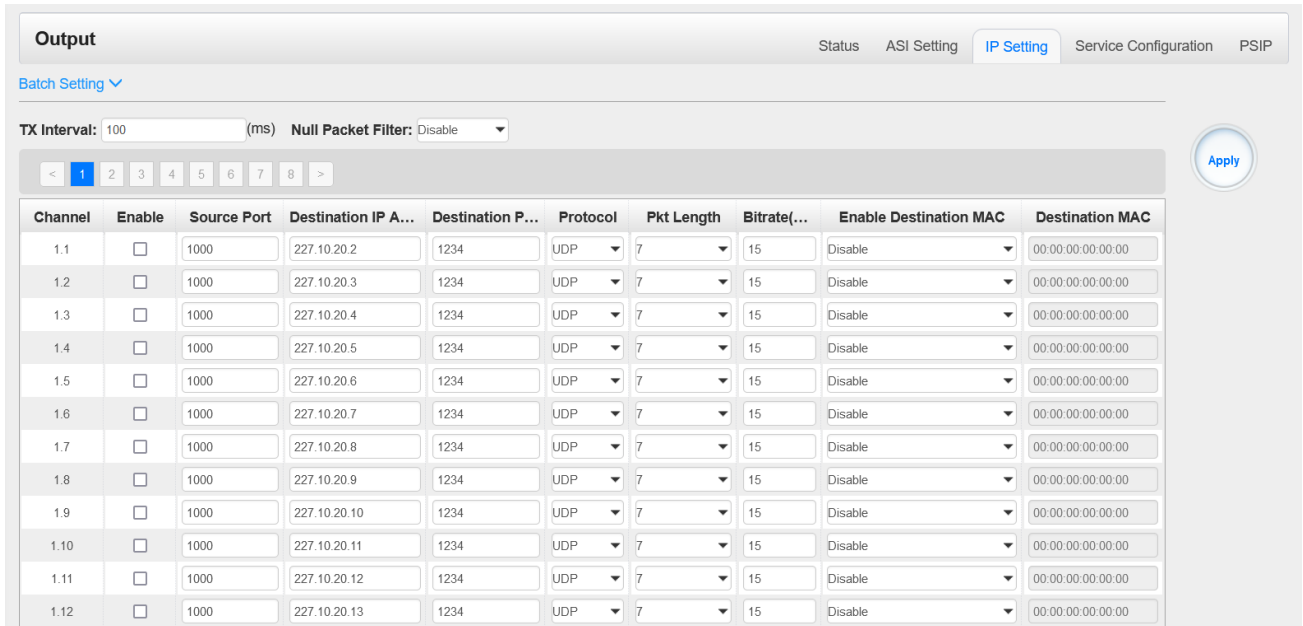

Batch Setting is where you can input the IP output parameters in batch. See the image below for reference.

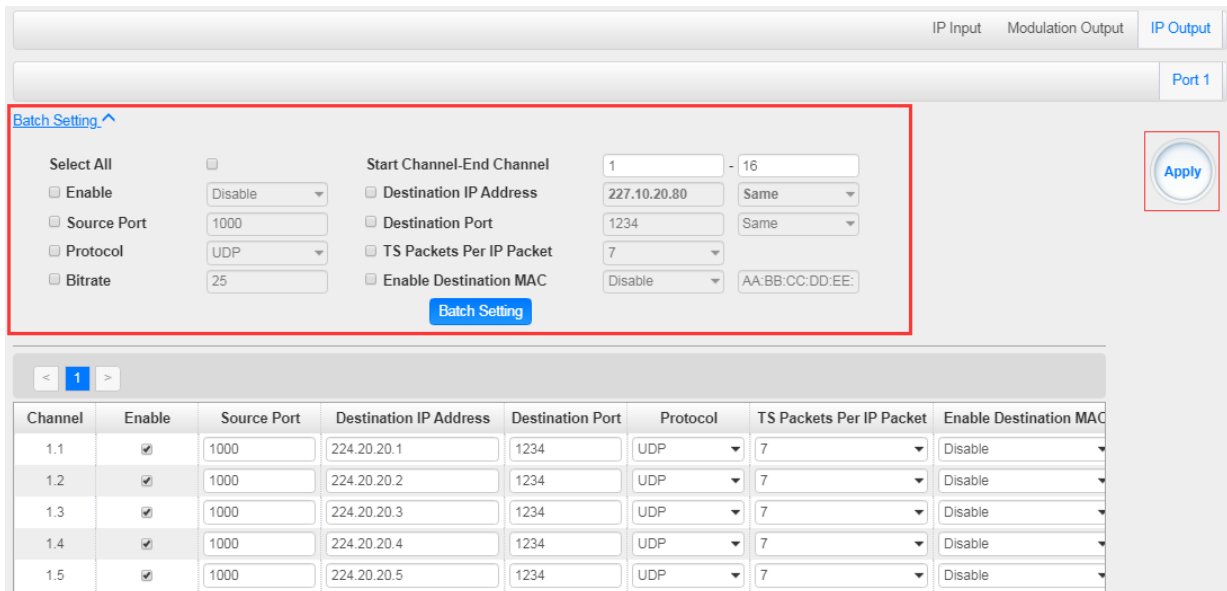

CM2-QAMB-02 > Multiplexing

Multiplexing has four tabs: **Source**, **Service Configuration**, **SI Table Setting** and **PID Transmission**. Here you are can set to output services from IP Input to Modulation Output. Click

Multiplexing to see 32 modulation output channels. Select a channel you want to configure and you will see **Source** setting of this channel.

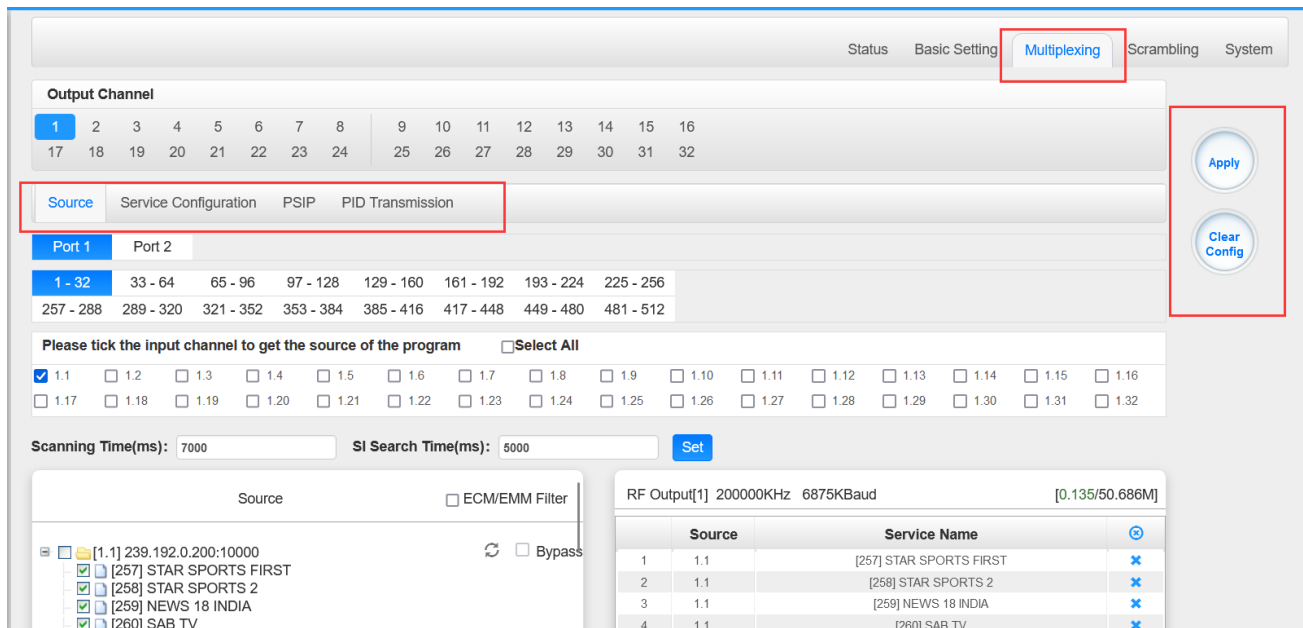

Multiplexing-Source> Source is where you select a source for output. You can chose **Port 1 2** for the source. Each port is divided into 16 groups to complete 512 channels. Select a Port and you can see service lists of Group and Channel as shown below.

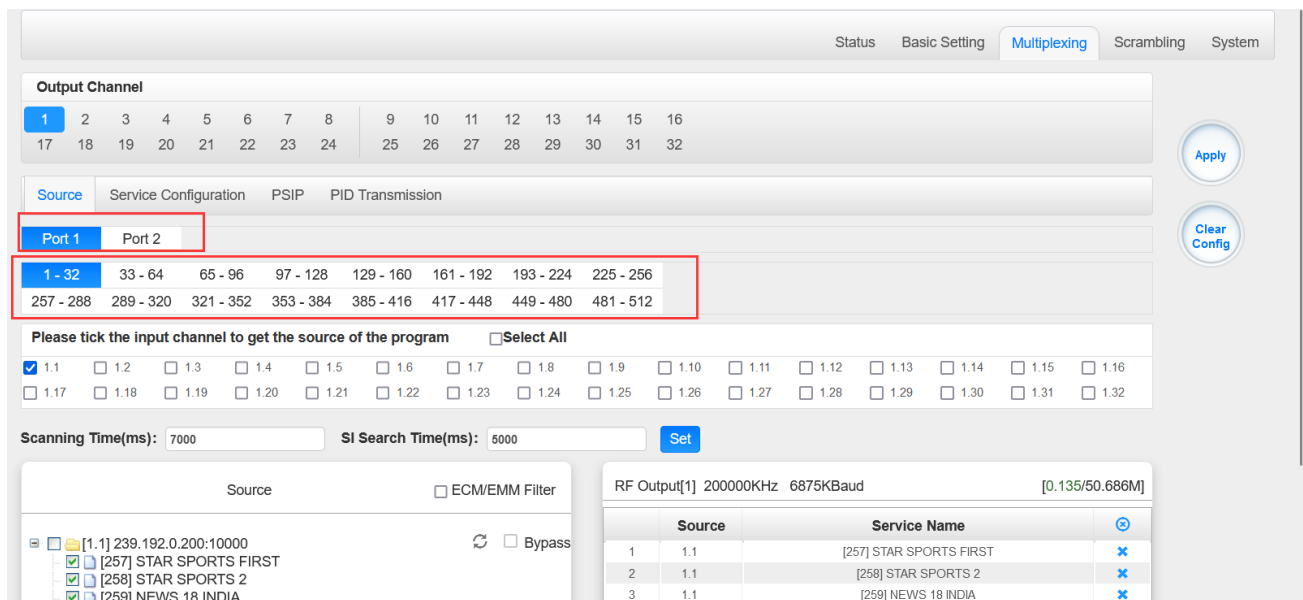

To output the service on the Modulation Output, you can simply put a tick in the box beside the service you want to output. You can output multiple Service from different Source channels or bypass the TS to Modulation output.

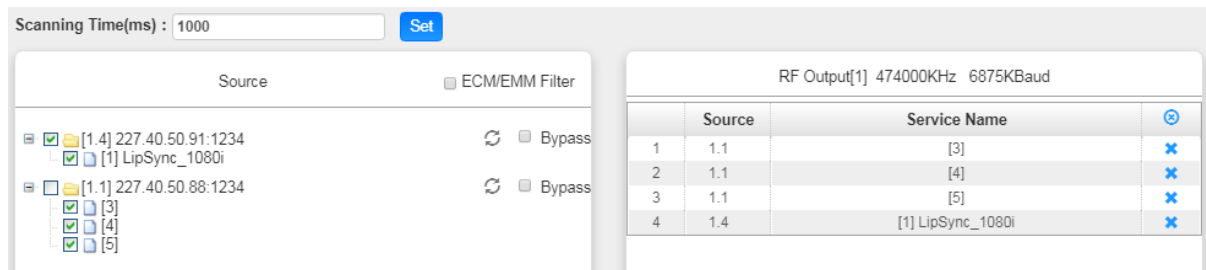

To Output the TS by Bypass mode, you can simply check the **Bypass** box of the TS. You can only bypass 1 TS and cannot output other services from different channel sources. Bypass mode allows you to keep the input signal automatically be redirected to Modulation output without re-scanning the input or transferring it to output.

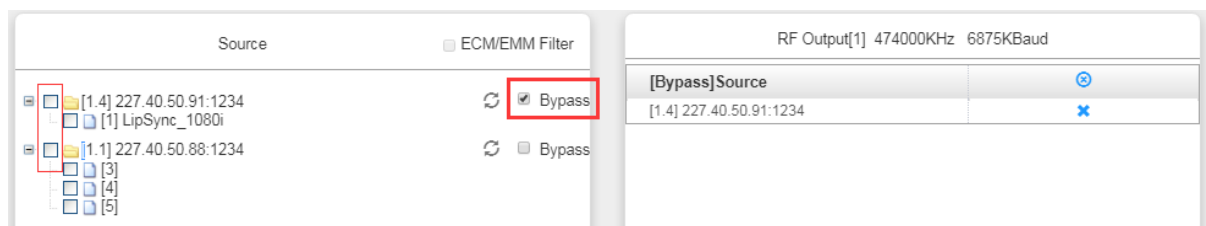

Multiplexing-Service Configuration> After output the services from IP input to Modulation output, you can now edit the Service ID and other PID on the output. Click on the Service Configuration to see this page, it shows the output service on this channel only.

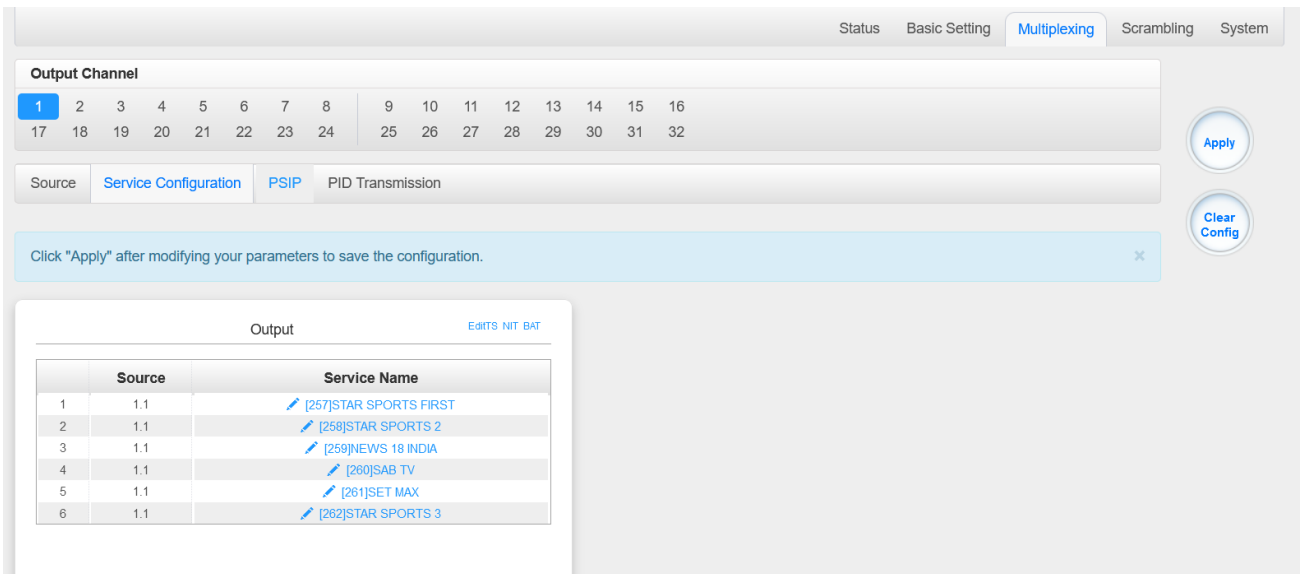

You can click the Name of the service and it will show a table where you can modify some information of the service like Service ID, Service Name, Service Provider, PCR2 PMT AUDIO and Video PID. Click OK & Apply for the changes to take effect.

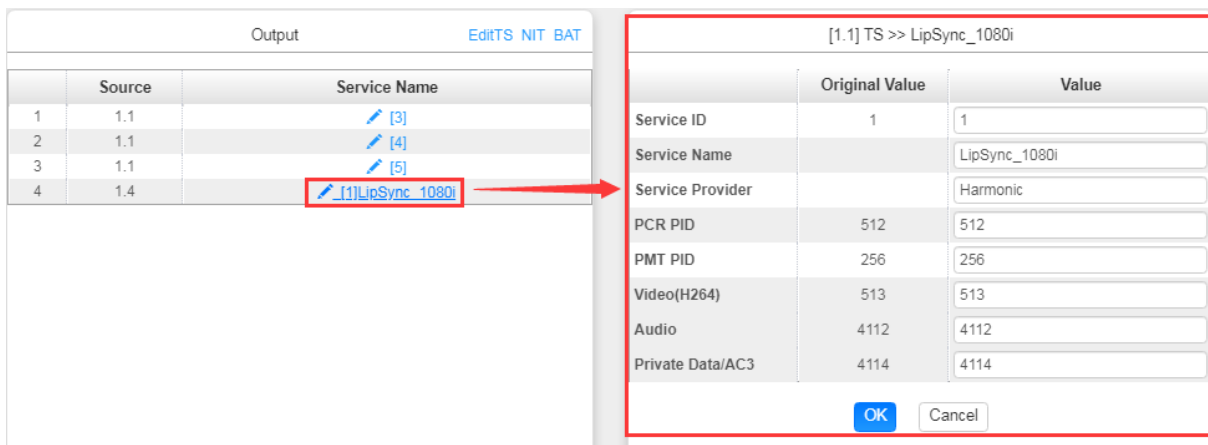

Here you can also edit the Original Network ID and TS ID of the Modulation Output.

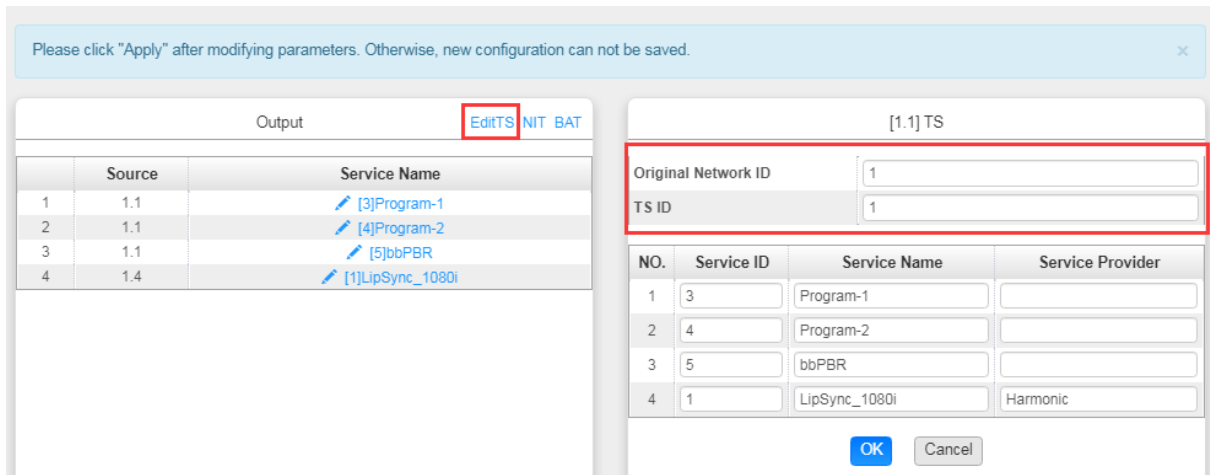

Here you can also edit NIT and create NIT Network for the OTA upgrade.

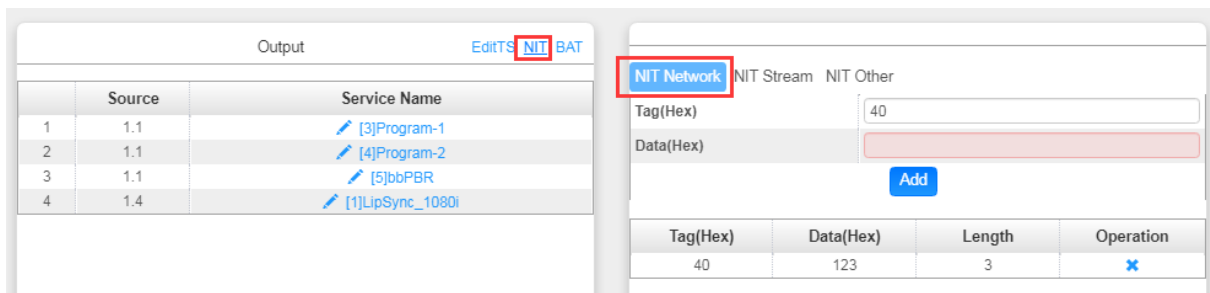

Still in NIT, you can also create NIT Streams and generate LCN for channel list and Cable Descriptor for frequency auto search.

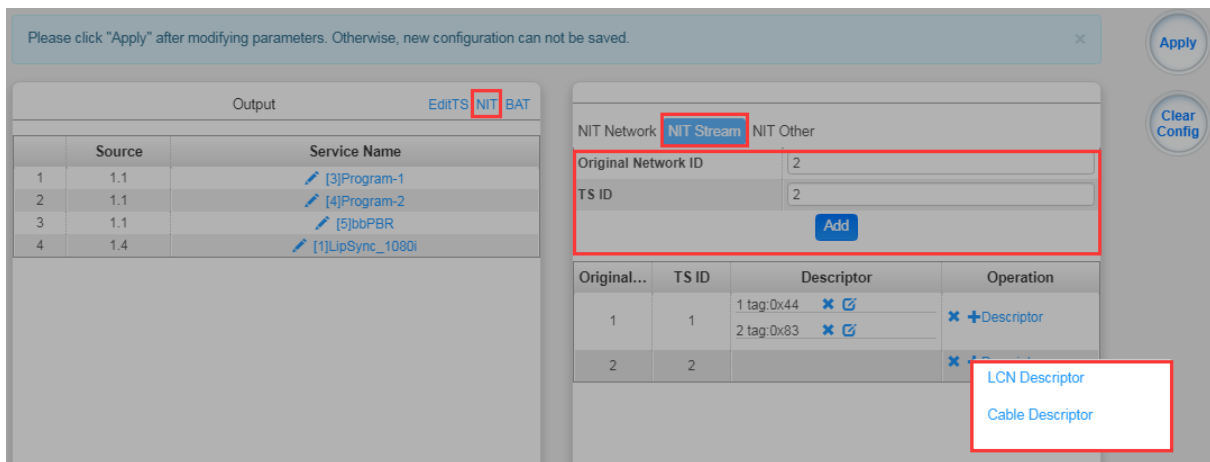

For the LCN Descriptor: input the Service ID and the LCN for the channel line-up of the services.

For the Cable Descriptor: input the correct frequency and Symbol Rate for the corresponding TS output. Cable descriptor depends on the setup you use. Mostly, Cable descriptor is created for 1 TS only. Some configuration need to be created in each TS.

Still in NIT, you can also create NIT Other.

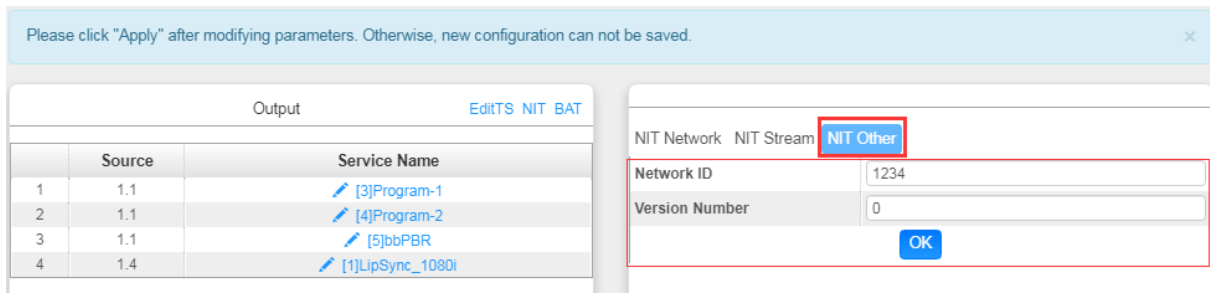

Here you can also create BAT.

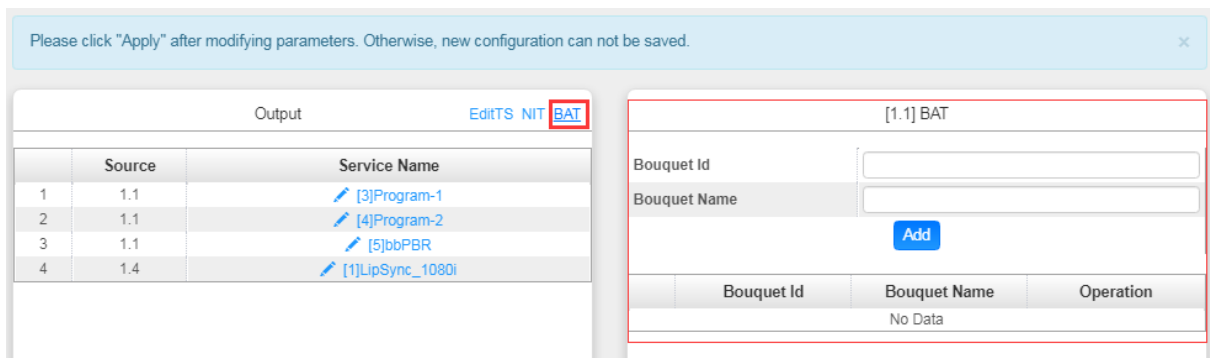

Multiplexing-SI Table Setting> This page is to choose whether to insert/generate the SI tables or Copy the SI tables from the input streams.

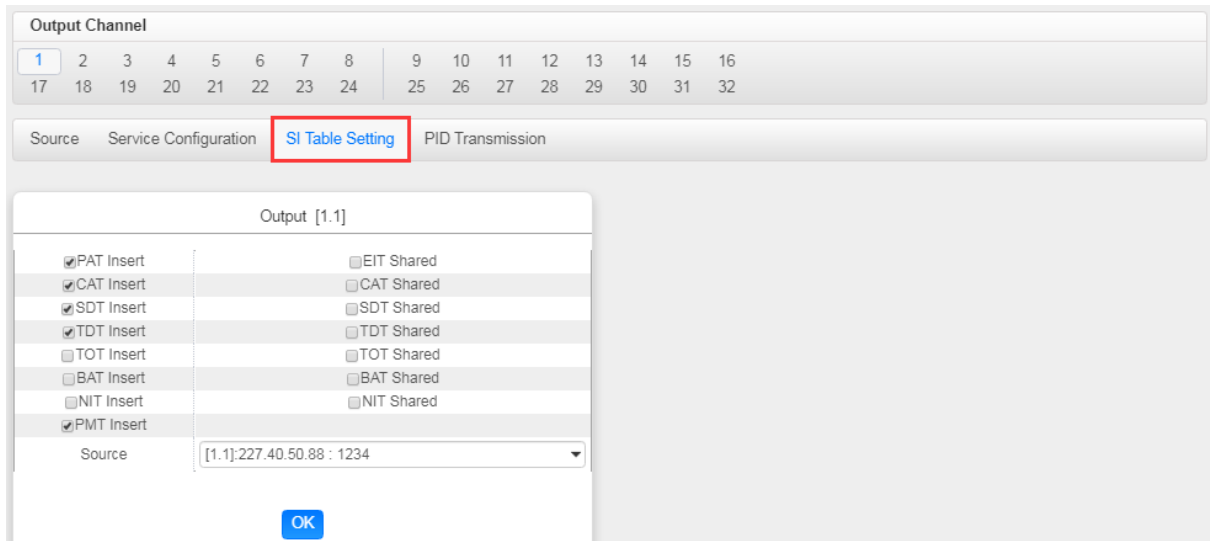

Multiplexing-PID Transmission> This page is to transmit the input PID to Output on the PID required by the system.

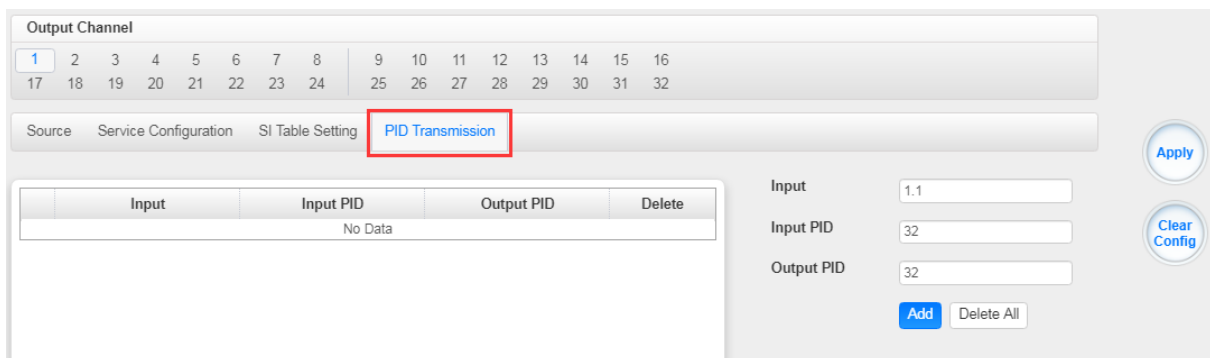

CM2-QAMB-02 > System

CM2-QAMB-02 System is composed of two sub menus namely Network and License.

Network> Here you can modify the IP Address, Subnet Mask and Gateway for each port of the module, except for the address of the module itself. This also shows the MAC Address of each port of the module. See the image below for reference.

CM-QAMB-02 Status Basic Setting Multiplexing **System**

Network Setting

Port	IP Address	Subnet Mask	Gateway	MAC Address	Link Speed	Link Status
NMS	192.168.1.11	255.255.255.0	192.168.1.254	A0:69:86:06:38:2F		
CAS	192.168.2.10	255.255.255.0	192.168.2.254	A0:69:86:06:38:30	auto	link down
DATA1	192.168.3.10	255.255.255.0	192.168.3.254	A0:69:86:06:38:31	auto	link down
DATA2	192.168.4.10	255.255.255.0	192.168.4.254	A0:69:86:06:38:32	auto	link down

Apply

License>Here you can import/export *license*, reboot module, *restore factory default settings* and *manage logs*.

CM-QAMB-02 Status Basic Setting Multiplexing **System**

Network **Setting**

Program Auto Scan

Enable **Set**

Clear all channel configuration

Clear

Configuration

Import Configuration **Browse** **Upload**

Export Configuration **Export**

License

Product ID DF3099990036

Import License **Browse** **Upload**

Export License **Export**





Logs

Open

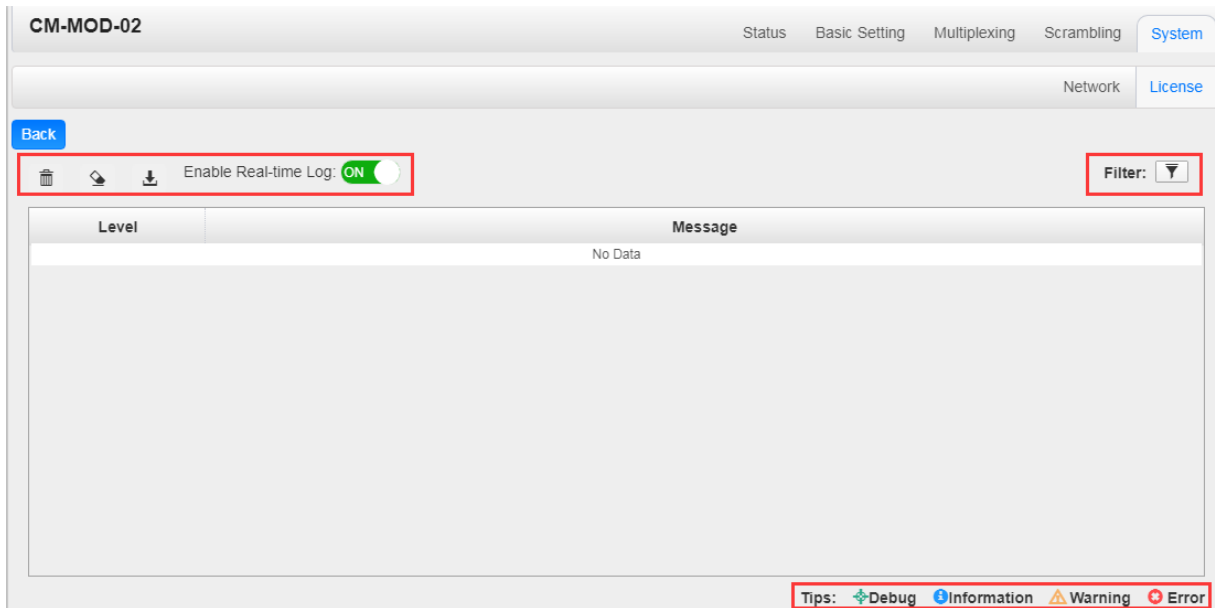
Log Manage>This page shows the logs of the module. If there are issues encountered on this module, exporting the logs will help R&D team to analyze and fix them.

Turn on **Enable Real-time Log** switch to see the real time log messages and the severity level of each message below.



- Click  to clear all log messages on the screen.
- Click  to delete all log information.
- Click  to export log information.
- Click  to filter desired log messages.

Clicking the filter icon, can simply select what logs to be included.

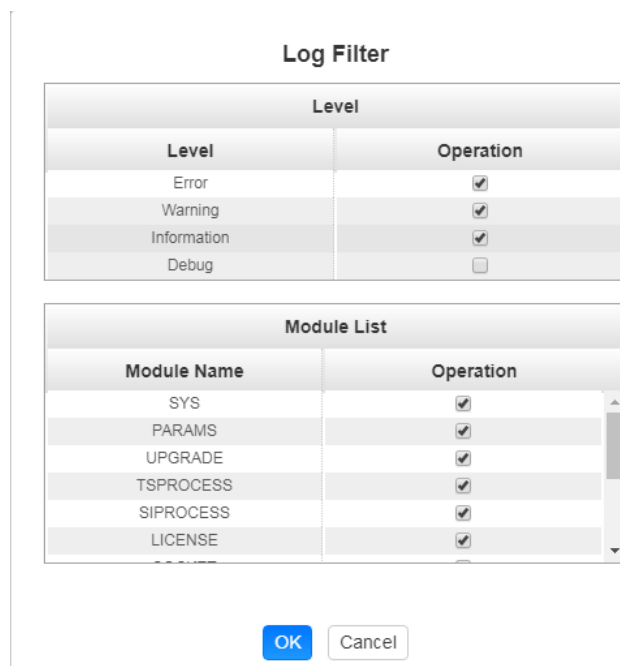

- CM2-QAMA-02 is as same as CM2-QAMB-02, In addition to supporting the scrambling function, it is not a default authorization and requires additional authorization

5.3.9 CM2-QAMA-R02

CM2-QAMA-R02 is a 16/32-channel QAM-A modulation output module with 2 gigabit IP input ports (single port supports 256-channel input), 1 CAS interface (RJ45) supporting scrambling and 1 RF output interface supporting up to 32 QAM-A non-adjacent frequencies modulating with independent constellation mode configuration.

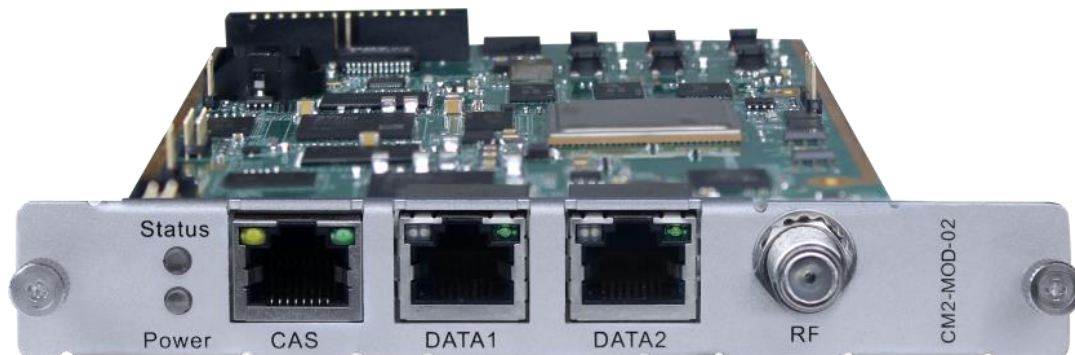

CM2-QAMA-R02 > Status

The Status page contains status information of IP Input, Modulation Output and IP Output.

IP Input >CM2-QAMA-R02 has 1024 IP input channels. Those channels are divided into two RJ45 ports, each port has 512 IP input channels. Click Port 1 tab, users can obtain the 256 channels status information such as ASI input source IP address and port number, total bitrate (Mbps) and effective bitrate (Mbps). The TS analysis and Service List button on each channel allow users to check the detailed information in each TS. See the image below for reference.

512 channels in port 1

CM-QAMA-R02 Status Basic Setting Multiplexing System

IP Input Modulation Output IP Output

Port 1 Port 2

Network Port Bitrate : 0.000 Mbps Total TS Bitrate : 0.000 Mbps

Channel	IP Address : Port	Effective Bitrate(Mbps)	Total Bitrate(Mbps)	TS Analysis	Service List
1.1	239.192.10.200 : 10000	0.000	0.000		
1.2	239.192.10.201 : 10000	0.000	0.000		
1.3	239.192.10.202 : 10000	0.000	0.000		
1.4	239.192.0.205 : 10000	0.000	0.000		
1.5	0.0.0.0 : 0	0.000	0.000		
1.6	0.0.0.0 : 0	0.000	0.000		
1.7	0.0.0.0 : 0	0.000	0.000		
1.8	0.0.0.0 : 0	0.000	0.000		
1.9	0.0.0.0 : 0	0.000	0.000		
1.10	0.0.0.0 : 0	0.000	0.000		

CM-QAMA-R02 Status Basic Setting Multiplexing System

IP Input Modulation Output IP Output

Port 1 Port 2

Network Port Bitrate : 0.000 Mbps Total TS Bitrate : 0.000 Mbps

Channel	IP Address : Port	Effective Bitrate(Mbps)	Total Bitrate(Mbps)	TS Analysis	Service List
1.1	239.192.10.200 : 10000	0.000	0.000		
1.2	239.192.10.201 : 10000	0.000	0.000		
1.3	239.192.10.202 : 10000	0.000	0.000		
1.4	239.192.0.205 : 10000	0.000	0.000		
1.5	0.0.0.0 : 0	0.000	0.000		
1.6	0.0.0.0 : 0	0.000	0.000		
1.7	0.0.0.0 : 0	0.000	0.000		
1.8	0.0.0.0 : 0	0.000	0.000		
1.9	0.0.0.0 : 0	0.000	0.000		
1.10	0.0.0.0 : 0	0.000	0.000		

Click the eye icon , users can know all the PIDs such as PAT, CAT, PCR2, Video Audio, PCR2 PID etc in this TS. See the image below for reference.

Channel	IP Address : Port	Effective Bitrate(Mbps)	Total Bitrate(Mbps)	TS Analysis	Service List
1.1	227.40.50.88 : 1234	22.960	24.603		
1.2	227.40.50.89 : 1234	26.267	28.141		
1.3	227.40.50.90 : 1234	26.256	28.130		
1.4	227.40.50.91 : 1234	9.520	10.085		
1.5	227.40.50.92 : 1234	26.094	27.383		
1.6	0.0.0.0 : 0	0.000	0.000		
1.7	0.0.0.0 : 0	0.000	0.000		
1.8	0.0.0.0 : 0	0.000	0.000		
1.9	0.0.0.0 : 0	0.000	0.000		

Channel 1.1 TS Analysis Reset Counter

Search

PID	Bitrate(Mbps)	Bandwidth(%)	Continuity Count Error	Type	Service
0x0(0)	0.022	0.113	0	PAT	
0x31(49)	13.098	67.180	0	PCR, Video	
0x34(52)	0.397	2.036	0	Audio	
0x35(53)	0.198	1.016	0	Audio	
0x41(65)	1.852	9.499	0	PCR, Video	
0x44(68)	0.198	1.016	0	Audio	
0x51(81)	2.143	10.991	0	PCR, Video	

[Tips](#)

If the input stream has multiple programs, users can click the icon below “Service List” to see all the services in this stream. See the image below for reference.

Channel	IP Address : Port	Effective Bitrate(Mbps)	Total Bitrate(Mbps)	TS Analysis	Service List
1.1	227.40.50.88 : 1234	18.455	19.764		
1.2	227.40.50.89 : 1234	18.446	19.750		
1.3	227.40.50.90 : 1234	18.446	19.750		
1.4	227.40.50.91 : 1234	9.521	10.064		
1.5	227.40.50.92 : 1234	19.179	20.129		
1.6	0.0.0.0 : 0	0.000	0.000		
1.7	0.0.0.0 : 0	0.000	0.000		
1.8	0.0.0.0 : 0	0.000	0.000		
1.9	0.0.0.0 : 0	0.000	0.000		

Channel : 1.1

#	Service
1	[3]
2	[4]
3	[5]

You can also check the details of a service by clicking the Service Name.

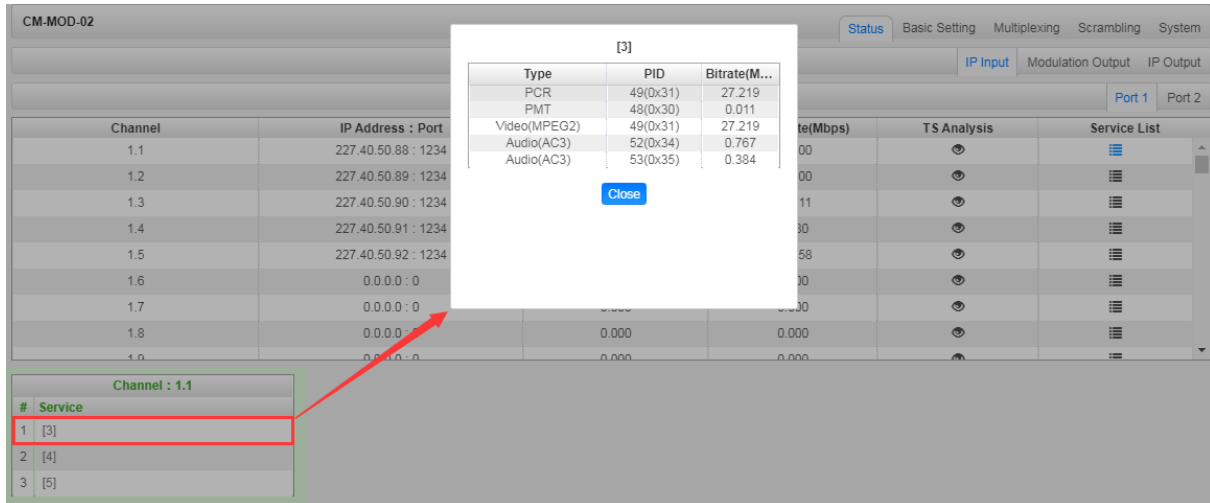

Modulation Output>CM2-QAMA-R02 status shows the Modulation output. Just like the IP Input, this shows the total bitrate and effective bitrate of the 32 channels respectively. The TS Analysis and Service List have the same function as in the IP input. The Status also shows the current temperature of the unit on the upper left corner. See image below for reference.

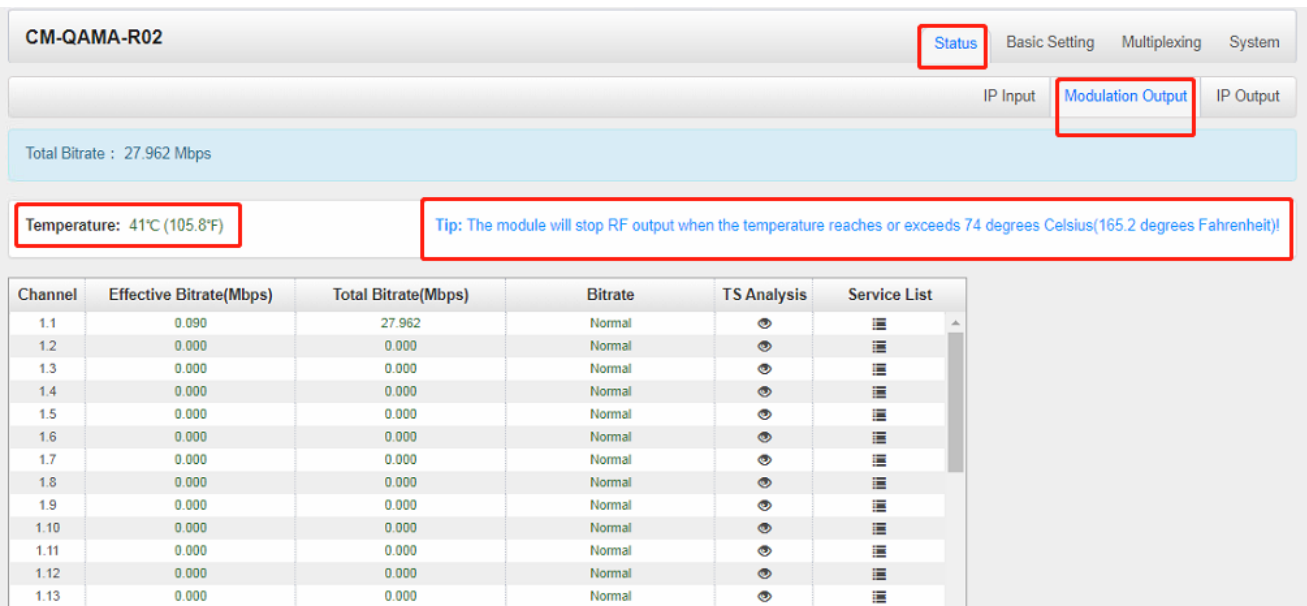

The screenshot displays the configuration for Channel 1.1. It features a main table with columns for Channel, Effective Bitrate(Mbps), Total Bitrate(Mbps), Bitrate, TS Analysis, and Service List. A red box highlights the first few rows of this table. To the right, a 'Channel : 1.1' panel shows a 'Service List' table with three entries. Below this, the 'Channel 1.1 TS Analysis' section contains a search bar and a table with columns for PID, Bitrate(Mbps), Bandwidth(%), Continuity Count Error, Type, and Service.

Channel	Effective Bitrate(Mbps)	Total Bitrate(Mbps)	Bitrate	TS Analysis	Service List
1.19	0.000	0.000	Normal	👁️	☰
1.20	0.000	0.000	Normal	👁️	☰
1.21	0.000	0.000	Normal	👁️	☰
1.22	0.000	0.000	Normal	👁️	☰
1.23	0.000	0.000	Normal	👁️	☰
1.24	0.000	0.000	Normal	👁️	☰
1.25	0.000	0.000	Normal	👁️	☰
1.26	0.000	0.000	Normal	👁️	☰
1.27	0.000	0.000	Normal	👁️	☰
1.28	0.000	0.000	Normal	👁️	☰
1.29	0.000	0.000	Normal	👁️	☰
1.30	0.000	0.000	Normal	👁️	☰
1.31	0.000	0.000	Normal	👁️	☰
1.32	0.000	0.000	Normal	👁️	☰

#	Service
1	[3]
2	[4]
3	[5]

PID	Bitrate(Mbps)	Bandwidth(%)	Continuity Count Error	Type	Service
0x0(0)	0.015	0.039	84	PAT	
0x11(17)	0.015	0.039	37	SDT, BAT	
0x30(48)	0.015	0.039	99	PMT	
0x31(49)	0.000	0.000	127	PCR, Video	
0x34(52)	0.000	0.000	127	Audio	
0x35(53)	0.000	0.000	57	Audio	

IP Output>CM2-QAM-R02 status also shows the IP output. Just like the IP Input, this shows the total bitrate and effective bitrate of the 16 channels respectively. The TS Analysis and Service List have the same function as in the IP input. See image below for reference.

The screenshot shows the 'Status' page for CM-QAMA-R02. It includes tabs for 'IP Input', 'Modulation Output', and 'IP Output'. A 'Port 1' tab is selected. A blue bar indicates 'Total Bitrate : 26.983 Mbps'. Below is a table with columns for Channel, IP Address : Port, Effective Bitrate(Mbps), Total Bitrate(Mbps), Bitrate, TS Analysis, and Service List. A red box highlights the entire table.

Channel	IP Address : Port	Effective Bitrate(Mbps)	Total Bitrate(Mbps)	Bitrate	TS Analysis	Service List
1.1	224.20.20.1 : 1234	0.090	26.983	Normal	👁️	☰
1.2	0.0.0.0	0.000	0.000	Normal	👁️	☰
1.3	0.0.0.0	0.000	0.000	Normal	👁️	☰
1.4	0.0.0.0	0.000	0.000	Normal	👁️	☰
1.5	0.0.0.0	0.000	0.000	Normal	👁️	☰
1.6	0.0.0.0	0.000	0.000	Normal	👁️	☰
1.7	0.0.0.0	0.000	0.000	Normal	👁️	☰
1.8	0.0.0.0	0.000	0.000	Normal	👁️	☰
1.9	0.0.0.0	0.000	0.000	Normal	👁️	☰
1.10	0.0.0.0	0.000	0.000	Normal	👁️	☰
1.11	0.0.0.0	0.000	0.000	Normal	👁️	☰
1.12	0.0.0.0	0.000	0.000	Normal	👁️	☰
1.13	0.0.0.0	0.000	0.000	Normal	👁️	☰
1.14	0.0.0.0	0.000	0.000	Normal	👁️	☰
1.15	0.0.0.0	0.000	0.000	Normal	👁️	☰

Channel	IP Address : Port	Effective Bitrate(M...	Total Bitrate(Mb...	Bitrate	TS Analysis	Service List
1.3	224.20.20.3 : 1234	0.045	37.714	Normal	👁	☰
1.4	224.20.20.4 : 1234	0.060	37.715	Normal	👁	☰
1.5	224.20.20.5 : 1234	0.060	37.714	Normal	👁	☰
1.6	224.20.20.6 : 1234	0.000	0.000	Normal	👁	☰
1.7	224.20.20.7 : 1234	0.000	0.000	Normal	👁	☰
1.8	224.20.20.8 : 1234	0.000	0.000	Normal	👁	☰
1.9	0.0.0.0 : 0	0.000	0.000	Normal	👁	☰
1.10	0.0.0.0 : 0	0.000	0.000	Normal	👁	☰
1.11	0.0.0.0 : 0	0.000	0.000	Normal	👁	☰
1.12	0.0.0.0 : 0	0.000	0.000	Normal	👁	☰
1.13	0.0.0.0 : 0	0.000	0.000	Normal	👁	☰
1.14	0.0.0.0 : 0	0.000	0.000	Normal	👁	☰
1.15	0.0.0.0 : 0	0.000	0.000	Normal	👁	☰
1.16	0.0.0.0 : 0	0.000	0.000	Normal	👁	☰

CM2-QAMA-R02 > Basic Setting

CM2-QAMA-R02 Basic Setting is where users input the parameters for IP Input, Modulation Output and IP Output.

IP Input-Parameter Setting> On this page, there are three tabs where you can modify the multicast IP, port and parameter of IP Input. There are **Port 1**, **Port 2**, and **Batch Setting**. The input can accept Multicast or Unicast and support MPTS and SPTS.

Port 1 and Port 2 have same interface. It shows the 512 channels. Check the box under **Enable** to enable a channel. Input the correct Multicast/Unicast IP address and IP port, and select the correct Protocol for the source IP. Once done, click **Apply** for the changes to take effect. See the image below for reference.

CM-QAMA-R02 Status **Basic Setting** Multiplexing System

IP Input Modulation Output **IP Output**

Port 1 **Port 2**

Batch Setting ▾

Channel	Enable	Source Port	Destination IP Address	Destination Port	Protocol	Pkt Length	Enable Destination MAC	Destination MAC
1.1	<input checked="" type="checkbox"/>	1000	224.20.20.1	1234	UDP	7	Disable	01:00:5E:14:14:01
1.2	<input type="checkbox"/>	1000	224.20.20.2	1234	UDP	7	Disable	00:00:00:00:00:00
1.3	<input type="checkbox"/>	1000	224.20.20.3	1234	UDP	7	Disable	00:00:00:00:00:00
1.4	<input type="checkbox"/>	1000	224.20.20.4	1234	UDP	7	Disable	00:00:00:00:00:00
1.5	<input type="checkbox"/>	1000	224.20.20.5	1234	UDP	7	Disable	00:00:00:00:00:00
1.6	<input type="checkbox"/>	1000	224.20.20.6	1234	UDP	7	Disable	00:00:00:00:00:00
1.7	<input type="checkbox"/>	1000	224.20.20.7	1234	UDP	7	Disable	00:00:00:00:00:00
1.8	<input type="checkbox"/>	1000	224.20.20.8	1234	UDP	7	Disable	00:00:00:00:00:00
1.9	<input type="checkbox"/>	1000	224.20.20.9	1234	UDP	7	Disable	00:00:00:00:00:00
1.10	<input type="checkbox"/>	1000	224.20.20.10	1234	UDP	7	Disable	00:00:00:00:00:00

Apply

Batch Setting is where users can input the IP input parameters in batch. See the image below for reference.

The screenshot shows the 'Batch Setting' interface for 'IP Input'. It features a configuration panel with various options and a table of channel settings.

Batch Setting Configuration:

- Select All:
- Enable: (Disable)
- Protocol: (UDP)
- Enable VLAN: (Disable)
- Start Channel-End Channel: 1 - 256
- Destination IP Address: 227.10.20.80 (Same)
- Destination Port: 1234 (Same)
- VLAN ID: 1
- TS Packets Per IP Packet: 7

Batch Setting Table:

Channel	Enable	Destination IP Add...	Destination Port	Protocol	TS Packets Per IP ...	VLAN Enable	VLAN ID
1.1	<input checked="" type="checkbox"/>	227.40.50.88	1234	UDP	7	Disable	1
1.2	<input checked="" type="checkbox"/>	227.40.50.89	1234	UDP	7	Disable	1
1.3	<input checked="" type="checkbox"/>	227.40.50.90	1234	UDP	7	Disable	1
1.4	<input checked="" type="checkbox"/>	227.40.50.91	1234	UDP	7	Disable	1
1.5	<input checked="" type="checkbox"/>	227.40.50.92	1234	UDP	7	Disable	1
1.6	<input type="checkbox"/>	227.10.20.6	1234	UDP	7	Disable	1
1.7	<input type="checkbox"/>	227.10.20.7	1234	UDP	7	Disable	1

Modulation Output-Parameter Setting On this page, you can enable channels as you need and input the Frequency (KHz), QAM Mode, Symbol Rate (KBaud) and RF Level Gain (dBmV) to have an output.

The screenshot shows the 'Modulation Output-Parameter Setting' interface for 'CM-QAMA-R02'. It includes a configuration panel and a table of channel settings.

Modulation Output Configuration:

- RF Level: 40 (dBmV selected, dBuV unselected)
- PSI/SI Interval(ms): 100

Modulation Output Table:

Channel	Enable	Frequency(KHz)	QAM Mode	SymbolRate(KBaud)	RF Level Gain (dB)
1.1	<input checked="" type="checkbox"/>	57000	QAM64	5057	0
1.2	<input checked="" type="checkbox"/>	63000	QAM64	5057	0
1.3	<input type="checkbox"/>	69000	QAM64	5057	0
1.4	<input type="checkbox"/>	79000	QAM64	5057	0
1.5	<input type="checkbox"/>	85000	QAM64	5057	0
1.6	<input type="checkbox"/>	177000	QAM64	5057	0
1.7	<input type="checkbox"/>	183000	QAM64	5057	0
1.8	<input type="checkbox"/>	189000	QAM64	5057	0
1.9	<input type="checkbox"/>	195000	QAM64	5057	0
1.10	<input type="checkbox"/>	201000	QAM64	5057	0
1.11	<input type="checkbox"/>	207000	QAM64	5057	0

Here is the range parameter of the above info.

Name	Range	Name	Range
Symbol Rate	3600~3956	RF level gain	-10`~0 (multiples of 0.5)
Frequency (KHz)	48000~862000	QAM Mode	QAM16/QAM32/QAM64/QAM128/QAM256

You can also set the RF level in a range of 85 to 112 as shown in the image below.

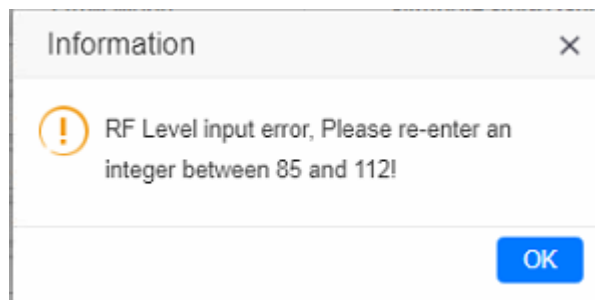

Batch Setting is where you can input the modulation parameters in batch. See the image below for reference.

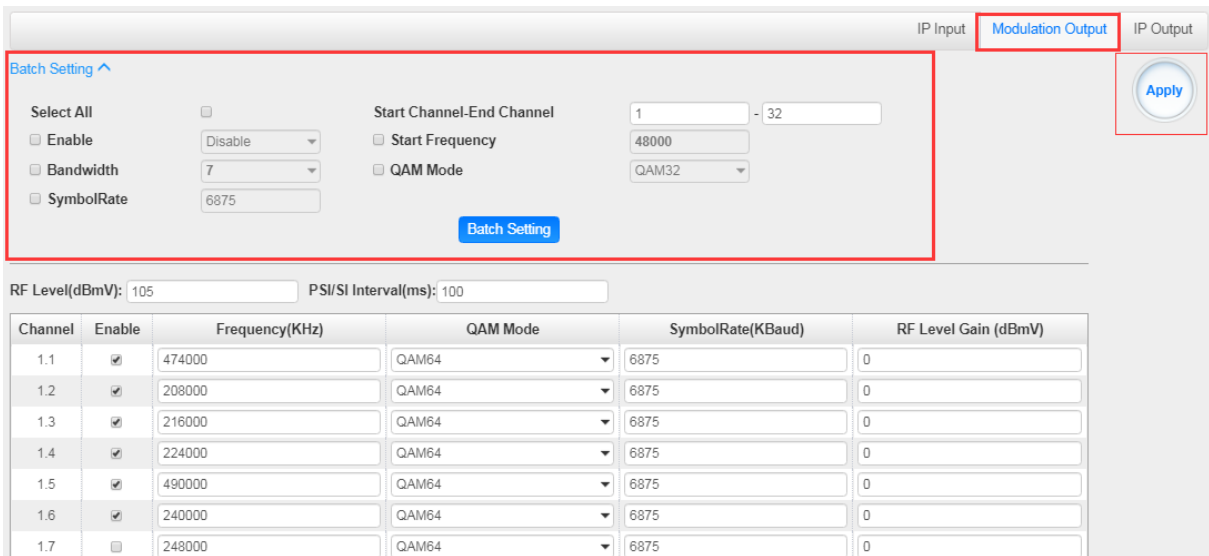

IP Output-Parameter Setting On this page, there are three tabs where you can modify the multicast IP, port and parameter of IP Output. There are **Port 1**, **Port 2** and **Batch Setting**. The output can accept Multicast or Unicast and support MPTS and SPTS.

Port 1 shows the 16 channels. Check the box under Enable to enable a channel. Input the correct Multicast/Unicast IP address, IP port and appropriate output bitrate, and select the correct Protocol for the output IP. Once done, click **Apply** for the changes to take effect. See the image below for reference.

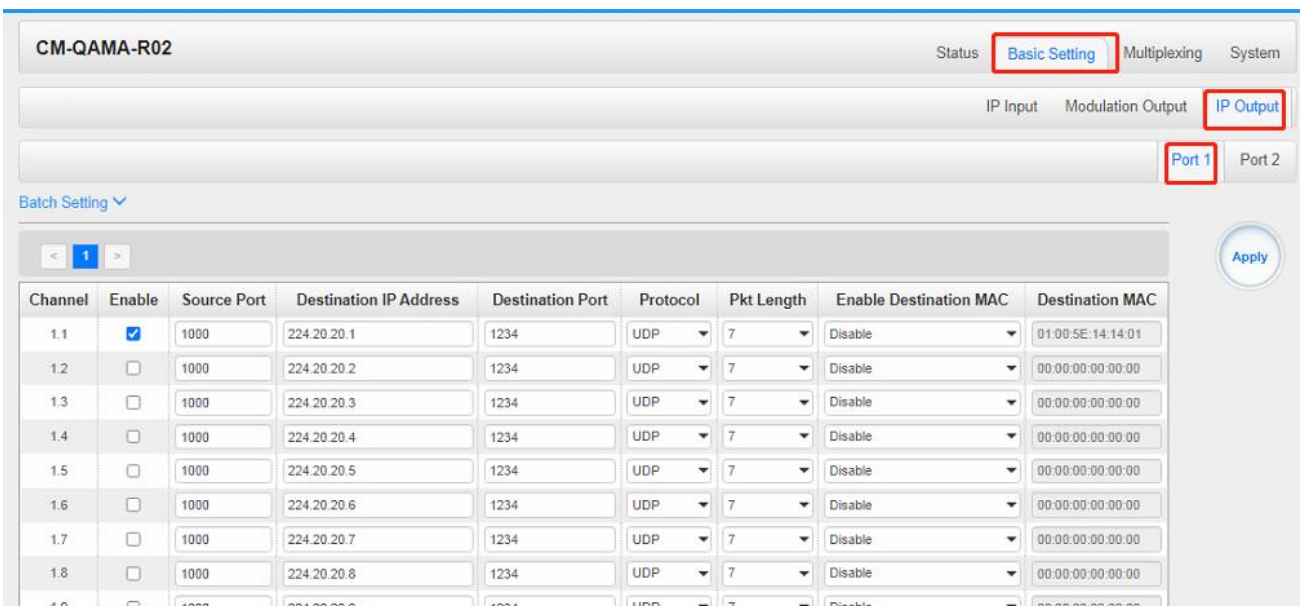

Batch Setting is where you can input the IP output parameters in batch. See the image below for reference.

The screenshot shows the 'Batch Setting' configuration interface for IP Output. The interface is divided into several sections:

- Batch Setting Section (highlighted with a red box):**
 - Select All:** A checkbox that is currently unchecked.
 - Enable:** A dropdown menu set to 'Disable'.
 - Source Port:** A text input field containing '1000'.
 - Protocol:** A dropdown menu set to 'UDP'.
 - Bitrate:** A text input field containing '25'.
 - Start Channel-End Channel:** Two text input fields containing '1' and '16' respectively.
 - Destination IP Address:** A text input field containing '227.10.20.80' and a dropdown menu set to 'Same'.
 - Destination Port:** A text input field containing '1234' and a dropdown menu set to 'Same'.
 - TS Packets Per IP Packet:** A dropdown menu set to '7'.
 - Enable Destination MAC:** A dropdown menu set to 'Disable' and a text input field containing 'AA:BB:CC:DD:EE:'.
 - Buttons:** A blue 'Batch Setting' button and a blue 'Apply' button (circled in red).
- Channel Configuration Table:**

Channel	Enable	Source Port	Destination IP Address	Destination Port	Protocol	TS Packets Per IP Packet	Enable Destination MAC
1.1	<input checked="" type="checkbox"/>	1000	224.20.20.1	1234	UDP	7	Disable
1.2	<input checked="" type="checkbox"/>	1000	224.20.20.2	1234	UDP	7	Disable
1.3	<input checked="" type="checkbox"/>	1000	224.20.20.3	1234	UDP	7	Disable
1.4	<input checked="" type="checkbox"/>	1000	224.20.20.4	1234	UDP	7	Disable
1.5	<input checked="" type="checkbox"/>	1000	224.20.20.5	1234	UDP	7	Disable

CM2-QAMA-R02 > Multiplexing

Multiplexing has four tabs: **Source**, **Service Configuration**, **SI Table Setting** and **PID**

Transmission. Here you can set to output services from IP Input to Modulation Output. Click **Multiplexing** to see 32 modulation output channels. Select a channel you want to configure and you will see **Source** setting of this channel.

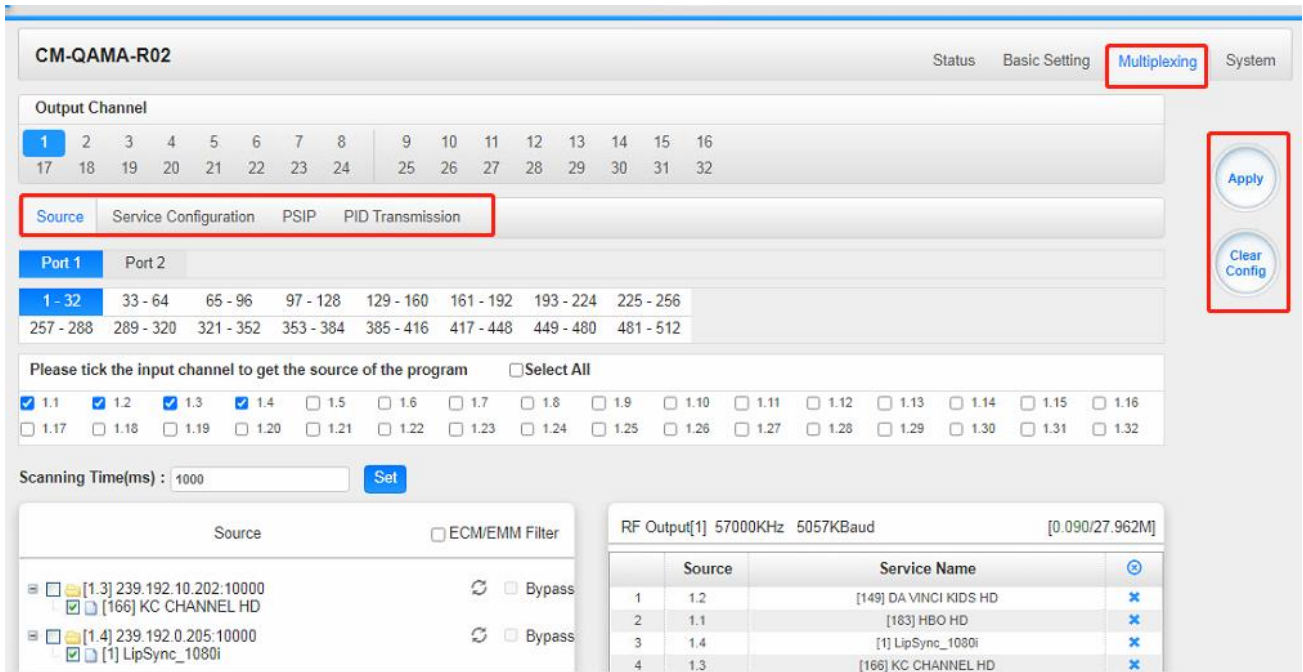

Multiplexing-Source> Source is where you select a source for output. You can chose **Port 1** **2** for the source. Each port is divided into 16 groups to complete 512 channels. Select a Port and you can see service lists of Group and Channel as shown below.

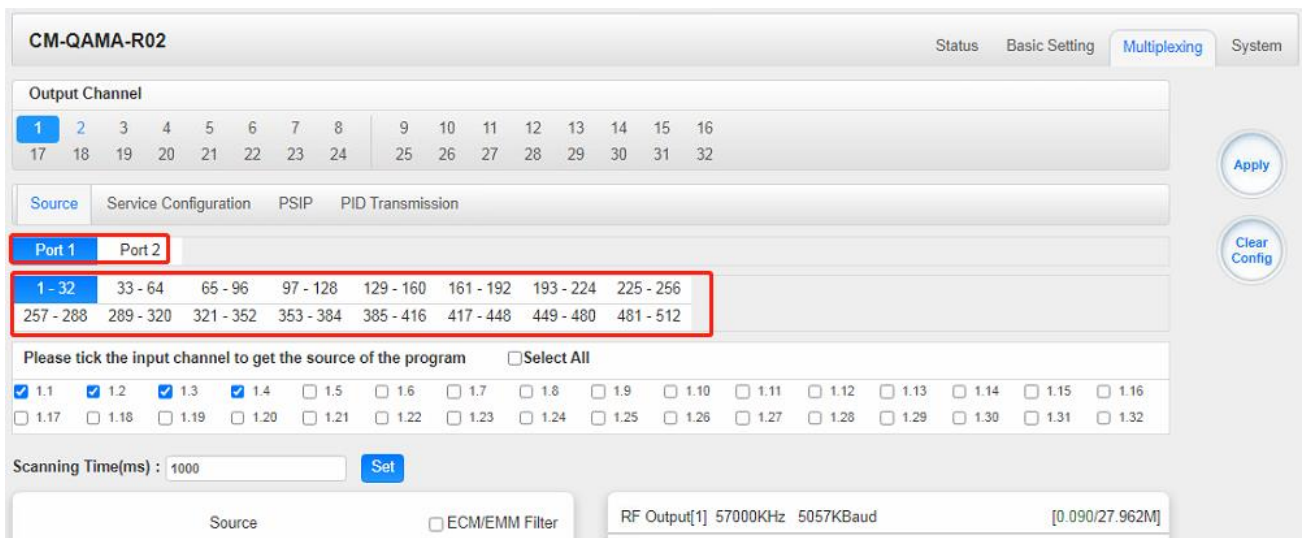

To output the service on the Modulation Output, you can simply put a tick in the box beside the service you want to output. You can output multiple Service from different Source bypass the TS to Modulation output.

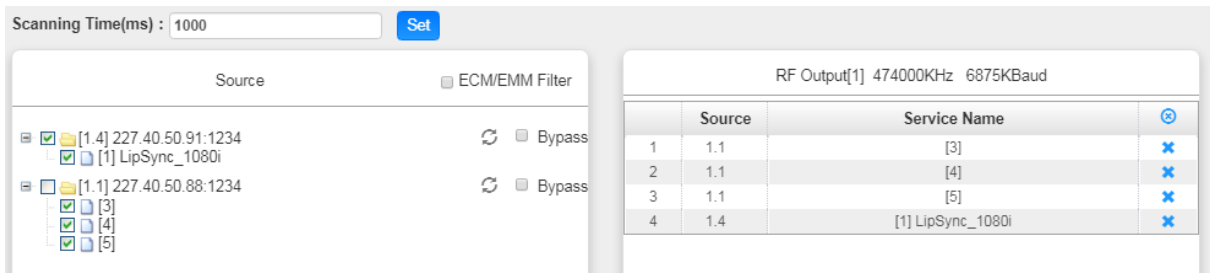

To Output the TS by Bypass mode, you can simply check the **Bypass** box of the TS. You can only bypass 1 TS and cannot output other services from different channel sources. Bypass mode allows you to keep the input signal automatically be redirected to Modulation output without re-scanning the input or transferring it to output.

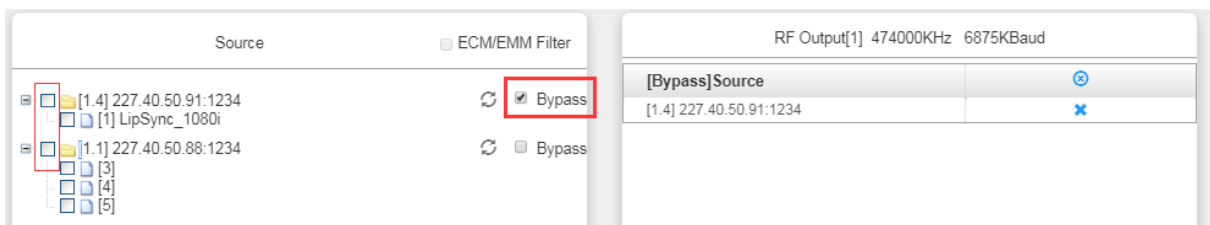

Multiplexing-Service Configuration> After output the services from IP input to Modulation output, you can now edit the Service ID and other PID on the output. Click on the Service Configuration to see this page, it shows the output service on this channel only.

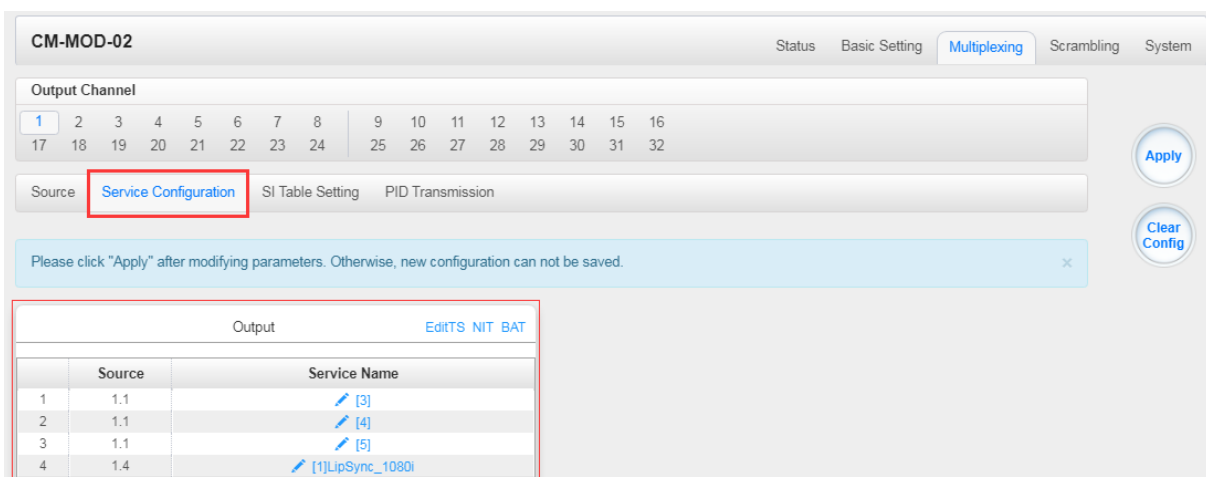

You can click the Name of the service and it will show a table where you can modify some information of the service like Service ID, Service Name, Service Provider, PCR2 PMT AUDIO and Video PID. Click OK & Apply for the changes to take effect.

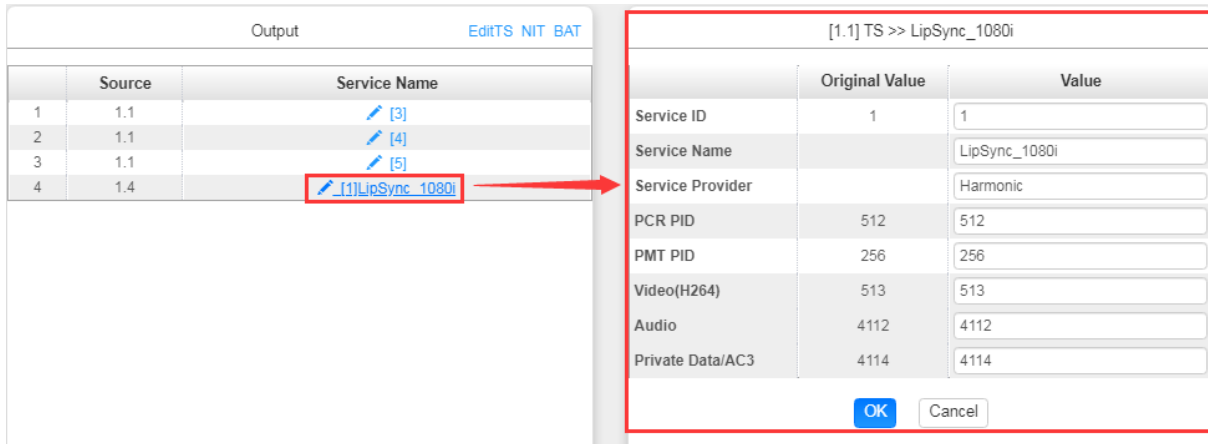

Here you can also edit the Original Network ID and TS ID of the Modulation Output.

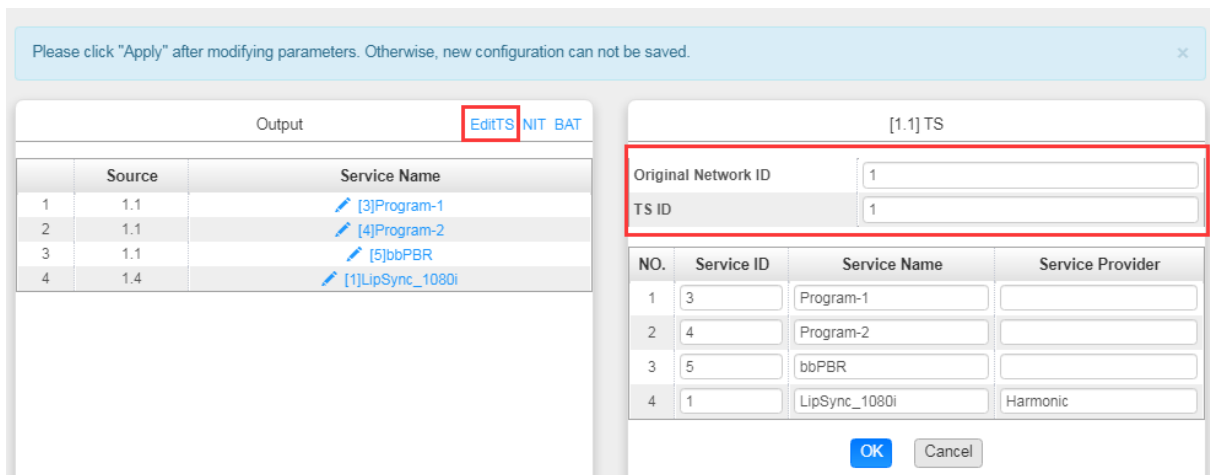

Here you can also edit NIT and create NIT Network for the OTA upgrade.

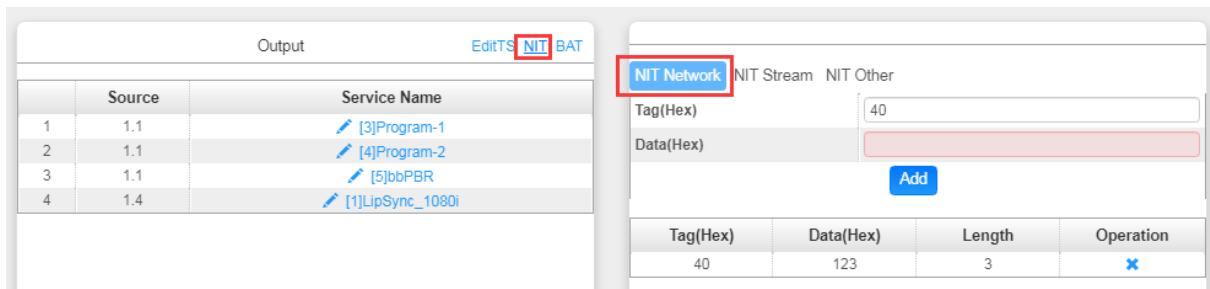

Still in NIT, you can also create NIT Streams and generate LCN for channel list and Cable Descriptor for frequency auto search.

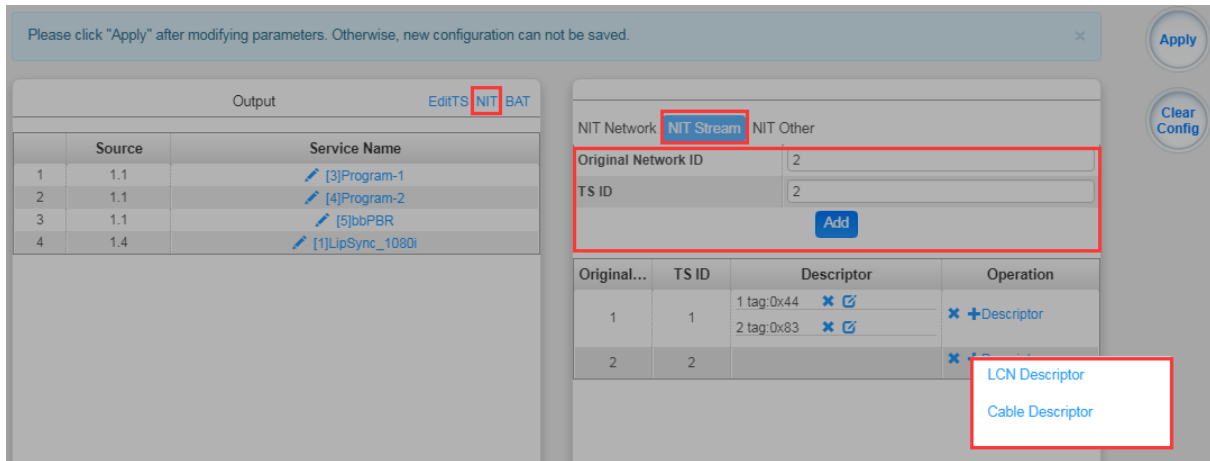

For the LCN Descriptor: input the Service ID and the LCN for the channel line-up of the services.

For the Cable Descriptor: input the correct frequency and Symbol Rate for the corresponding TS output. Cable descriptor depends on the setup you use. Mostly, Cable descriptor is created for 1 TS only. Some configuration need to be created in each TS.

Still in NIT, you can also create NIT Other.

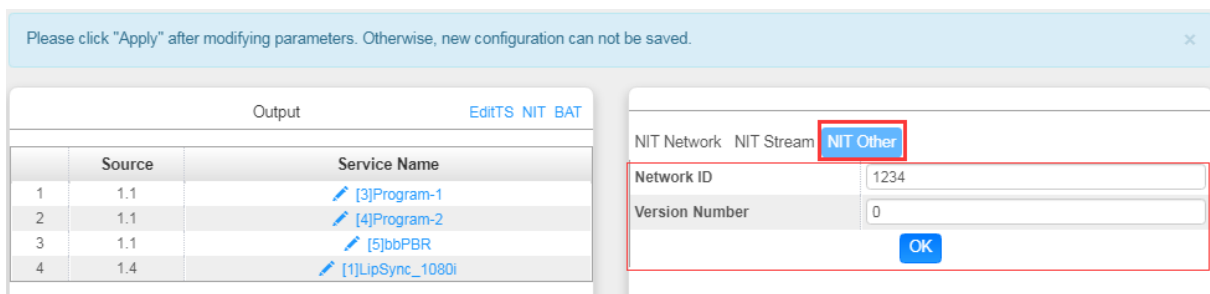

Here you can also create BAT.

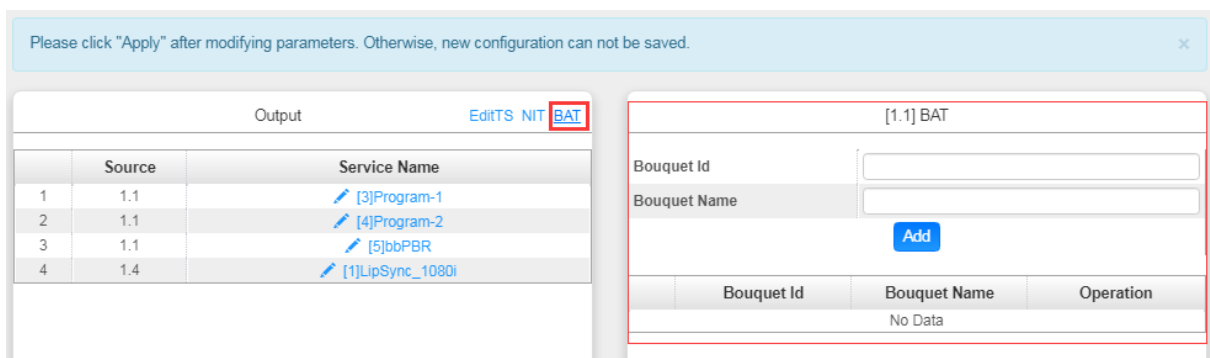

Multiplexing-SI Table Setting> This page is to choose whether to insert/generate the SI tables or Copy the SI tables from the input streams.

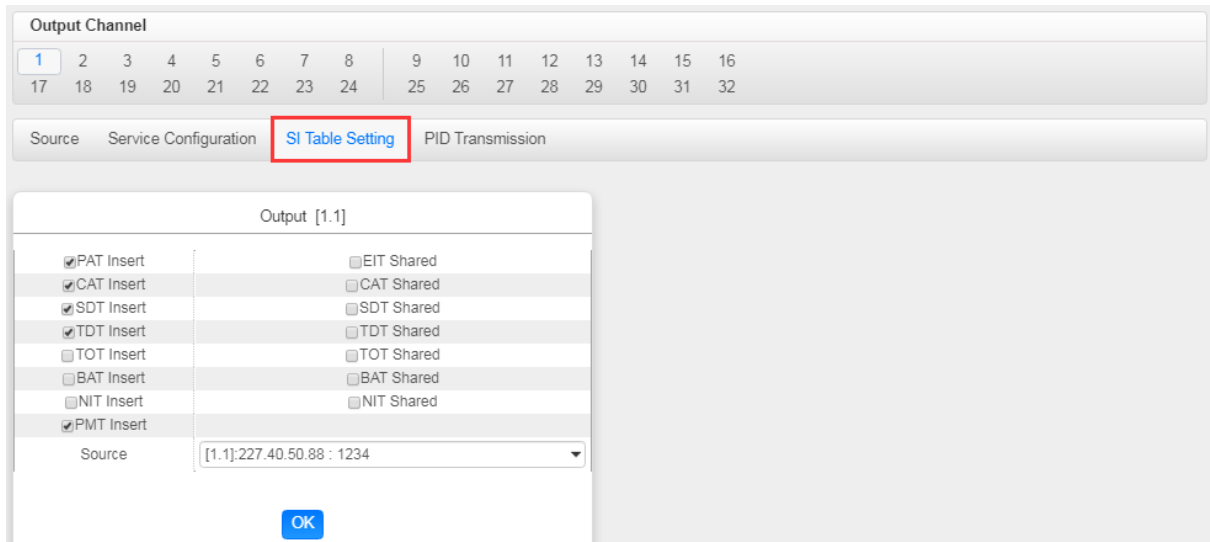

Multiplexing-PID Transmission> This page is to transmit the input PID to Output on the PID required by the system.

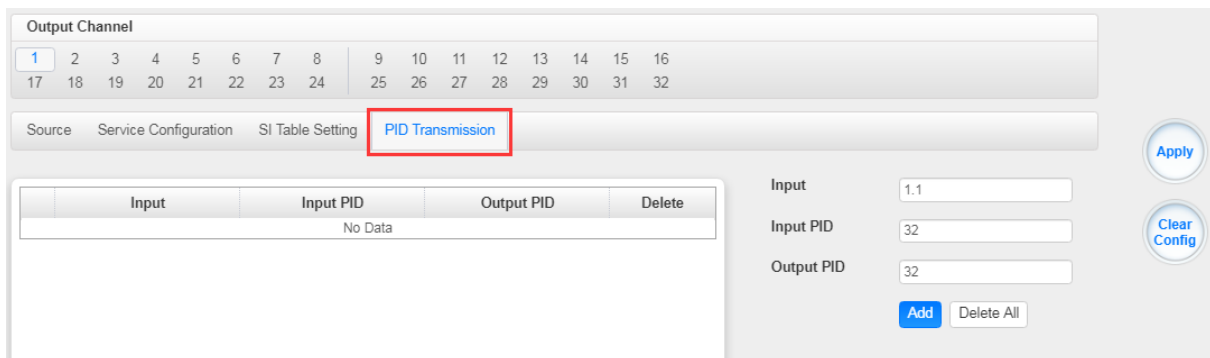

CM2-QAMA-R02 > Scrambling

CM2-QAMA-R02 Scramble is where you can encrypt a service on the Modulation Output. Scrambler can be connected 6 different CAS simultaneously. There are seven tabs on this page namely Service Scrambling and CAS1 to CAS6. 6 CAS tabs have the same interface.

Input the correct CA parameters on this page and make sure the ECMG and EMMG are connected GREEN. Some CA will provide a Super CAS ID with 8 digits. This is a combination of the 4-digit CAS System ID and 4-digit of ECMG Sub System ID.

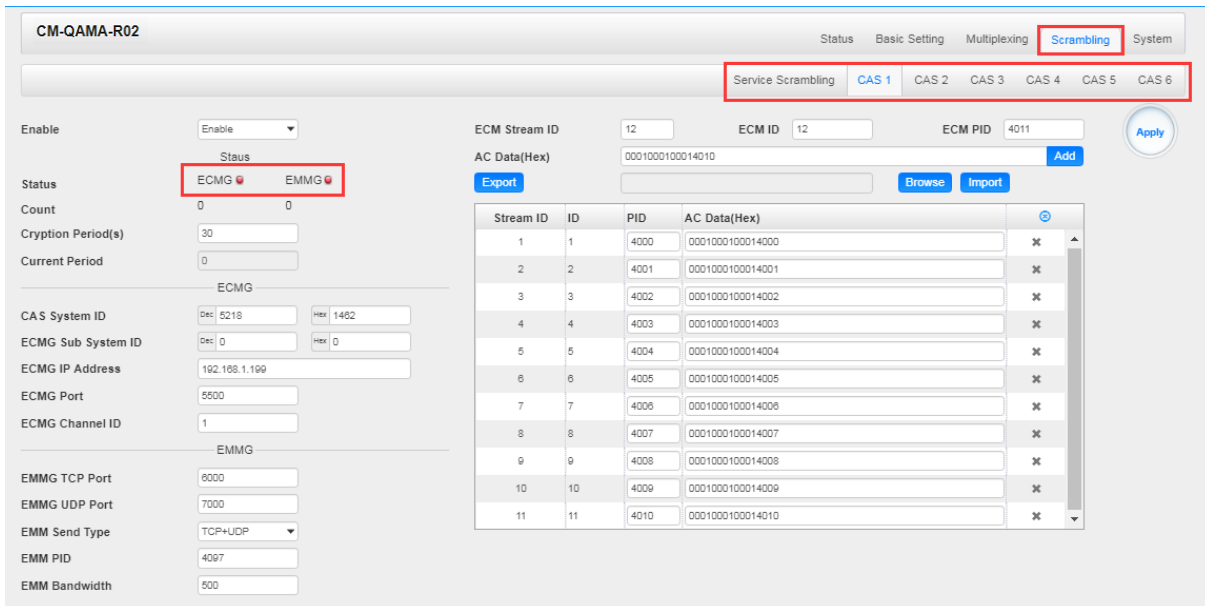

Service Scrambling On this page, you can encrypt a service in the Modulation Output. Select a channel for output and you will see a service list. The module supports up to 6 different CA, select one of them for encryption as you need, then select the CA ID of the service. Click **Apply** to finish setting.

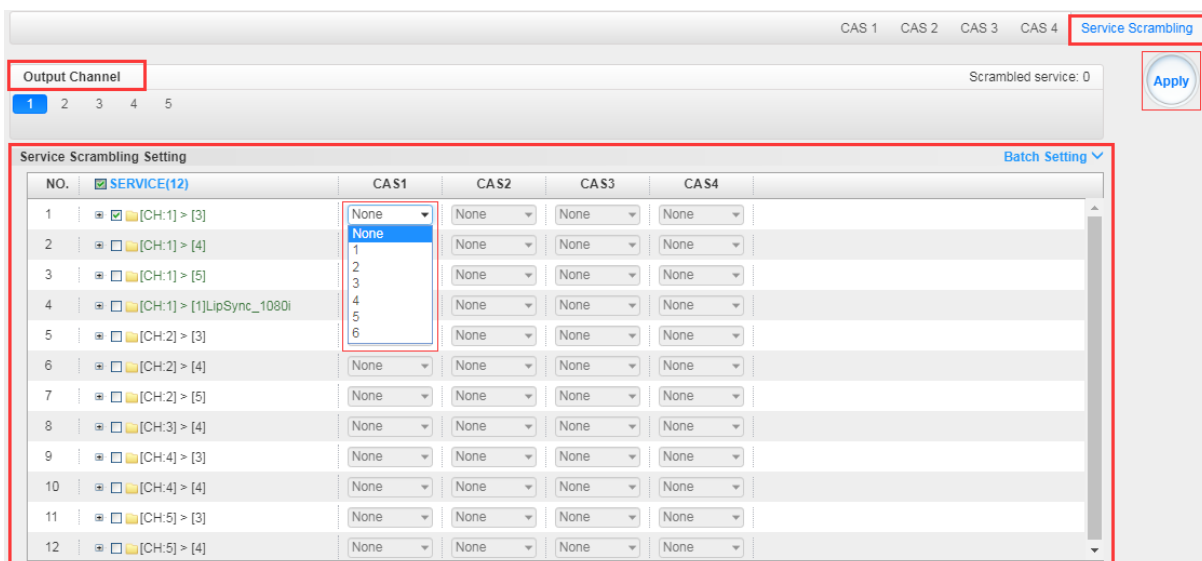

The Modulation Setting Output Channel will only list the enabled channels but not all 32 channels. If the channels and CA ID to be used are arranged in a chronological order, you can use **Batch Setting** for

faster encryption. This is advisable if you have 10 or more services in a single channel for output. See the image below for reference.

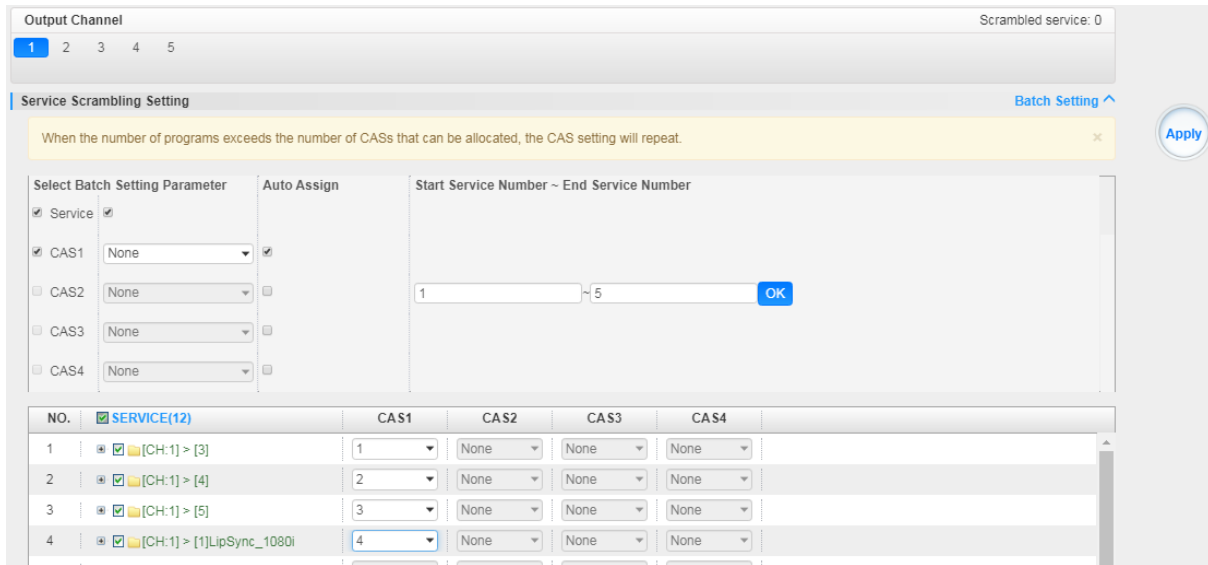

CM2-QAMA-R02 > System

CM2-QAMA-R02 System is composed of two sub menus namely Network and License.

Network> Here you can modify the IP Address, Subnet Mask and Gateway for each port of the module, except for the address of the module itself. This also shows the MAC Address of each port of the module. See the image below for reference.

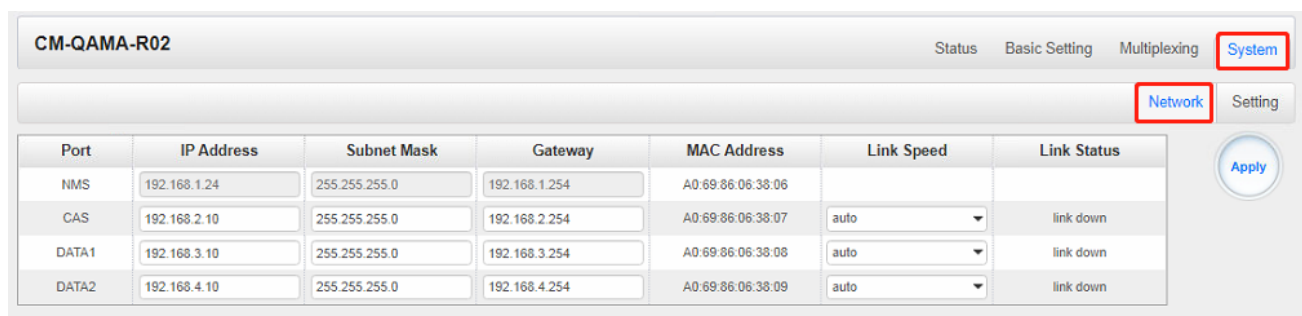



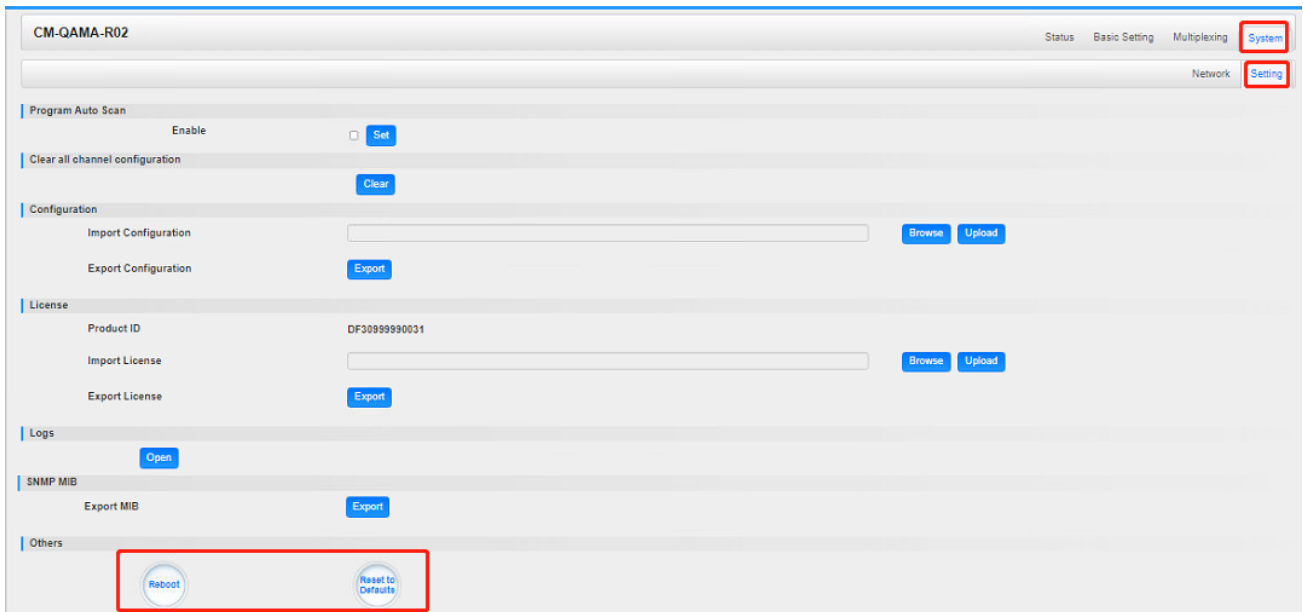

License> Here you can import/export *license*, reboot module, *restore factory default settings* and *manage logs*.

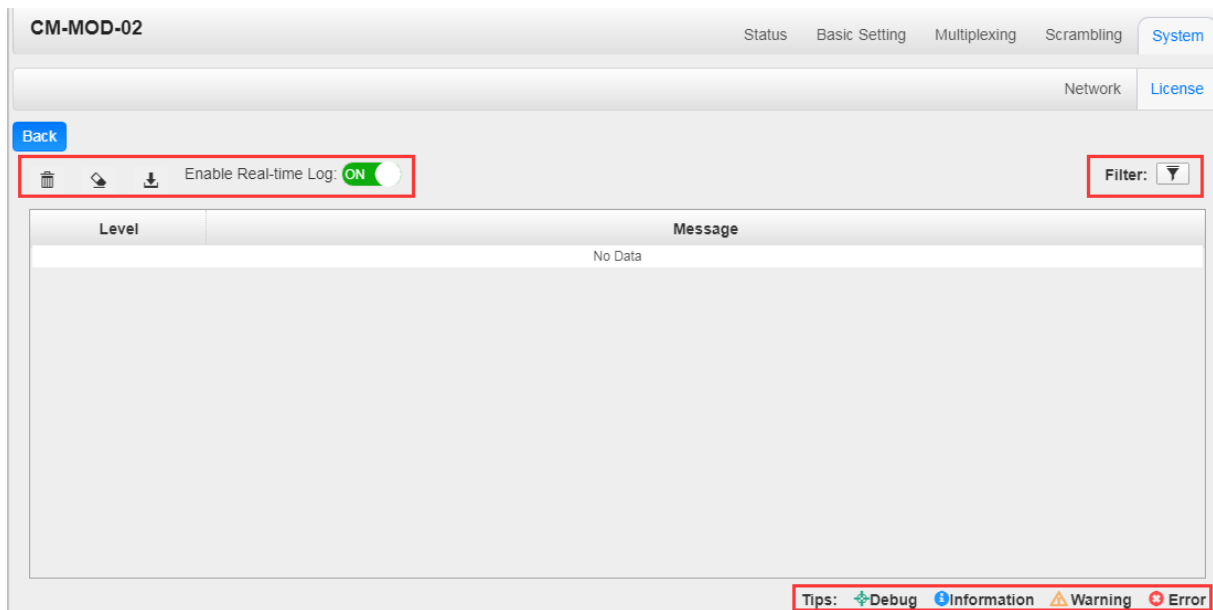

Log Manage>This page shows the logs of the module. If there are issues encountered on this module, exporting the logs will help R&D team to analyze and fix them.

Turn on **Enable Real-time Log** switch to see the real time log messages and the severity level of each message below.



- Click  to clear all log messages on the screen.
- Click  to delete all log information.
- Click  to export log information.

- Click  to filter desired log messages.

Clicking the filter icon, you can simply select what logs to be included.

Log Filter

Level	
Level	Operation
Error	<input checked="" type="checkbox"/>
Warning	<input checked="" type="checkbox"/>
Information	<input checked="" type="checkbox"/>
Debug	<input type="checkbox"/>

Module List	
Module Name	Operation
SYS	<input checked="" type="checkbox"/>
PARAMS	<input checked="" type="checkbox"/>
UPGRADE	<input checked="" type="checkbox"/>
TSPROCESS	<input checked="" type="checkbox"/>
SIPROCESS	<input checked="" type="checkbox"/>
LICENSE	<input checked="" type="checkbox"/>

- CM2-QAMA-02 is as same as CM2-QAMB-02, In addition to supporting the scrambling function, it is not a default authorization and requires additional authorization

5.3.10 CM2-QAMA-R01/R01A

CM2-QAMA-R01 / R01A module supports modulating 4/8 adjacent channels with 1 RF female port for modulating output.



CM2-QAMA-R01>Basic Setting

CM2-QAMA-R01 Status **Basic Setting** Output System

RF Level: (dBmV dBuV) PSI/SI Interval(ms):

Channel	Enable	Frequency(KHz)	QAM Mode	SymbolRate(KBaud)	Bandwidth(MHz)
1.1	<input type="checkbox"/>	<input type="text" value="474000"/>	<input type="text" value="QAM64"/>	<input type="text" value="5185"/>	<input type="text" value="6"/>
1.2	<input type="checkbox"/>	<input type="text" value="482000"/>	<input type="text" value="QAM64"/>	<input type="text" value="5185"/>	<input type="text" value="6"/>
1.3	<input type="checkbox"/>	<input type="text" value="490000"/>	<input type="text" value="QAM64"/>	<input type="text" value="5185"/>	<input type="text" value="6"/>
1.4	<input type="checkbox"/>	<input type="text" value="498000"/>	<input type="text" value="QAM64"/>	<input type="text" value="5185"/>	<input type="text" value="6"/>

[Apply](#)

Click the **Apply** button on the right side to make the change take effect.

Name	Range	Name	Range
Symbol Rate (KBaud)	3780~6956	PSI/SI Interval (ms)	50~10000
RF level	25~45dBmV/85~105dB μ V	Frequency (KHz)	47000~862000
QAM Mode	QAM16/32/64/128/256		

CM2-QAMA- R01/R01A>Output

QAM Output will be different from the Receiver and Encoder module. Since the QAM module is an output module like IP output, all service configured in receiver, encoder and IP input will be seen here.

- TS setting: Please refer to IP output service configuration.

- LCN setting: You need to add NIT streams of all frequencies in the base TS (frequency), which is used for your STB to automatically search and identify all the TS (frequencies) LCN information.
 - Check or reset Original Network ID and TS ID of each TS (frequency). Each TS should have different IDs.
 - Fill the Original Network ID and TS ID of each TS (frequency) in the field of the base TS (frequency) and then click **Add** to create a NIT stream for this TS (frequency).
 - Click **+Descriptor** then LCN Descriptor to check all the programs which are contained in this frequency. Then set programs LCN.

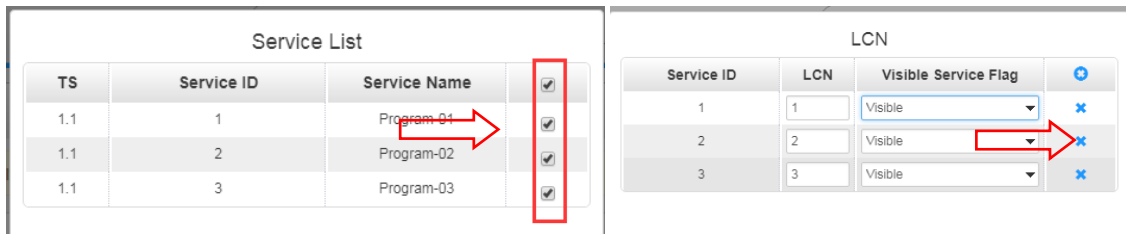
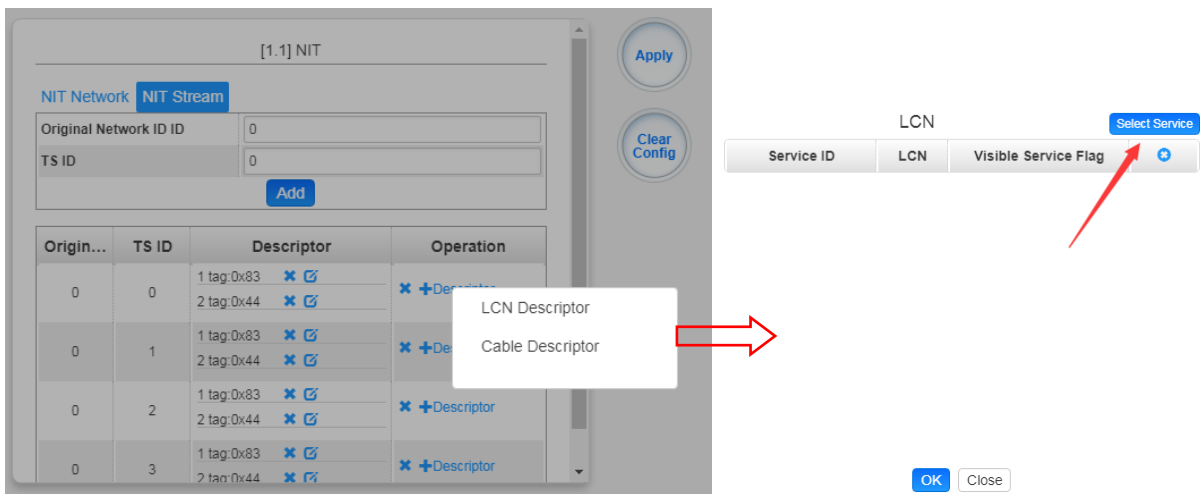

- Click **+Descriptor** and **Cable Descriptor**. Then fill in the correct frequency and symbol rate and choose the correct constellation of the TS (frequency). Then click **OK** (this operation should be set on Modulator module only).

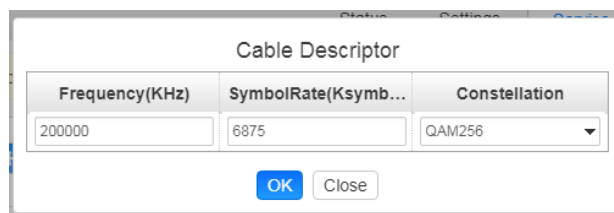

- Repeat the operations to add next TS (frequency) until NIT streams of all the frequencies have been included. Finally click **Apply** to let all configuration take effect. Then searching programs in your STB, you will get all programs in the order of LCN you set.

5.3.11 CM2-8VSB-R01/R01A

CM2-8VSB-R01 / R01A module supports up to 4/8 8VSB adjacent frequencies modulating with 1 RF connector for output.

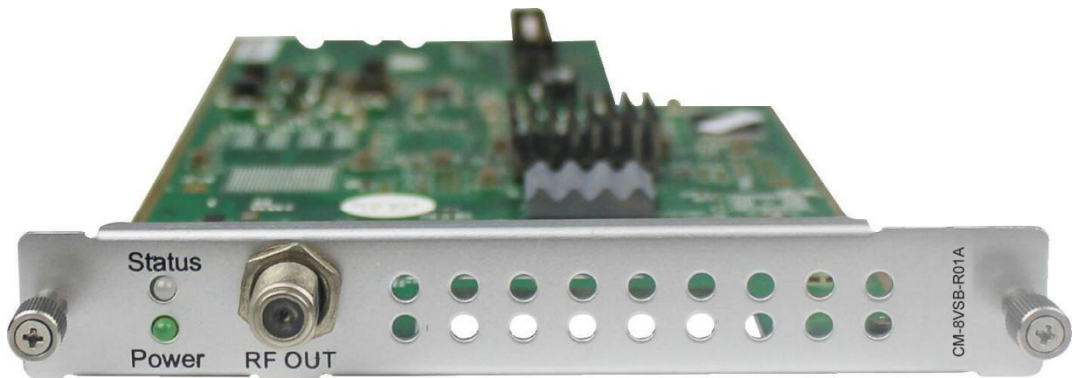

Module configuration is similar to IP Setting.

CM2-8VSB-R01>Basic Setting

CM2-8VSB-R01 Status **Basic Setting** Output System

RF Level: 40 (dBmV dBuV) PSI/SI Interval(ms): 100 Channel Standard: OFF-AIR

Channel	Enable	Frequency
1.1	<input type="checkbox"/>	CH2-57MHz <input type="button" value="v"/>
1.2	<input type="checkbox"/>	CH2-57MHz <input type="button" value="v"/>
1.3	<input type="checkbox"/>	CH2-57MHz <input type="button" value="v"/>
1.4	<input type="checkbox"/>	CH2-57MHz <input type="button" value="v"/>

Click the **Apply** button on the right side to make the change take effect.

Name	Range	Name	Range
RF level (1=0.5dB)	15~48	PSI/SI Interval (ms)	50~10000

Channel Standard	Frequency (KHz)
OFF-AIR	CH2-57MHz
STD	~
IRC	CH69-802MHz
SRC	

CM2-8VSB-R01/R01A >Output

- TS setting: Please refer to IP output service configuration.
- To use this board,you need to change the **Standard** to ATSC in **Advance Settings-System Settings**.
- Don't forget to click **APPLY** when you finish configuration.

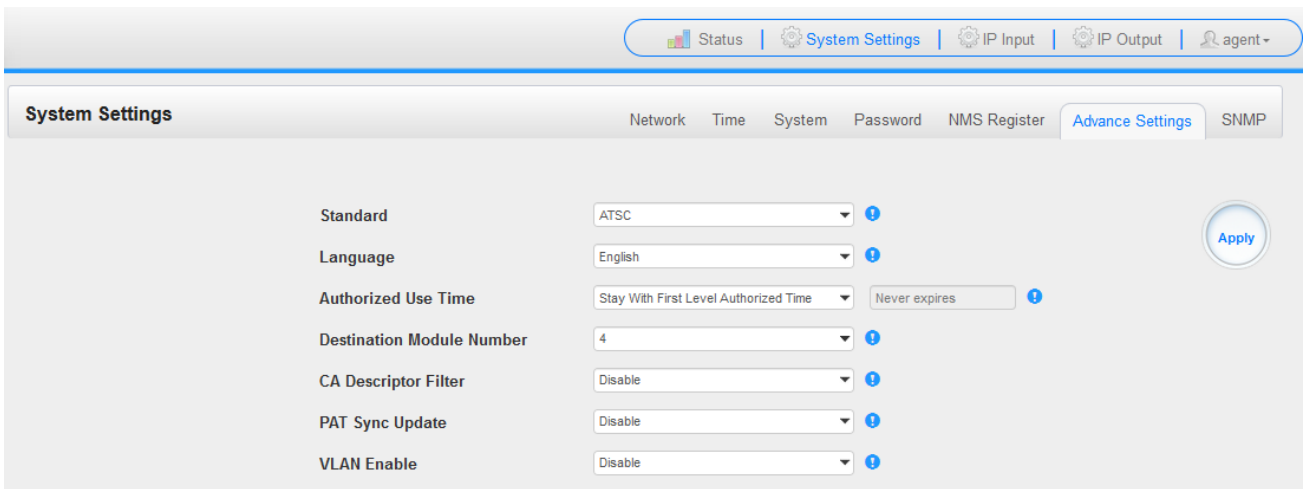

5.3.12 CM2-QAMB-R01/R01A



CM2-QAMB-R01 / R01A module supports up to 4/8 adjacent frequencies modulating with 1 RF female connector for output.

Module configuration is similar to IP Setting.

CM2-QAMB-R01/R01A>Basic Setting

CM2-QAMB-R01 Status **Basic Setting** Output System

RF Level: (dBmV dBuV) PSI/SI Interval(ms): Channel Standard:

Channel	Enable	Frequency	QAM Mode	SymbolRate(KBaud)
1.1	<input type="checkbox"/>	CH2-57MHz	QAM256	5361
1.2	<input type="checkbox"/>	CH2-57MHz	QAM256	5361
1.3	<input type="checkbox"/>	CH2-57MHz	QAM256	5361
1.4	<input type="checkbox"/>	CH2-57MHz	QAM256	5361

Click the **Apply** button on the right side to make the change take effect.

Name	Range	Name	Range
Symbol Rate (KBaud)	5057 (QAM64) 5361 (QAM256)	PSI/SI Interval (ms)	50~10000
RF level	25~45dBmV/85~105dB μ V	Frequency (KHz)	48000~862000
QAM Mode	QAM64/256		

CM2-QAMB-R01>Service Configuration

- TS setting: Please refer to IP output service configuration.
- LCN setting: You need to add NIT streams of all frequencies to the base TS (frequency), which is for your STB to automatically search and identify all the TS (frequencies) LCN information.
 - Check or reset Original Network ID and TS ID of each TS (frequency)., Each TS should have different IDs.
 - Fill the Original Network ID and TS ID of each TS (frequency) in the field of the base TS (frequency) and then click **Add** to create a NIT stream for this TS (frequency).
 - Click **+Descriptor** then **LCN Descriptor** to check all the programs which are contained in this frequency. Then set programs LCN.

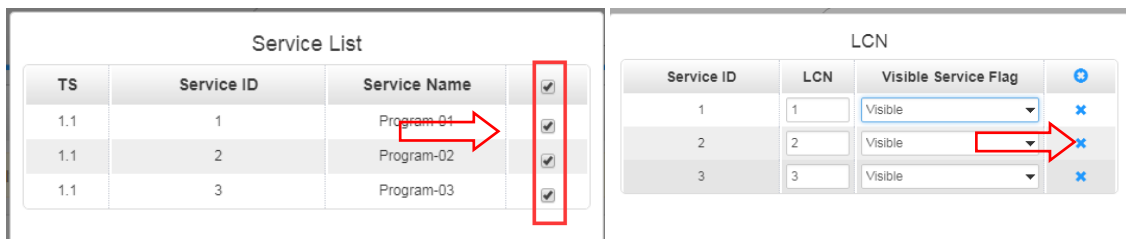
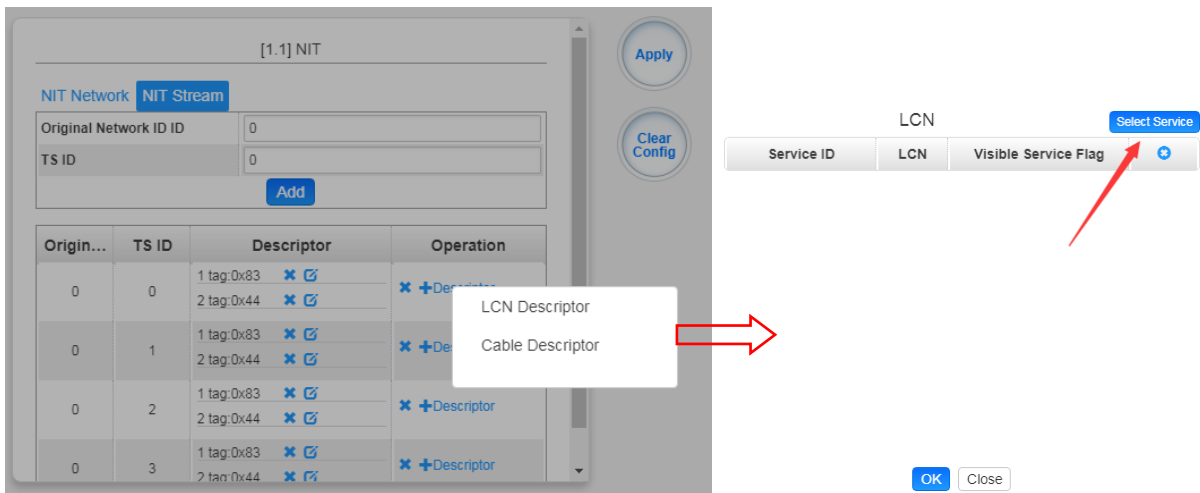

- Click **+Descriptor** and **the Cable Descriptor**. Then fill in the correct frequency and symbol rate and choose the correct constellation of the TS (frequency). Then click **OK**. (This operation should be set on Modulator module only).

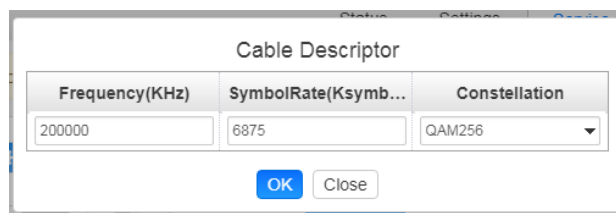

- Repeat the operations to add next TS (frequency) until NIT streams of all the frequencies have been included. Finally click **Apply** button to let all configuration take effect. Then searching programs in your STB, you will get all programs in the order of LCN which you set.

5.3.13 CM2-OFDM-R01/R01A

CM2-OFDM-R01 / R01A module supports up to 4/8 adjacent frequencies modulating with 1 RF female connector for output.



Module configuration is similar to IP Setting.

CM2-OFDM-R01>Basic Setting

CM2-OFDM-R01 Status **Basic Setting** Output System

RF Level: (dBmV dBuV)

Channel	Enable	Frequency(KHz)	Bandwidth(MHz)	FFT Mode	GI Mode	QAM Mode	Convolutional Coding
1.1	<input type="checkbox"/>	<input type="text" value="474000"/>	<input type="text" value="6"/>	<input type="text" value="2K"/>	<input type="text" value="1/32"/>	<input type="text" value="64QAM"/>	<input type="text" value="7/8"/>
1.2	<input type="checkbox"/>	<input type="text" value="482000"/>	<input type="text" value="6"/>	<input type="text" value="2K"/>	<input type="text" value="1/32"/>	<input type="text" value="64QAM"/>	<input type="text" value="7/8"/>
1.3	<input type="checkbox"/>	<input type="text" value="490000"/>	<input type="text" value="6"/>	<input type="text" value="2K"/>	<input type="text" value="1/32"/>	<input type="text" value="64QAM"/>	<input type="text" value="7/8"/>
1.4	<input type="checkbox"/>	<input type="text" value="498000"/>	<input type="text" value="6"/>	<input type="text" value="2K"/>	<input type="text" value="1/32"/>	<input type="text" value="64QAM"/>	<input type="text" value="7/8"/>

Click the **Apply** button on the right side to make the change take effect.

Name	Range	Name	Range
------	-------	------	-------

Bandwidth	6M, 7M, 8M	RF level	0-31.5dBmv/60-91.5dB μ v
Frequency (KHz)	48000~862000		

CM2-OFDM-R01A>Output

- TS setting: Please refer to IP output configuration.
- LCN setting: You need to add NIT stream of all frequencies in the base TS (frequency) which is used for your STB auto search and identifies all the TS (frequencies) LCN information.
 - Check or reset Original Network ID and TS ID of each TS (frequency). Each TS should have different IDs.
 - Fill the Original Network ID and TS ID of each TS (frequency) in the field of the base TS (frequency) and then click **Add** to create a NIT stream for this TS (frequency).
 - Click **+Descriptor** and **Cable Descriptor**. Then fill in the correct frequency and symbol rate and choose the correct constellation of the TS (frequency) and then click **OK** (this operation should be set on Modulator module only).

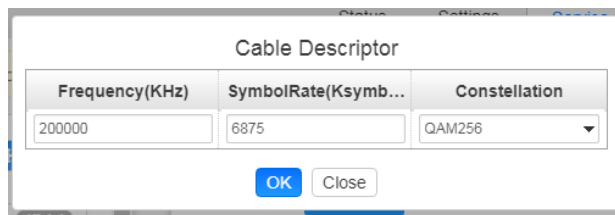

- Click **+Descriptor** and add the **LCN Descriptor** to check all the programs which are contained in this frequency. Then set programs LCN.

Origin...	TS ID	Descriptor	Operation
0	0	1 tag:0x83	✕ +Descriptor
		2 tag:0x44	✕ +Descriptor
0	1	1 tag:0x83	✕ +Descriptor
		2 tag:0x44	✕ +Descriptor
0	2	1 tag:0x83	✕ +Descriptor
		2 tag:0x44	✕ +Descriptor
0	3	1 tag:0x83	✕ +Descriptor
		2 tag:0x44	✕ +Descriptor

Service List

TS	Service ID	Service Name	<input type="checkbox"/>
1.1	1	2.5M-CCTV1	<input checked="" type="checkbox"/>
1.2	1	Program0	<input type="checkbox"/>
1.3	1	LipSync_1080i	<input type="checkbox"/>
1.3	2	td HD Phx Chinese Cha...	<input type="checkbox"/>

LCN Select Service

Service ID	LCN	Visible Service Flag	<input type="button" value="+"/>
1	66	Visible	<input type="button" value="x"/>

- Repeat the operations to add next TS (frequency) until NIT streams of all the frequencies have been included. Finally click Apply button to let all configuration take effect. Then searching programs in your STB, you will get all programs in the order of LCN which you set.

5.3.14 CM2-ISDBT-R01/R01A

CM2-ISDBT-R01/R01A module supports up to 4/8 adjacent frequencies modulating with 1 RF female connector for output.

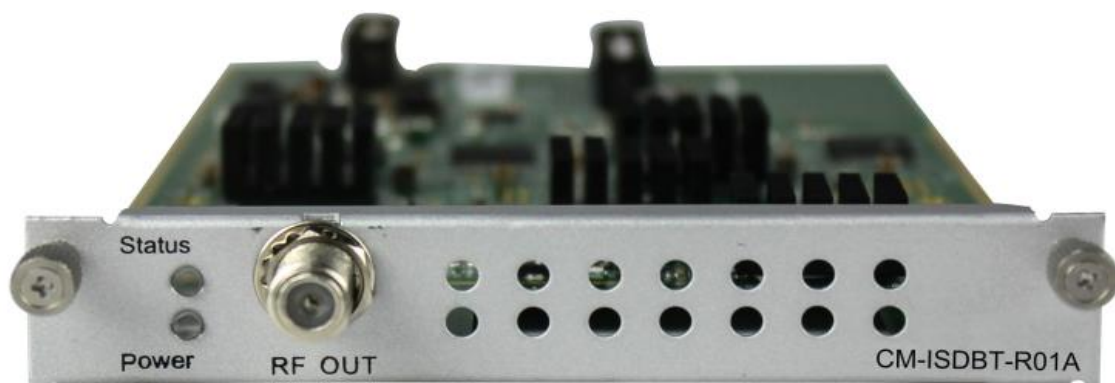

CM2-ISDBT-R01>Basic Setting

Click the **Apply** button on the right side to make the change take effect.

Name	Range	Name	Range
Bandwidth(MHZ)	6M	RF level	25~45dBmV/85~105dB μ V
Frequency (KHz)	48000~862000	FFT Mode	2K
GI Mode	1/4, 1/8, 1/16, 1/32	RF Level Gain(dB)	45~55
QAM Mode	QPSK	Convolutional	1/2, 2/3, 3/4, 5/6, 7/8
	16QAM	Coding	
	64QAM		

CM2-ISDBT-R01/R01A>Output

- TS setting: Please refer to IP output service configuration.
- LCN setting: You need to add NIT streams of all frequencies to the base TS (frequency) which is for your STB to automatically search and identify all the TS (frequencies) LCN information.
 - Check or reset Original Network ID and TS ID of each TS (frequency). Each TS should have different IDs.
 - Fill the Original Network ID and TS ID of each TS (frequency) in the field of the base TS (frequency) and then click **Add** to create a NIT stream for this TS (frequency).
 - Click **+Descriptor** and **Cable Descriptor**. Fill in the correct frequency and symbol rate and choose the correct constellation of the TS (frequency) and then click OK (this operation should be set on Modulator module only).

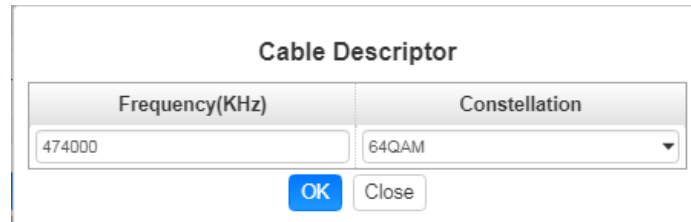

- Click **+Descriptor** and **LCN Descriptor** to check all the programs which are contained in this frequency. Then set programs LCN.

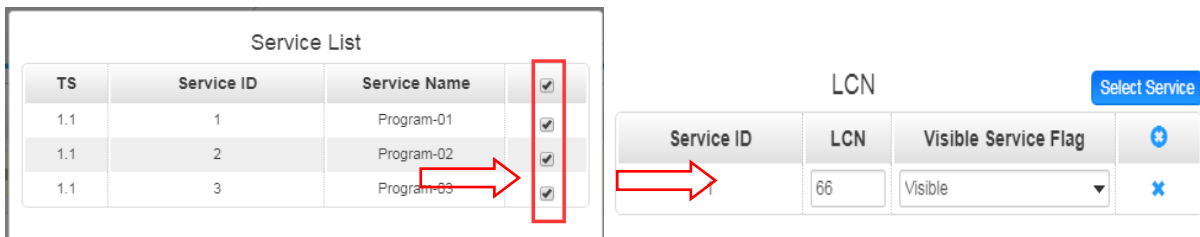
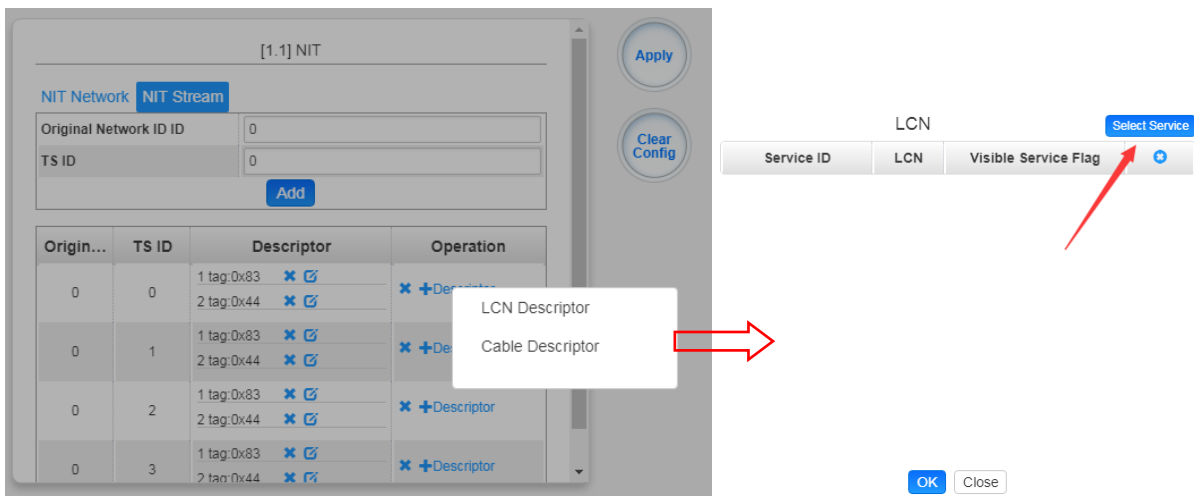

- Repeat the operations to add next TS (frequency) until NIT streams of all the frequencies have been included. Finally click Apply button to let all configuration take effect. Then searching programs in your STB, you will get all programs in the order of LCN you set.

5.4 Function modules

5.4.1 CP2-EAS-00

CP2-EAS-00 module provides the ability to interrupt Encoder playback and switch to an external transport stream. This feature is for the US market and requires the CMP201A chassis to be set for ATSC standard. A common application of Emergency Alert Systems is for Broadcast and Audio Muting.

The trigger switched video content on the Encoders can be sensed using a DC contact closure or the SCTE-18 EAS standard over ASI/IP when the EAS is “Paved” or actively replacing the encoder outputs.



CP2-EAS-00>Basic Setting

EAS Source Setting ▼

EAS Signal Input:	<input type="text" value="Analogue(Relay)"/>
EAS Program Input:	<input type="text" value="ASI"/>
Trigger Mode:	<input type="text" value="Normally Open"/>

Command Input Setting ▼

PID:	<input type="text" value="1"/>
IP Address:	<input type="text" value="192.1.1.100"/>
IP Port :	<input type="text" value="5050"/>

Encoder Setting ▼

Video Type:	<input type="text" value="Mpeg-2"/>
Audio Type:	<input type="text" value="Mpeg4-AAC"/>
Video Bitrate (Kbps):	<input type="text" value="5000"/>
Audio Bitrate (Kbps):	<input type="text" value="320"/>
Volume:	<input type="text" value="10"/>

IP Output Setting ▼

! Note: Don't take up the UDP multicast address,avoid the IP conflict.If you want to modify them ,you need to modify other subboards synchronously.

Editable:	<input type="text" value="Enable"/>
IP Address:	<input type="text" value="227.10.50.60"/>
Command Port:	<input type="text" value="1235"/>
Data Port:	<input type="text" value="1234"/>

Click the **Apply** button on the right side to make the change take effect.

Name	Range	Name	Range
------	-------	------	-------

Command Input Setting

EAS Signal Input	Digital(IP)	EAS Program Input	ASI
	Analogue(Dry Contact)		AV

	Analogue(Relay)		
Trigger Mode	Normally Open		
	Normally Closed		
Encoder Setting			
Video Type	H.264, MPEG-2	Audio Type	AC3, Mpeg-1 Layer 2 Mpeg2-AAC, Mpeg4-AAC
Video Bit rate(Kbps)	1500~20000	Audio Bit rate(Kbps)	128, 192, 256, 384
Volume	-10~10		

When you set the IP output of the EAS module, you should set the same parameters for other modules that the service(s) will be paved by EAS input (ASI or AV signal). Then the EAS module will be detected automatically by other modules to complete more configuration. When it is triggered by external IP or analogue (Dry Contact) signals, the configured services(s) on other modules will be switched to the AV or ASI services from EAS module.

CP2-EAS-00>Status

EAS Status	
EAS Status:	Unlocked
AV Input	
Video Resolution:	No Video
Encoder Status	
Total Bitrate:	0.000 Mbps
Effective Bitrate:	0.000 Mbps
Video Resolution:	No Video
ASI Input	
Signal Lock:	Unlocked
Total Bitrate:	0.000 Mbps
Effective Bitrate:	0.000 Mbps
Program Scan Status:	Abnormal
IP Output	
Total Bitrate:	0.000 Mbps
Video Bitrate:	0.000 Mbps
Audio Bitrate:	0.000 Mbps
Effective Bitrate:	0.000 Mbps
Version Info	
Firmware Version:	V0.3.0
Software Version:	V1.4.3
Hardware Version:	V0.0.0

5.4.2 CP2-CAM-00

CP2-CAM-00 is a scrambling & descrambling module with 2 CI slots. It supports almost all kinds of CAM card descrambling and the number of descrambled services is defined by the CAM card. It supports descrambling services which are multiplexed from different IP/RF channels or modules. The scrambling function is designed for specific users. Currently the module only supports Xcrypt CAMCAS scrambling.



CP2-CAM-00 >Status

Status shows the total bitrate and effective bitrate of each channel. It also supports TS analysis and service list.

CP2-CAM-00				
Status CI Service Configuration System				
Channel	Total Bitrate(Mbps)	Effective Bitrate(Mbps)	TS Analysis	Service List
1.1	0.000	0.000		
1.2	0.045	0.045		

Click the icon () below the **TS Analysis** to see the TS analyzing result of this channel. Click the icon () below the **Service List** to see the Services of this channel.

- **TS Analysis**

Click **Reset Counter** to clear continuity count error and restart counting. Fill the key words of PID, bitrate, bandwidth, table type or service name in the search bar to check the info you wanted.

Channel 1.1 TS Analysis					
Reset Counter					
Search					
PID	Bitrate(Mbps)	Bandwidth(%)	Continuity Count Error	Type	Service
0x0(0)	0.058	0.150	0	PAT	
0x10(16)	0.000	0.000	0	Other	
0x11(17)	0.003	0.008	0	SDT	
0x12(18)	0.379	0.978	0	Other	
0x14(20)	0.000	0.000	0	Other	
0x424(1060)	3.793	9.788	0	PCR, Video	Russia Today
0x425(1061)	0.198	0.511	0	Audio	Russia Today

Tips:

- **Service List**

Click the service name to check the detail info of this service.

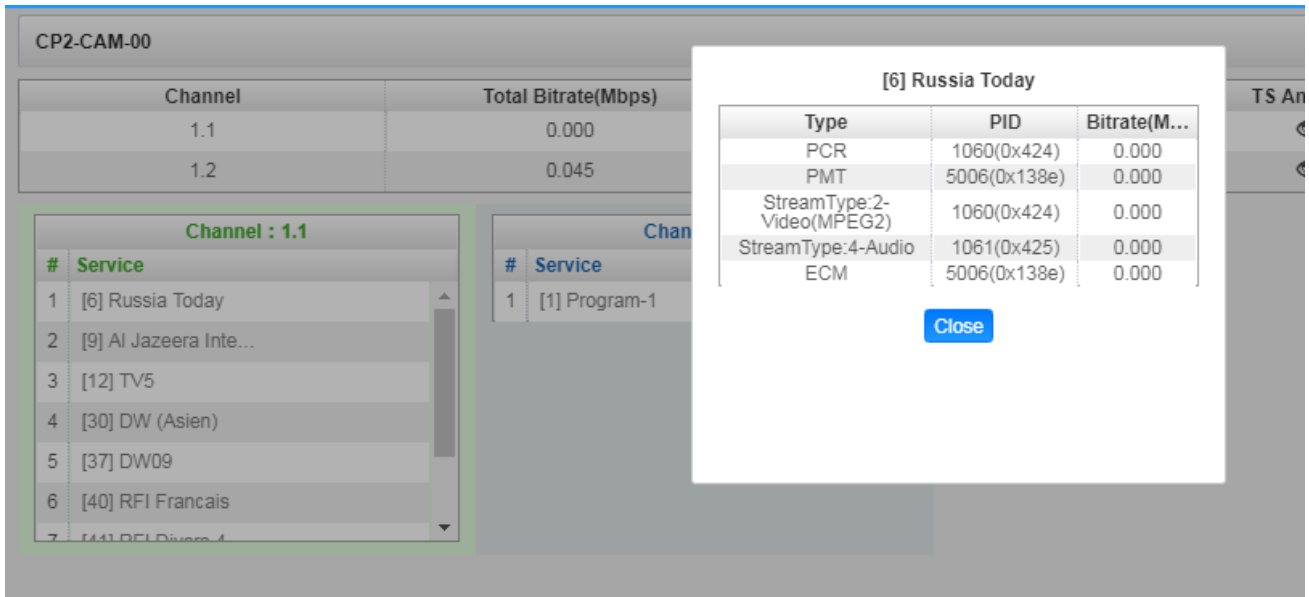

CP2-CAM-00 >CI

CI page not only shows the CAM card name and CA system ID, but also shows the service PID, service information and scrambling/descrambling status.

CAM Max Bitrate is from 48Mbps to 108Mbps, which you can choose in the pull-down list.

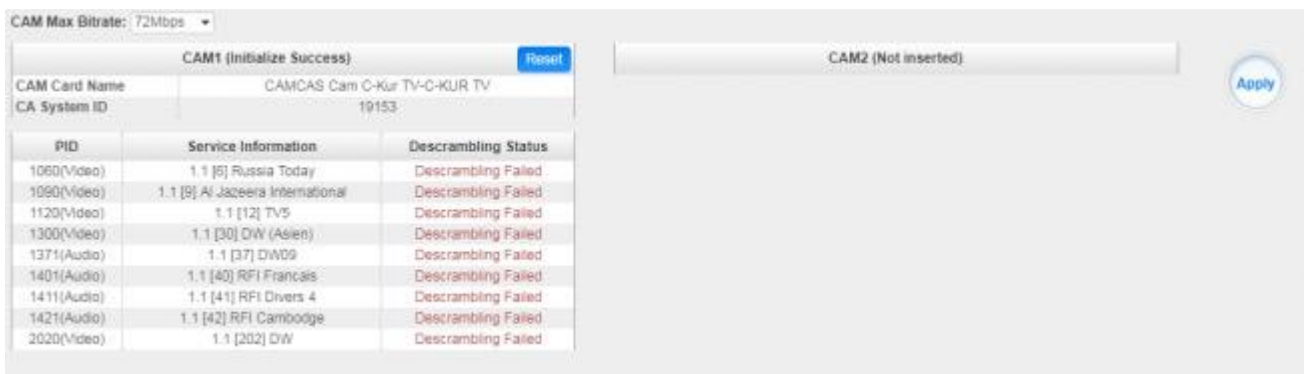
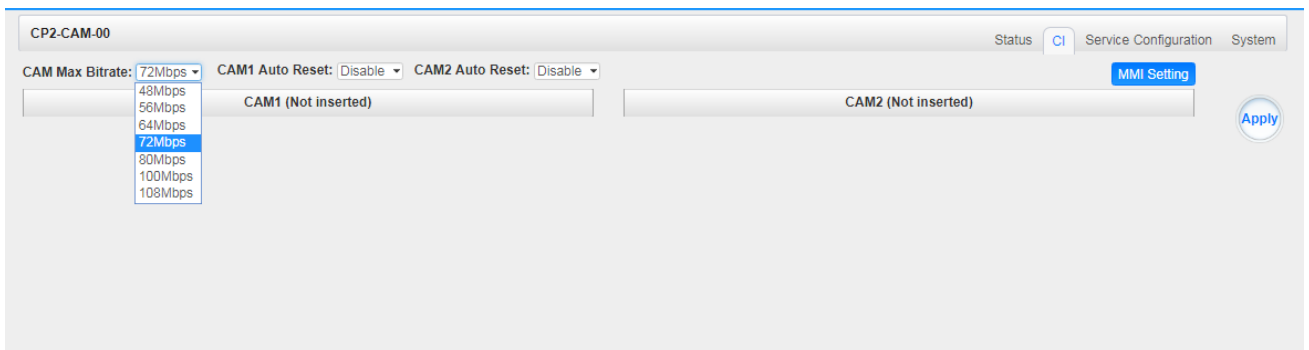

Click **Reset** to reboot the CAM card. Click **Apply** on the right side to make the change take effect.

CP2-CAM-00 >Service Configuration

When this module is licensed to scramble, on this page, you can set the output destination of all services.

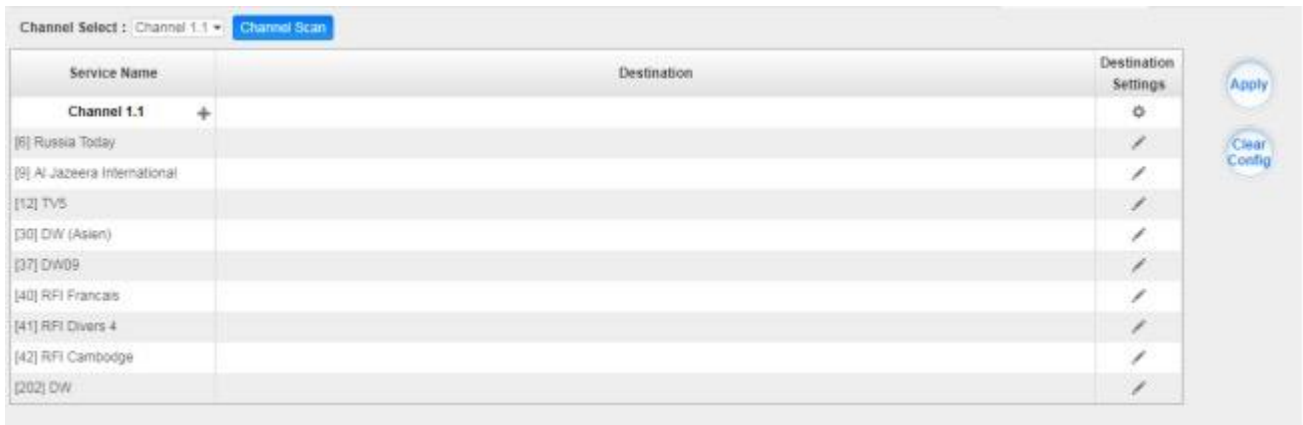

When this module is licensed to descramble, on this page, you can select the descrambled services and set the output destination of all services.

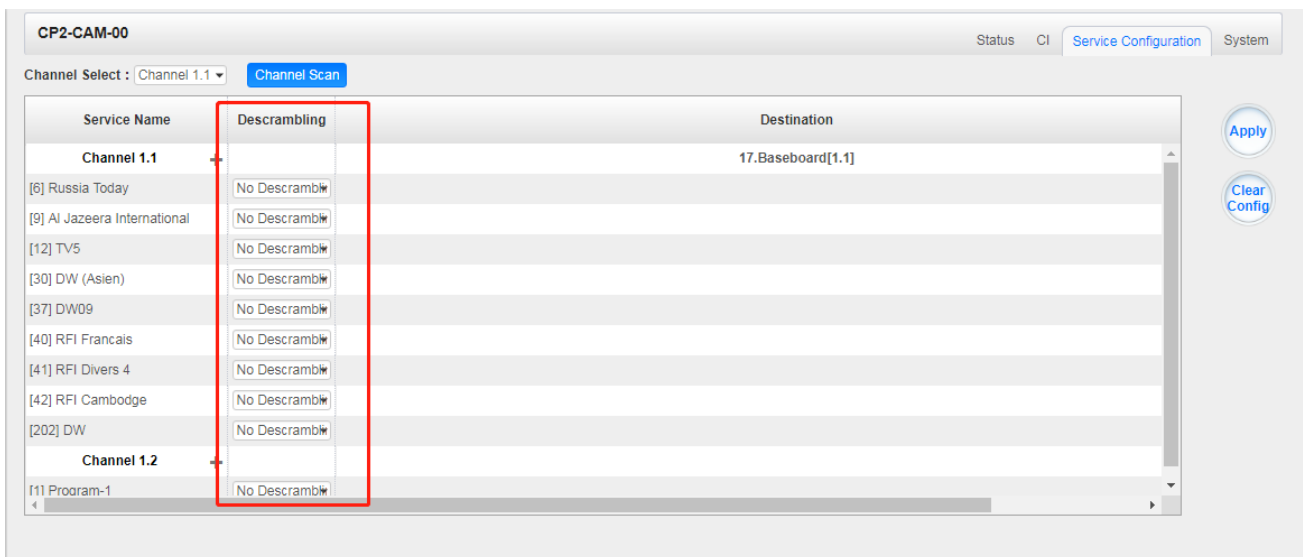

Click **Apply** on the right side to make the change take effect. Click **Clear Configuration** to clear all configurations.

CP2-CAM-00 >System

When this module is licensed to scramble, it has the functions of scrambling and descrambling. Change the **CAM Mode** through pull-down list. Click **Apply** to save the change.



When this module is licensed to descramble, it only can be served as descrambling.





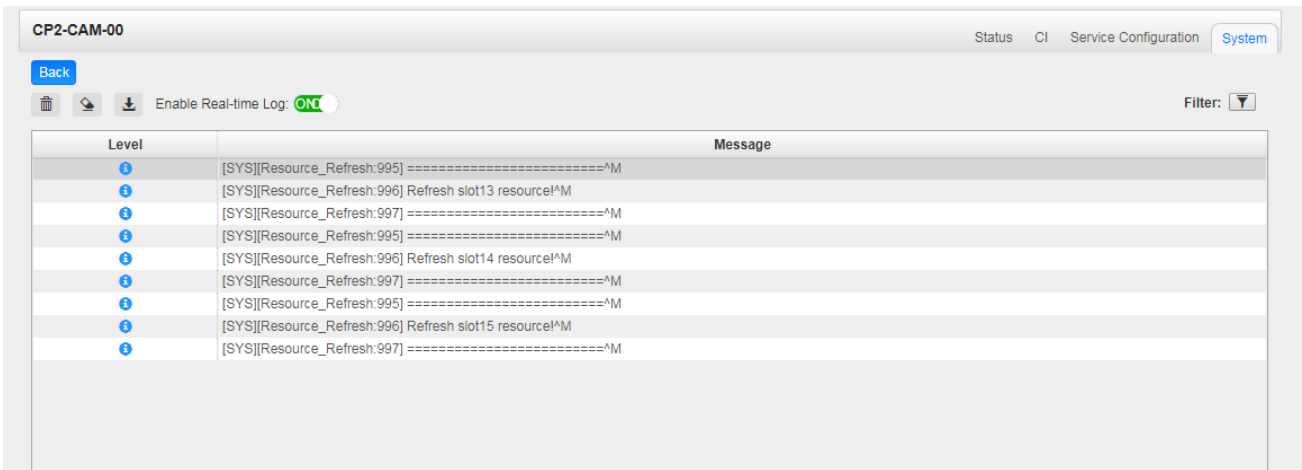

On **System Operation** page you can **Import/Export** License, **Reboot** module, **Factory Reset** and **Manage logs**.

- **Log Manage**

Turn on **Enable Real-time Log** switch to see the real time log message and level below.



- Click  to clear all log messages on the screen.
- Click  to delete all log information.
- Click  to export log information.
- Click  to filter desired log message.

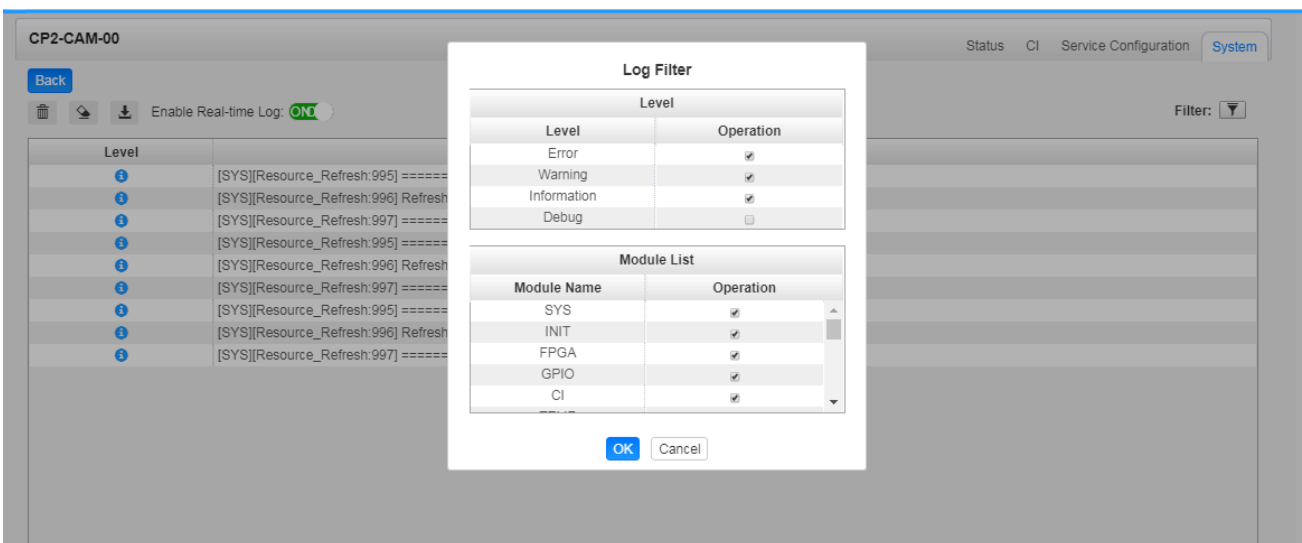

5.4.3 CP2-EIT-00

CP2-EIT-00 is an EIT multiplex module. It supports up to 32 TS inputs and up to 16 TS outputs. It also supports EIT multiplexing enable control at module level, TS level and program level. Multiple EIT multiplexing modules can run simultaneously in a single chassis.

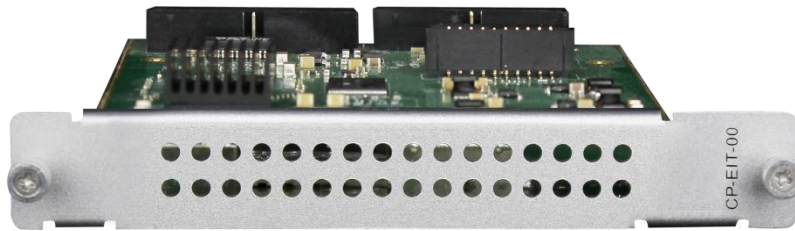

The GUI of EIT module includes three pages: **Status**, **Module Setting** and **System**.

CP2-EIT-00 >Status

The Status Page displays modules and services with EIT enabled. The indicator in front of each service shows its working status.

Green: EIT is enabled and normal.

Red: EIT is enabled but abnormal. No EIT content from the source or no EIT output.

Gray: EIT is disabled.

CP-EIT-00					
		Status Module Setting System			
EIT Enabled Module		Channel	Service Name	Service ID	Source
4 CM-QAMA-01		CH1	● CNN	32→302	Slot 6: CR-DVBS2CI-00
5 CM-QAMB-01		CH2	● Bloomberg ● BBC World	56→303 1→55	Slot 6: CR-DVBS2CI-00 Slot 6: CR-DVBS2CI-00
		CH3	● Animal Planet	123→309	Slot 6: CR-DVBS2CI-00
		CH4	● EuroSports ● CNN ● American idol	12→19 672→77 65→68	Slot 6: CR-DVBS2CI-00 Slot 6: CR-DVBS2CI-00 Slot 6: CR-DVBS2CI-00

CP2-EIT-00 >Settings

The screenshot displays the configuration page for CP2-EIT-00. It features a navigation bar with 'Status', 'Module Setting', and 'System' tabs. The 'Module Setting' tab is active, showing a table of EIT enabled modules. The table has three columns: 'EIT Enabled Module', 'Baseboard', and a list of modules including '3.CM2-ISDBT-R01A' and '6.CM2-QAMA-R01A'. A checkbox for 'EIT Enable/Disable Control' is located above the table, with a dropdown menu showing '[CH1]'. To the right, a 'Tips' section provides three numbered instructions regarding EIT function defaults, control usage, and checkbox functionality. An 'Apply' button is positioned at the bottom right of the tips section.

Here you can select all modules or click checkbox of the module option which you need to make EIT enabled configuration. EIT function is enabled by default on modulator module and disabled on all IP output channels of baseboard. You can check the detailed information in the Tips tab.

- Supports parsing of EIT table with DVB-S/S2/S2X/C/T/T2, ISDB-T, IP input.
- Supports QAM-A/OFDM/IP output EIT table.

Click **Apply** button on the right side to make the changes made take effect.

When there is a CP2-EIT-00 module, you should still start the configuration from receiving modules and output the required services to modulation module or IP output of baseboard, since the EIT module will utilize the created service list to generate a new EIT table accordingly. Here is an example of CR2-DVBS2CI-00 DVB-S/S2 receiver module and CM2-QAMA-R01A modulation module as an example.

Select the corresponding modulation module and a channel for each service. The service will be multiplexed automatically on the modulation module.

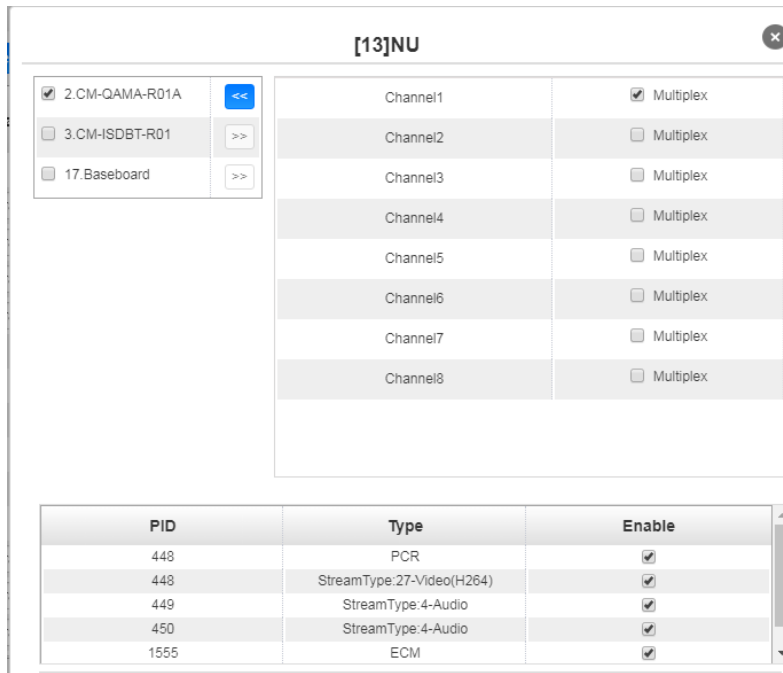

After finish the service configuration, you can go to the EIT module to enable or disable the EIT multiplexing for specific services and check the EIT multiplexing status. EIT function is enabled on modulation module and disabled on IP output of baseboard by default.

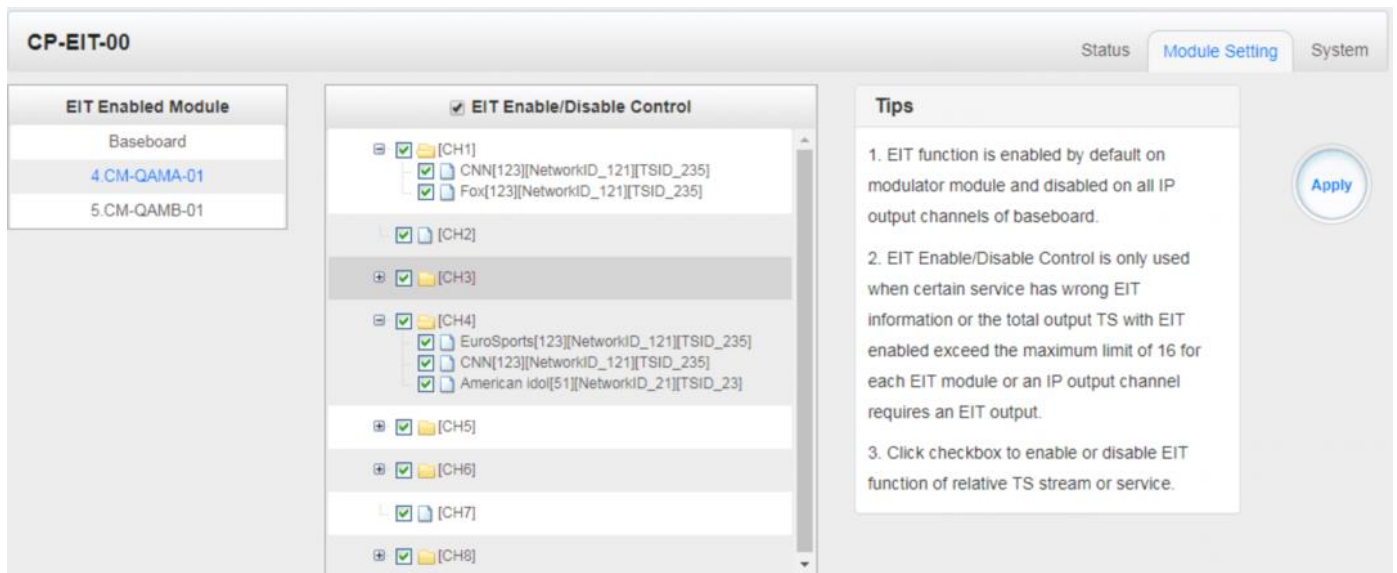

All service lists will be obtained automatically from related modulation modules or IP output channels

CP2-EIT-00 >System



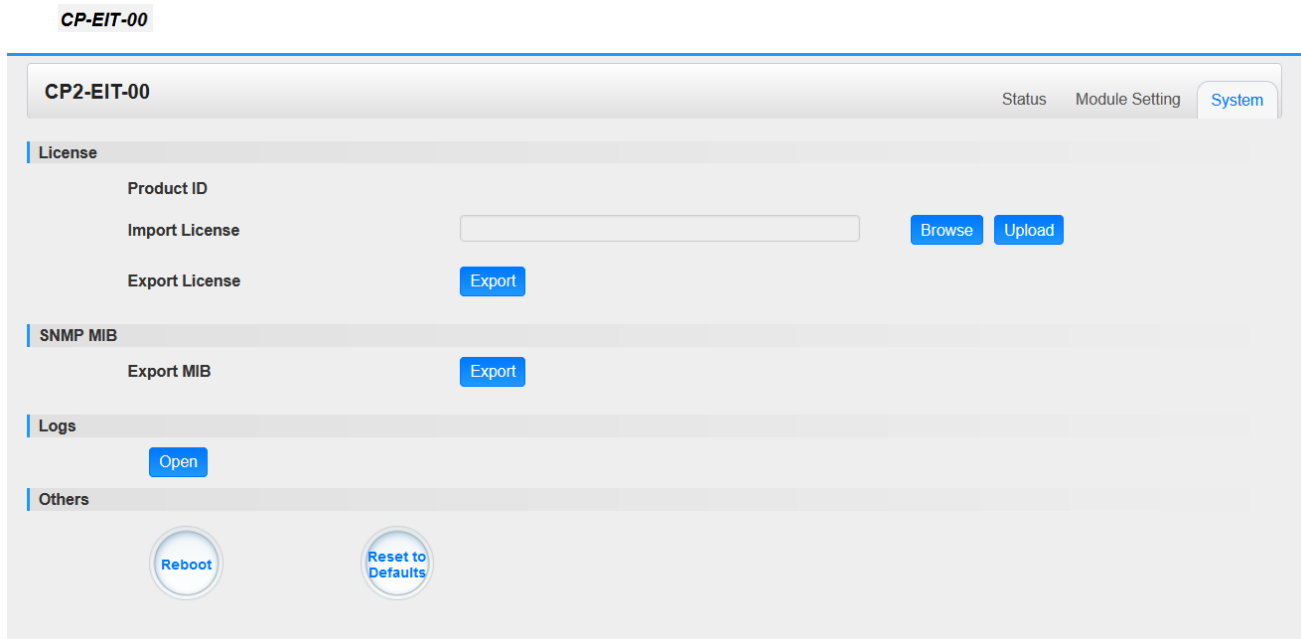

On **System** page you can import/export **license**, reboot module, **restore factory default settings** and **manage logs** for trouble-shooting.

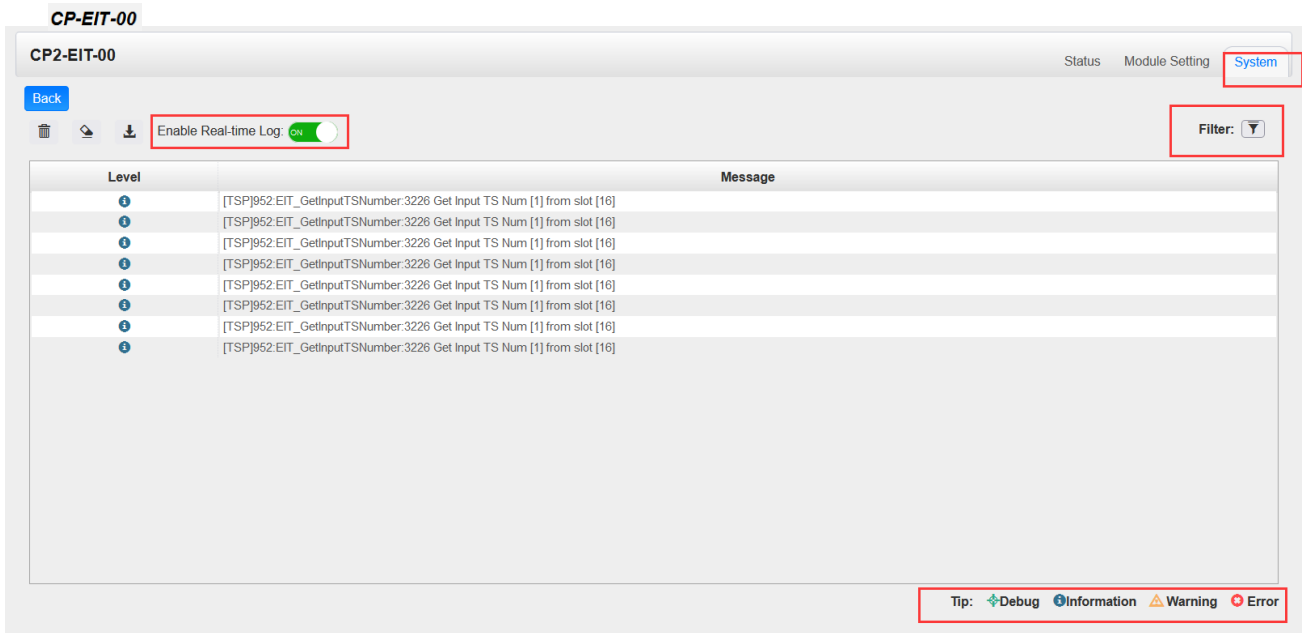

Log Manage>This page shows the logs of the module. If there are issues encountered on this module, exporting the logs will help R&D team to analyze and fix them.

Turn on **Enable Real-time Log** switch to see the real time log messages and the severity level of each message below.



- Click  to clear all log messages on the screen.
- Click  to delete all log information.
- Click  to export log information.
- Click  to filter desired log messages.

Clicking the filter icon, you can simply select what logs to be included.

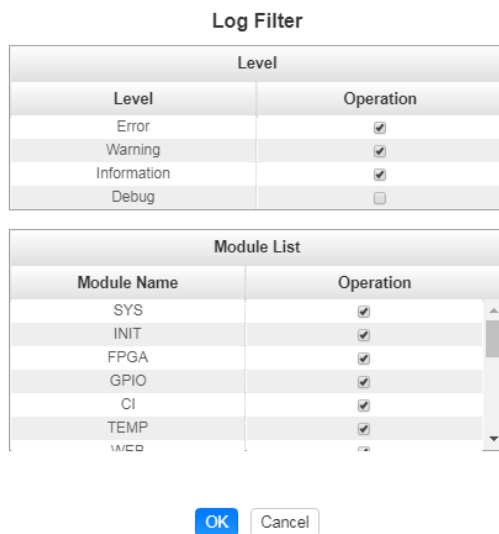

5.4.4 CP2-ASI-00

CP2-ASI-00 module is an ASI module that has 5 bidirectional ASI ports. Each port can be defined as either ASI input port or ASI output port. It supports different TS stream formats of 188/204 bytes packet length and Byte/Packet stream mode with up to 150Mbps TS stream bitrate.



Click **CP2-ASI-00** in the Module List to reach CP2-ASI-00 module page.

CP2-ASI-00 >Status

CP2-ASI-00							
Channel	Input/Output	Locked Status	Effective Bitrate(Mbps)	Total Bitrate(Mbps)	Bitrate	TS Analysis	Service List
1.1	Output	--	3.548	36.000	Normal		
1.2	Output	--	0.000	36.000	Normal		
1.3	Output	--	0.000	36.000	Normal		
1.4	Input	Unlocked	0.000	0.000	--		
1.5	Input	Unlocked	0.000	0.000	--		

Click **TS Analysis** of each channel, you can see TS bitrate Analysis. Click **Reset Counter** to reset the Continuity Count Error counter. In the Search bar, you can input key words or numbers, such as PIDs, Type or Service, for a quick search.

Channel1.1 TS Analysis Reset Counter

Search

PID	Bitrate(Mbps)	Bandwidth(%)	Continuity Count Error	Type	Service
0x0(0)	0.015	0.100	0	PAT	
0x1(1)	0.015	0.100	0	Other	
0x10(16)	0.000	0.000	0	Other	
0x11(17)	0.001	0.007	0	SDT	
0x12(18)	0.001	0.007	0	Other	
0x14(20)	0.000	0.000	0	Other	
0x101(257)	0.015	0.100	0	PMT	LVJ Main
0x102(258)	0.330	2.200	0	Audio	LVJ Main
0x200(512)	13.832	92.213	0	PCR, Video	LVJ Main

Click the icon  to check service information of all the inputs.

Channel : 1.1		Channel : 1.2	
#	Service	#	Service
1	[1] LVJ Main		No Data

You can check program details by clicking the program item.

[1] LVJ Main

Type	PID	Bitrate(Mbps)
PCR	512(0x200)	13.841
PMT	257(0x101)	0.015
StreamType:36-Video(H265)	512(0x200)	13.841
StreamType:15-Audio(MPEG2_AAC)	258(0x102)	0.329

[Close](#)

Channel	Input/Output	Packet Length	Total Bitrate(Mbps)
1.1	Output	188	36
1.2	Output	188	36
1.3	Output	188	36
1.4	Input	--	--
1.5	Input	--	--

Name	Range
Total Bitrate (Mbps)	0.25 - 180
Packet Length	188/204

Click the **Apply** button on the right side to make the change take effect.

CP2-ASI-00 >ASI Input

You can route a whole stream or a service(s) from the input channel toward the available output channels (IP or RF). Two types of routing are available.

To use **Bypass mode**

In this mode, you can route a whole input transport stream towards an IP or RF output which will be occupied only by this stream. Any attempt of routing other stream/service towards this channel will be

an error. This mode can only be set by clicking the icon  on the TS.

To use **Multiplex mode**

This mode allows the administrator to perform the following operations:

1. Route a single service towards an output channel to create SPTS.
2. Route services towards a single output channel to create MPTS.

3. Route service(s) AND stream/s from multiple channels towards a single output channel to create MPTS.

CP2-ASI-00 >ASI Output

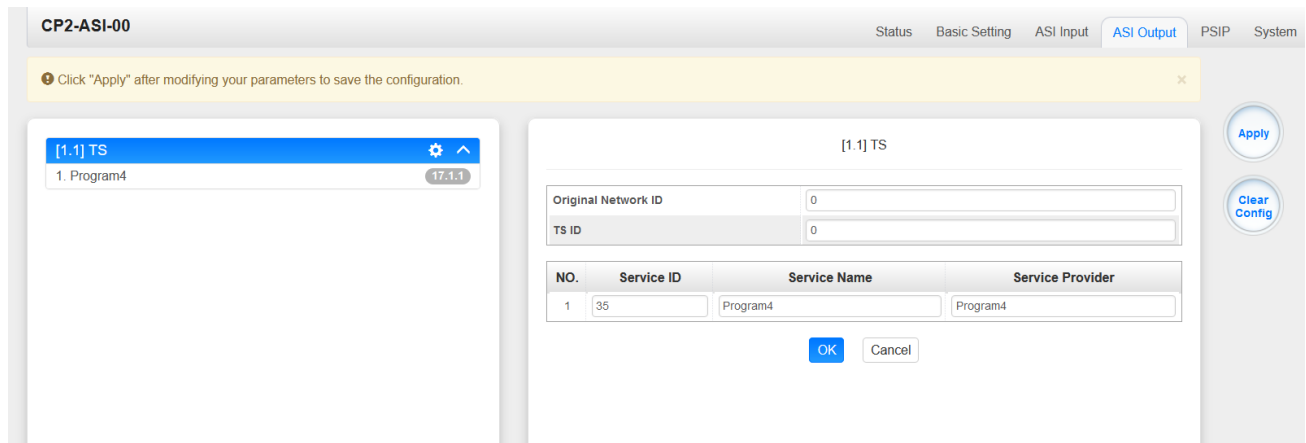

CP2-ASI-00

Status Basic Setting ASI Input **ASI Output** PSIP System

Click "Apply" after modifying your parameters to save the configuration.

[1.1] TS

1. Program4 17.1.1

[1.1] TS

Original Network ID 0

TS ID 0

NO.	Service ID	Service Name	Service Provider
1	35	Program4	Program4

OK Cancel

Apply

Clear Config

- TS setting: Please refer to IP Output service configuration on baseboard IP output.
- LCN setting: You need to add NIT streams of all frequencies to the base TS (frequency), which is for your STB to automatically search and identify all the TS (frequencies) LCN information.
 - Check or reset Original Network ID and TS ID of each TS (frequency). Each TS should have different IDs.
 - Fill the Original Network ID and TS ID of each TS (frequency) in the field of the base TS (frequency) and then click **Add** to create a NIT stream for this TS (frequency).
 - Click **+Descriptor** then **LCN Descriptor** to check all the programs which are contained in this frequency. Then set programs LCN.

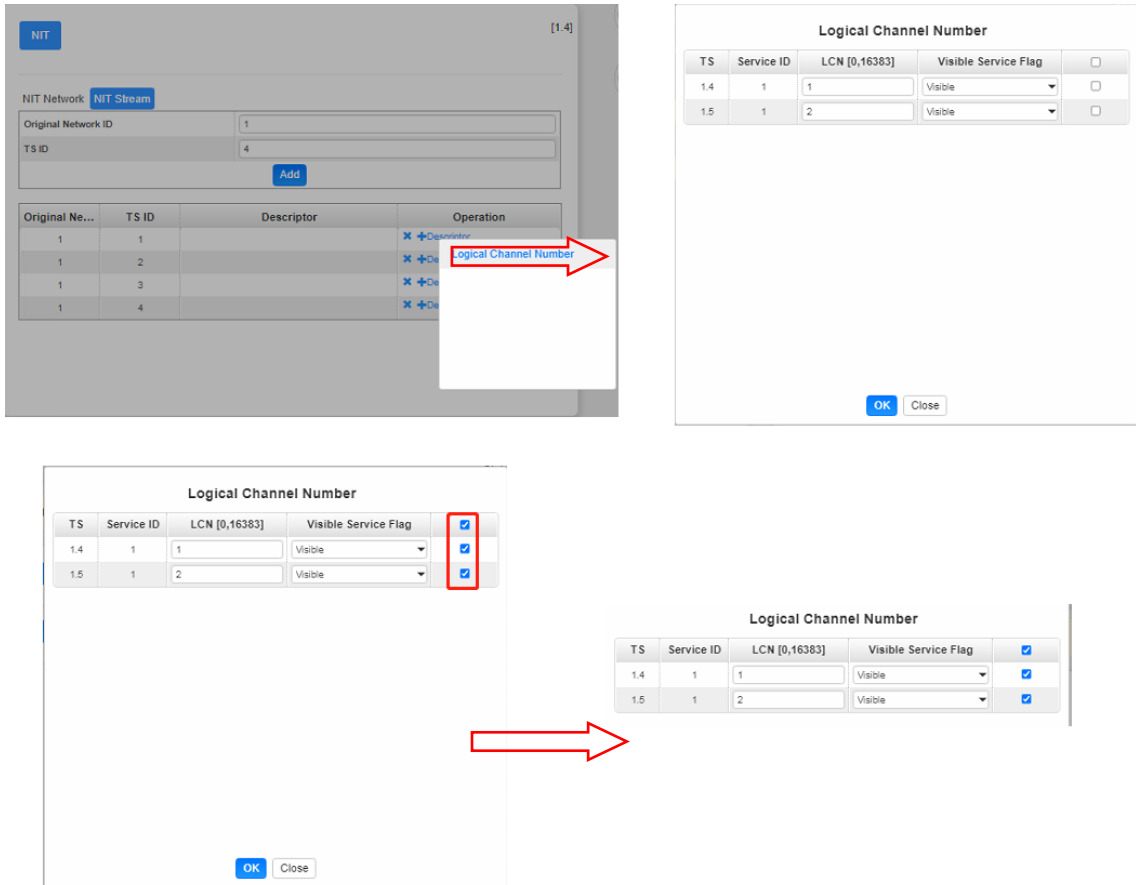

- Repeat the operations to add next TS (frequency) until NIT streams of all the frequencies have been included. Finally click **Apply** to let all configuration take effect. Then searching programs in your STB, you will get all programs in the order of LCN you set.

CP2-ASI-00>PSIP

Here in PSIP tab, the user can insert different tables like PAT, PMT, SDT,NIT, and CAT.

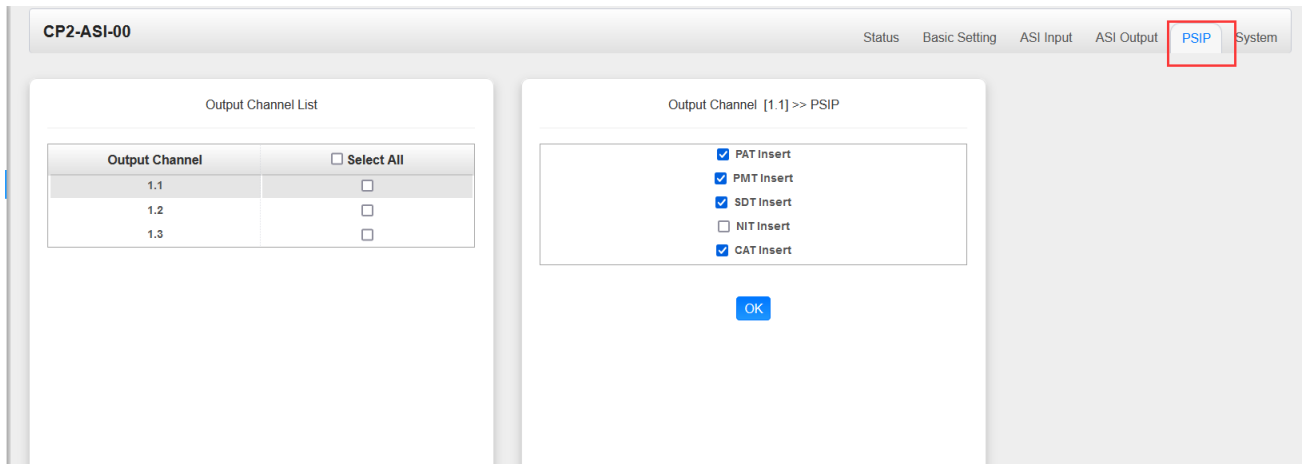

CP2-ASI-00>System

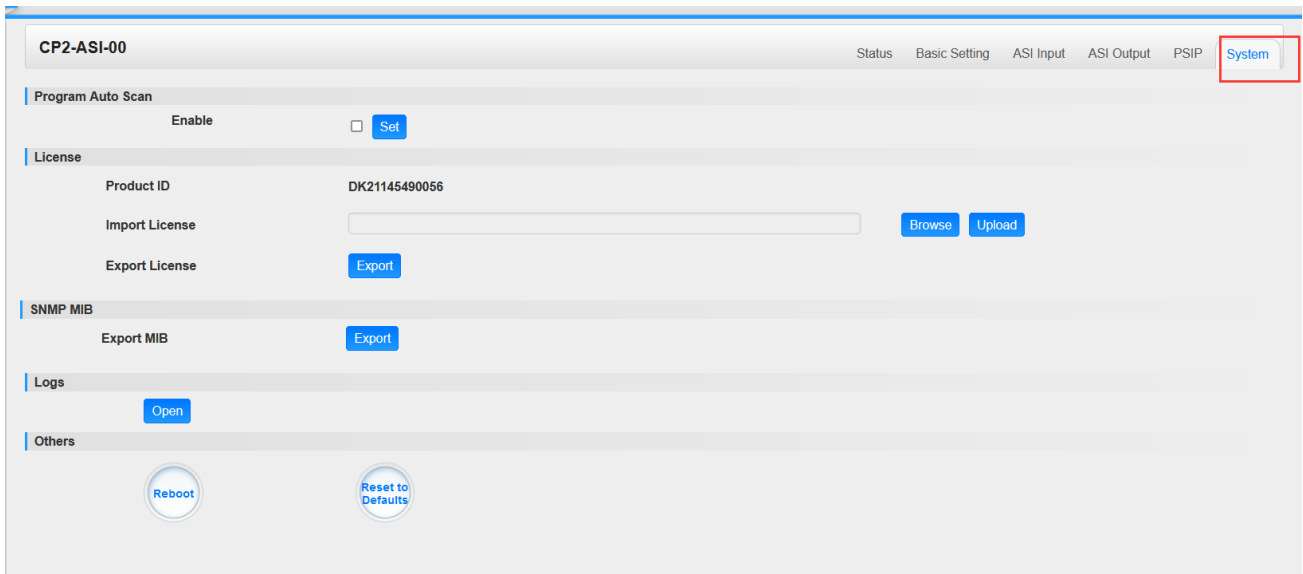

On **System** page you can choose to: Import/Export license, Export SNMP/MIB, Manage logs ,Reboot the unit, Restore the unit to factory defaults

5.4.5 CP2-IP-00

CP-IP-00 is an IP module that supports multiple network protocols such as UDP/RTP/HLS/RTSP/SRT/Zixi/RIST. The module has 1 internal GbE port, 3 external GbE ports, 1 USB port and 1 Mini-HDMI port. The GbE ports will be used for IP stream input and output while USB ports and Mini-HDMI port will be used for OS installation. With CP2-IP-00 module, you are able to output any program streams via different network protocols or receive any network streams and convert to RF signal for further transmission.



CP2-IP-00 >Status



The CPU status (**CPU: 1%**) is shown as a percentage. It reflects the amount of processing capacity that is currently being used.

The System Status (**System Status**) which reports the current status of the system. Green indicates the system operation is good while Red indicates there is some detail about the system that is currently in Alarm condition. A Red condition prompts the user to seek further information about the Alarm condition by viewing the Logs tab.

CP2-IP-00 >Basic Settings

The Basic Settings Tab is used to configure the video processing details. This will include signal direction (transmit, receive or both), addresses to be received or delivered to and labeling of the gateways to help the user distinguish gateways from one another.

The number of available gateways will depend upon the license key that is applied.

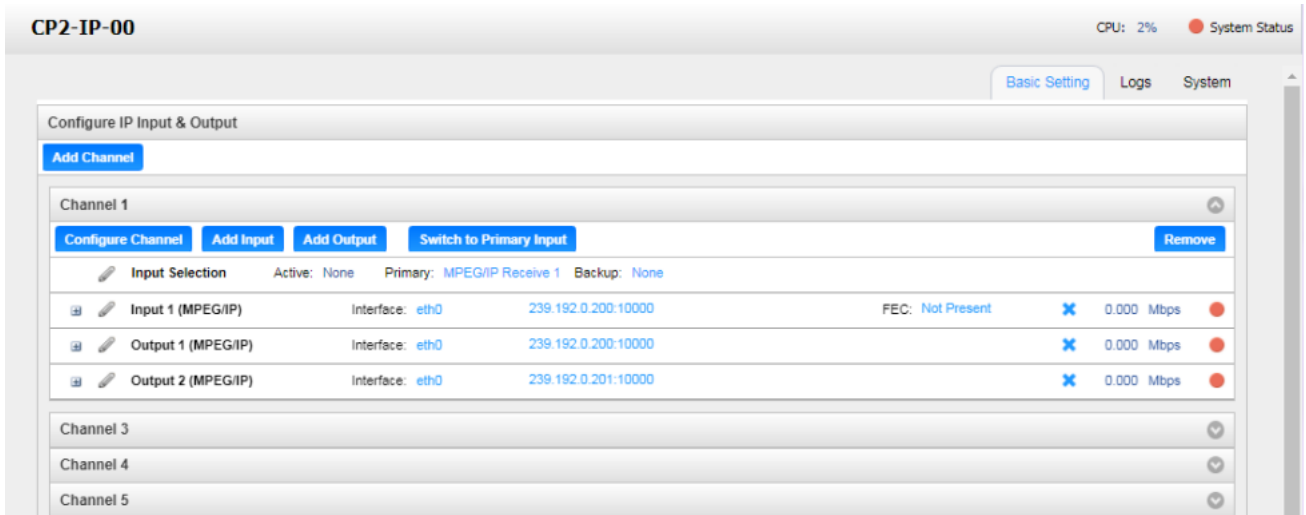

Adding a Channel

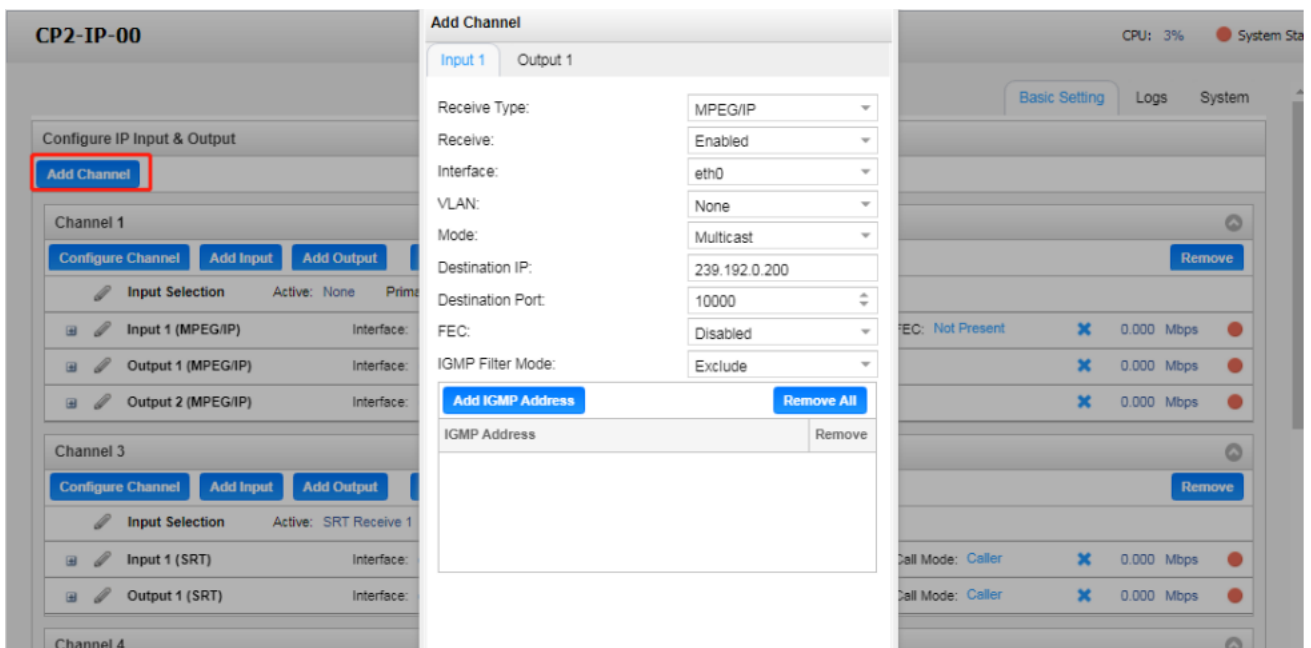

Click on the **Add Channel** button in the upper left area of the page to create a new or additional gateway. This will open a configuration window and allow the user to define the 'Alias' or label for the gateway; the receive and/or transmit addresses

The configuration window that opens will provide the user with two tabs: Input and Output.

The Input tab(s) is where the user will define the details for the stream to be received and any IGMP filtering. The Output tab(s) will define the details for the stream(s) to be sent out of this gateway.

Input Settings

This menu is used to configure IP receive settings for MPEG/IP, SRT, Zixi, HLS, Seamless RTP (SMPTE 2022-7 for Hitless Switching) and RIST inputs. Based upon the type of protocol the user selects, the available configuration settings will adapt to provide the best fit.

Three settings that are common to all protocols are “Receive”, which can be set to Enabled or Disabled, “Interface”, which can be set to eth0, eth1, eth2 or Internal (options may change depending on the number of interfaces and user defined interface name) and “VLAN”, which will filter incoming streams for VLAN tags.

Add Channel

Input 1 Output 1

Receive Type: MPEG/IP

Receive: Enabled

Interface: eth0

VLAN: None

Mode: Multicast

Destination IP: 239.192.0.200

Destination Port: 10000

FEC: Disabled

IGMP Filter Mode: Exclude

Add IGMP Address **Remove All**

IGMP Address	Remove
--------------	--------

Apply **Cancel**

Universal Input Settings

Note: when the “Receive” option is enabled for a given protocol (MPEG/IP, SRT, Zixi, HLS, Seamless RTP or RIST), the gateway will be capable of receiving incoming bitrate for that protocol. When using multiple receive instances on the same gateway, the “Receive” setting will not engage the newly

*configured receive instance as the active input by itself. To configure the additional receive as the active input, please review “**Configuring Active Inputs and Failover**”*

MPEG/IP Receive Settings

The figure below shows the options available when the “Receive Type” is set to “MPEG/IP”.

Add Channel

Input 1
Output 1

Receive Type:	<input type="text" value="MPEG/IP"/>
Receive:	<input type="text" value="Enabled"/>
Interface:	<input type="text" value="eth0"/>
VLAN:	<input type="text" value="None"/>
Mode:	<input type="text" value="Multicast"/>
Destination IP:	<input type="text" value="239.192.0.200"/>
Destination Port:	<input type="text" value="10000"/>
FEC:	<input type="text" value="Disabled"/>
IGMP Filter Mode:	<input type="text" value="Exclude"/>

Add IGMP Address
Remove All



IGMP Address	Remove

Apply
Cancel

MPEG/IP Receive Settings

Settings	Range	Description
----------	-------	-------------

Mode	Multicast	Multicast setting allows the unit to receive multicast streams. Multicast streams originate from the IP range 224.0.0.0 – 239.255.255.255. Unicast allows the unit to receive unicast streams. Unicast streams originate directly from a source device.
	Unicast	
Destination IP	224.0.0.0 – 239.255.255.255	This setting is only available when receiving a multicast stream. This is the address the unit will attempt to join.
Destination Port	0 - 65535	This is the UDP port the source device is sending to. This is the only setting required to receive a unicast stream but is also required for multicast.
FEC	Enabled	Sets the port to accept FEC on the incoming MPEG/IP stream
	Disabled	
IGMP Filter Mode	Exclude	Used on networks supporting IGMPv3. If this setting is set to Exclude, any streams originating from the user defined IP addresses will be included in the IGMP messages and the network will not forward these streams to the device. If this setting is set to Include, any streams originating from the user defined IP addresses will be included in the IGMP messages and the network will only forward these streams to the device.
	Include	

Click the  icon by the MPEG/IP input to view information about the incoming stream. Clicking the  icon will hide the IP statistics.

MPEG/IP Receive Statistics

The **Reset Counters** button is used to reset all the statistics for incoming IP packets and establish a new point of reference.

SRT Receive Settings

The figure below shows the options available when the “Receive Type” is set to “SRT”.



Input 1
Output 1

Receive Type:	<input type="text" value="SRT"/>
Receive:	<input type="text" value="Enabled"/>
Interface:	<input type="text" value="eth0"/>
VLAN:	<input type="text" value="None"/>
Call Mode:	<input type="text" value="Caller"/>
Remote Host:	<input type="text" value="1.0.0.1"/>
Remote Port:	<input type="text" value="10000"/>
Local Port Mode:	<input type="text" value="Auto"/>
Local Port:	<input type="text" value="10000"/>
Discovery Timeout (seconds):	<input type="text" value="3"/>
Latency (ms):	<input type="text" value="20"/>
Passphrase:	<input type="text" value="*****"/>

SRT Receive Settings

Settings	Range	Description
Call Mode	Caller	Defines the 'handshake' mechanism to be used when establishing connection.
	Listener	
	Rendezvous	

Remote Host	xxx.xxx.xxx.xxx	Defines the IP address of the stream on the remote device
Remote Port	0-65535	Defines the port of the stream on the remote devices
Local Port Mode	Auto	In Auto mode, the local port number will be assigned automatically
	Manual	In Manual mode, the local port number will be defined by the user
Local Port	1-65535	Defines the local port number
Discovery Timeout (seconds)	1 – 100, use 0 for infinite	Defines the length of time to wait for the stream to be discovered
Latency (ms)	1-8000	Defines buffer size in milliseconds
Passphrase	10 – 79 characters	Defines the encryption passphrase

Click the  icon by the SRT input to view information about the incoming stream. Clicking the  icon will hide the SRT receive statistics.

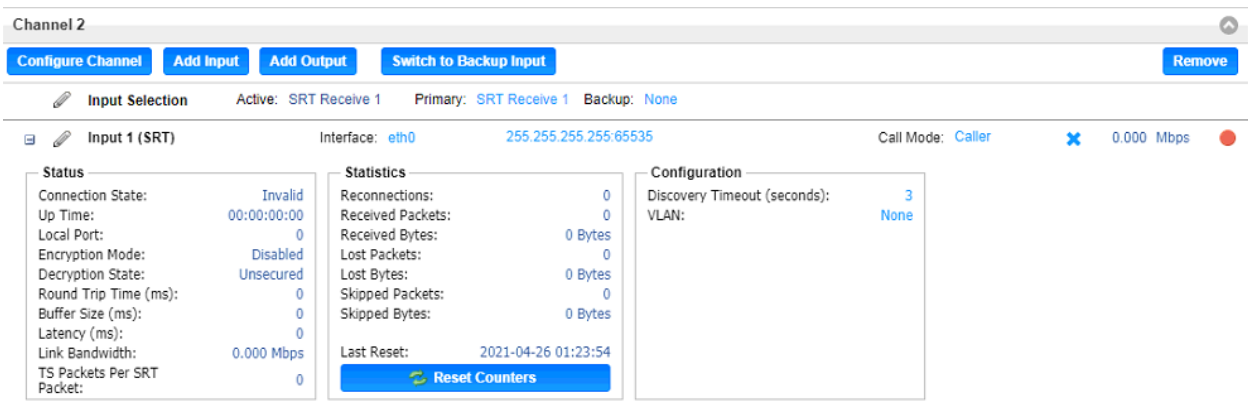

The screenshot shows the configuration page for Channel 2. At the top, there are buttons for 'Configure Channel', 'Add Input', 'Add Output', 'Switch to Backup Input', and 'Remove'. Below these, the 'Input Selection' section shows 'Active: SRT Receive 1', 'Primary: SRT Receive 1', and 'Backup: None'. The 'Input 1 (SRT)' section is expanded, showing the following details:

- Interface: eth0
- Address: 255.255.255.255:65535
- Call Mode: Caller
- Bandwidth: 0.000 Mbps

The 'Statistics' section displays the following data:

Reconnections:	0
Received Packets:	0
Received Bytes:	0 Bytes
Lost Packets:	0
Lost Bytes:	0 Bytes
Skipped Packets:	0
Skipped Bytes:	0 Bytes

The 'Configuration' section shows:

- Discovery Timeout (seconds): 3
- VLAN: None

At the bottom of the statistics section, there is a 'Reset Counters' button.

SRT Receive Statistics

The **Reset Counters** button is used to reset all the statistics for incoming SRT packets and establish a new point of reference.

Zixi Receive Settings

The figure below shows the options available when the “Receive Type” is set to “Zixi”.



The screenshot shows a configuration window with two tabs: "Input 1" (selected) and "Output 1". The "Input 1" tab contains the following settings:

Receive Type:	Zixi
Receive:	Enabled
Interface:	eth0
VLAN:	None
Remote Host:	
Alternate Remote Host:	
Remote Port:	2077
Stream ID:	
Remote ID:	
Password:	
Ignore TLS Certificate Error:	Do Not Ignore
Maximum Latency (ms):	4000
Decryption Mode:	Disabled
Decryption Key:
FEC Overhead (%):	30

At the bottom right of the window are two buttons: "Apply" and "Cancel".

Zixi Receive Settings

Settings	Range	Description
Remote Host	xxx.xxx.xxx.xxx Domain Name	Defines the host of the remote broadcast using IP address or domain name
Alternate Remote Host	xxx.xxx.xxx.xxx Domain Name	Defines the alternate host of the remote broadcast using IP address or domain name
Remote Port	0 – 65535	Defines the port of the stream on the remote device
Stream ID	User entry	Defines the Zixi stream ID to be received
Remote ID	User entry	Specify the Zixi Broadcaster or Feeder ID that will push the stream
Password	User entry	Provides the password to allow specific Stream ID entered to be received
Ignore TSL certificate Error	Do Not Ignore Ignore	Defines whether to cease or continue processing if TLS Certificate Error is signaled
Maximum Latency (ms)	30 – 10,000	Defines the maximum latency or buffer size (in milliseconds)
Decryption Mode	Disabled AES-128 AES-192 AES-256 Automatic	Defines if a decryption of the received signal is needed, which decryption standard to use, or if the CP2-IP-00 will automatically detect these
Decryption Key	User entry	Provides the key to allow signal processing if decryption is to be done
FEC Overhead (%)	0 – 50	Defines the amount of static overhead to be used to accommodate FEC

Click the  icon by the Zixi input to view information about the incoming stream. Clicking the  icon will hide the Zixi receive statistics.

Zixi Receive Statistics

The  button is used to reset all the statistics for incoming Zixi packets and establish a new point of reference.

HLS Receive Settings

The figure below shows the options available when the “Receive Type” is set to “HLS”

Configure

Input 1
Output 1

Receive Type: HLS

Receive: Enabled

Interface: eth2

VLAN: None

HLS Mode: Pull

HLS Network Location: http://playertest.longtailvideo

Apply and Refresh

Profile Name	Bandwidth

Decryption Mode: Disabled

Decryption Key:

Discovery Timeout (seconds): 3

Apply
Cancel

HLS Receive Settings

Settings	Range	Description
HLS Mode	Push Pull	Determines if the HLS receives through a local or network location

HLS Network Location	User Entry	Defines address of the HLS stream to be received
Profile / Bandwidth	User Selected	After entering an HLS network location and clicking “Apply and Refresh”, a list of available profiles will be displayed
Decryption Mode	Disabled AES 128	Defines if a decryption of the received signal is needed, AES 128 standard
Decryption Key	User Entry	Provides the key to allow signal processing if decryption is to be done
Discovery Timeout (seconds)	1 – 100, use 0 for infinite	Defines the length of time to wait for the stream to be discovered

Seamless RTP Receive Settings

The figure below shows the options available when the “Receive Type” is set to “Seamless RTP”.

Configure

Input 1 Output 1

Receive Type: Seamless RTP

Receive: Enabled

Path 1 Interface: eth0

VLAN: None

Path 1 Destination IP: 239.192.0.200

Path 1 Destination Port: 10000

Path 1 IGMP Filter Mode: Exclude

Add IGMP Address
Remove All

IGMP Address	Remove

Path 2 Interface: eth0

VLAN: None

Path 2 Destination IP: 239.192.0.200

Path 2 Destination Port: 10000

Path 2 IGMP Filter Mode: Exclude

Add IGMP Address
Remove All

IGMP Address	Remove

Apply
Cancel

Seamless RTP Receive Settings

Settings	Range	Description
Path 1 or 2 Destination IP	xxx.xxx.xxx.xxx	Defines the address of the first or second path to be received

Path 1 or 2 Destination Port	1 - 65535	Defines the port of the first or second path to be received
Path 1 or 2 IGMP Filter Mode	Include, Exclude	Defines filter to include or exclude addresses contained in IGMP list box
Path 1 or 2 IGMP List Box	The list box for each path will comprise the addresses entered by the user, and define the sources input signals can be accepted from (Include), or sources that input signals are not to be accepted from (Exclude)	

Click the  icon by the Seamless RTSP input to view information about the incoming stream.

Clicking the  icon will hide the Seamless RTSP receive statistics.

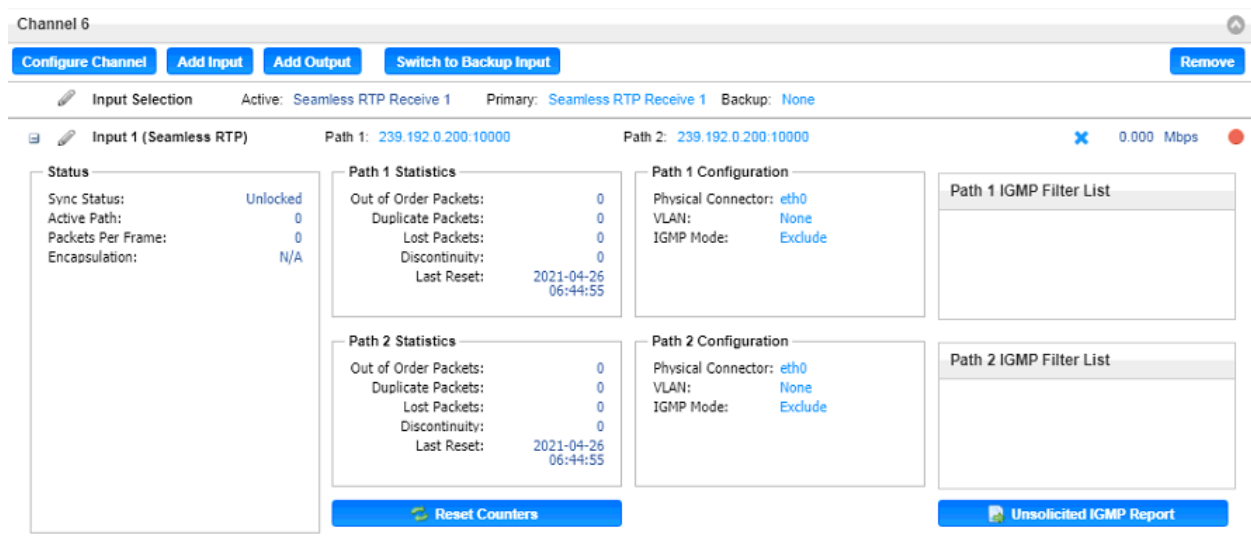

The screenshot shows the 'Channel 6' configuration page. At the top, there are buttons for 'Configure Channel', 'Add Input', 'Add Output', 'Switch to Backup Input', and 'Remove'. Below this, the 'Input Selection' section shows 'Active: Seamless RTP Receive 1', 'Primary: Seamless RTP Receive 1', and 'Backup: None'. The main area is titled 'Input 1 (Seamless RTP)' and shows two paths: Path 1 (239.192.0.200:10000) and Path 2 (239.192.0.200:10000). The current rate is 0.000 Mbps. The interface is divided into several panels: 'Status' (Sync Status: Unlocked, Active Path: 0, Packets Per Frame: 0, Encapsulation: N/A), 'Path 1 Statistics' (Out of Order Packets: 0, Duplicate Packets: 0, Lost Packets: 0, Discontinuity: 0, Last Reset: 2021-04-26 06:44:55), 'Path 1 Configuration' (Physical Connector: eth0, VLAN: None, IGMP Mode: Exclude), 'Path 1 IGMP Filter List', 'Path 2 Statistics' (Out of Order Packets: 0, Duplicate Packets: 0, Lost Packets: 0, Discontinuity: 0, Last Reset: 2021-04-26 06:44:55), 'Path 2 Configuration' (Physical Connector: eth0, VLAN: None, IGMP Mode: Exclude), and 'Path 2 IGMP Filter List'. At the bottom, there are two buttons: 'Reset Counters' and 'Unsolicited IGMP Report'.

Seamless RTSP Receive Statistics

The  button is used to reset all the statistics for incoming Seamless RTSP and establish a new point of reference.

RIST Receive Settings

The figure below shows the options available when the “Receive Type” is set to “RIST”.

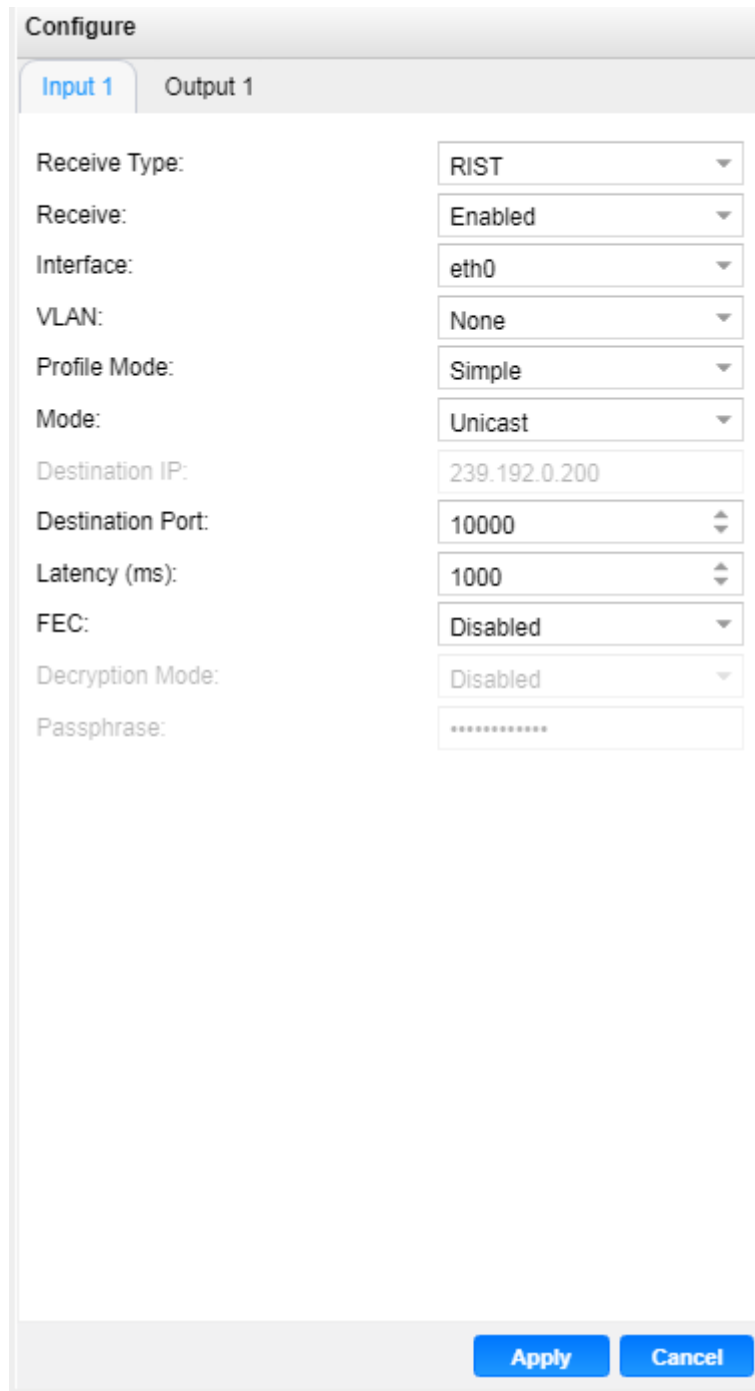



The screenshot shows a configuration window titled "Configure" with two tabs: "Input 1" (selected) and "Output 1". The settings are as follows:

Setting	Value
Receive Type:	RIST
Receive:	Enabled
Interface:	eth0
VLAN:	None
Profile Mode:	Simple
Mode:	Unicast
Destination IP:	239.192.0.200
Destination Port:	10000
Latency (ms):	1000
FEC:	Disabled
Decryption Mode:	Disabled
Passphrase:

At the bottom right of the window are two buttons: "Apply" and "Cancel".

RIST Receive Settings

Settings	Range	Description
Profile Mode	Simple Main	Specifies the RIST profile mode by which to receive the incoming stream
Mode	Unicast Multicast	Multicast setting allows the unit to receive multicast streams. Multicast streams originate from the IP range 224.0.0.0 – 239.255.255.255. Unicast allows the unit to receive unicast streams. Unicast streams originate directly from a source device
Destination IP	xxx.xxx.xxx.xxx	Defines the address of the stream to be received
Destination Port	1026 – 65534	Defines the port of the stream to be received. When using Simple Profile Mode, only even numbers are valid.
Latency (ms)	1 – 8000	Defines buffer size in milliseconds
Decryption Mode	Disabled DTLS PSK	Specifies if the incoming RIST stream needs to be decrypted. Can only be enabled when using Main Profile Mode. DTLS Decryption will require public and private keys as configured
Passphrase	User entry	Provides the key to allow signal processing if PSK decryption is to be done

Click the  icon by the RIST input to view information about the incoming stream. Clicking the  icon will hide the RIST receive statistics.

Channel 5

Configure Channel Add Input Add Output Switch to Backup Input Remove

Input Selection Active: RIST Receive 1 Primary: RIST Receive 1 Backup: None

Input 1 (RIST) Interface: eth0 255.255.255.255/65535 0.000 Mbps

Status	Statistics	Configuration
Connection State: Invalid	Reconnections: 0	VLAN: None
Up Time: 00:00:00:00	Received Packets: 0	Profile Mode: Simple
Decryption State: Unsecured	Received Bytes: 0 Bytes	Stream Mode: Unicast
Round Trip Time (ms): 0	Lost Packets: 0	Decryption Mode: Disabled
Buffer Size (ms): 0	FEC Uncorrected Packets: 0	FEC State: Disabled
Jitter (ms): 0	FEC Recovered Packets: 0	
Latency (ms): 0	RTCP NAKs: 0	
Link Bandwidth: 0.000 Mbps	RTCP Recovered Packets: 0	
FEC Cols: 0		
FEC Rows: 0		
TS Packets per RIST Packet: 0		
	Last Reset: 2021-04-26 01:24:56	

Reset Counters

RIST Receive Statistics

The **Reset Counters** button is used to reset all the statistics for incoming RIST packets and establish a new point of reference.

Output Settings

This menu is used to configure IP transmit settings for MPEG/IP, SRT, Zixi and RIST. The output available configuration options will change based on the protocol the user selects for the “Transmit Type” field.

There are three settings common to all protocols: “Transmit”, which can be set to Enabled or Disabled, “Interface”, which can be set to eth0 or eth1 (options may change depending on number of interfaces and user defined interface name) and “VLAN”, which will add VLAN tags to outbound streams.

Configure

Input 1 **Output 1**

Transmit Type:	MPEG/IP
Transmit:	Enabled
Interface:	eth0
VLAN:	None
Destination IP:	239.192.0.201
Destination Port:	10000
Source IP Mode:	Auto
Source IP:	0.0.0.0
Source Port:	3020
Source MAC Mode:	Auto
Source MAC:	00:00:00:00:00:00
TS Packets Mode:	Auto
TS Packets Per IP Packet:	7
Encapsulation:	UDP

Apply **Cancel**

Universal Transmit Settings

MPEG/IP Output Settings

The figure shows the options available when the “Transmit Type” is set to “MPEG/IP”.

Transmit Type:	MPEG/IP
Transmit:	Enabled
Interface:	eth0
VLAN:	None
Destination IP:	239.192.0.200
Destination Port:	10000
Source IP Mode:	Auto
Source IP:	0.0.0.0
Source Port:	3020
Source MAC Mode:	Auto
Source MAC:	00:00:00:00:00:00
TS Packets Mode:	Auto
TS Packets Per IP Packet:	7
Encapsulation:	UDP

MPEG/IP Output Settings

Settings	Range	Description
Destination IP	224.0.0.0 – 239.255.255.255	This setting is only available when receiving a multicast stream. This is the address the unit will attempt to join

Destination Port	0 – 65535	This is the UDP port the source device is sending to. This is the only setting required to receive a unicast stream but is also required for multicast
Source IP Mode	Auto Manual	When set to <i>Auto</i> , the source IP address on the output stream will match the corresponding local interface. When set to <i>Manual</i> , a user entered address can be assigned to the output stream
Source IP	xxx.xxx.xxx.xxx	Defines the Source IP address to be assigned to the output stream
Source Port	0 – 65535	Defines the source IP port to be assigned to the output stream
Source MAC Mode	Auto Manual	When set to <i>Auto</i> , the source MAC address of the output stream will match the corresponding local interface. When set to <i>Manual</i> , a user entered address can be assigned to the output stream
Source MAC	xx:xx:xx:xx:xx:xx	The user defined MAC for when using Manual MAC Mode
TS Packets Mode	Auto Manual	In <i>Auto</i> mode, the source will define the number of TS packets per IP packet. In <i>Manual</i> mode, the user will define the number of TS packets per IP packet
TS Packets per IP Packet	1-7	The number of TS packets that are contained with a single IP packet. Default is 7. Lowering this value below default increases network overhead
Encapsulation	UDP RTP	Sets the Encapsulation to UDP or RTP



SRT Output Settings

The figure below shows the options available when the “Transmit Type” is set to “SRT”.

SRT Output Settings

Settings	Range	Description
Call Mode	Caller	Defines the 'handshake' mechanism to be used when establishing connection.
	Listener	
	Rendezvous	
Remote Host	xxx.xxx.xxx.xxx	Defines the IP address of the stream on

		the remote device
Remote Port	0 – 65535	Defines the port of the stream on the remote devices
Local Port Mode	Auto Manual	In <i>Auto</i> mode, the local port number will be assigned automatically In <i>Manual</i> mode, the local port number will be defined by the user
Local Port	1 – 65535	Defines the local port number
Discovery Time (seconds)	1 – 100, use 0 for infinite	Defines the length of time to wait for the stream to be discovered
Latency (ms)	1 – 8000	Defines buffer size in milliseconds
Bandwidth Overhead (%)	0 – 50	Defines the amount of bandwidth overhead to allow for
TS Packets Mode	Auto Manual	In <i>Auto</i> mode, the source will define the number of TS packets per SRT packet. In <i>Manual</i> mode, the user will define the number of TS packets per SRT packet
TS Packets per SRT Packet	1 – 7	Defines the number of TS packets per SRT packet when mode is <i>Manual</i>
Time To Live (hops)	1 – 254	Defines the number of network devices the transmission is allowed to pass through
Type of Service	0 – 255	Specifies the desired Quality of Service (QoS). This value will be assigned to the Type of Service field of the IP Header for the outgoing stream.
Encryption Mode	Disabled AES-128 AES-256	Defines which encryption standard to use or if the CP2-IP-00 will automatically detect this.
Passphrase	10 – 79 characters	Defines the encryption passphrase

Click the  icon by the SRT input to view information about the incoming stream. Clicking the  icon will hide the SRT output statistics.

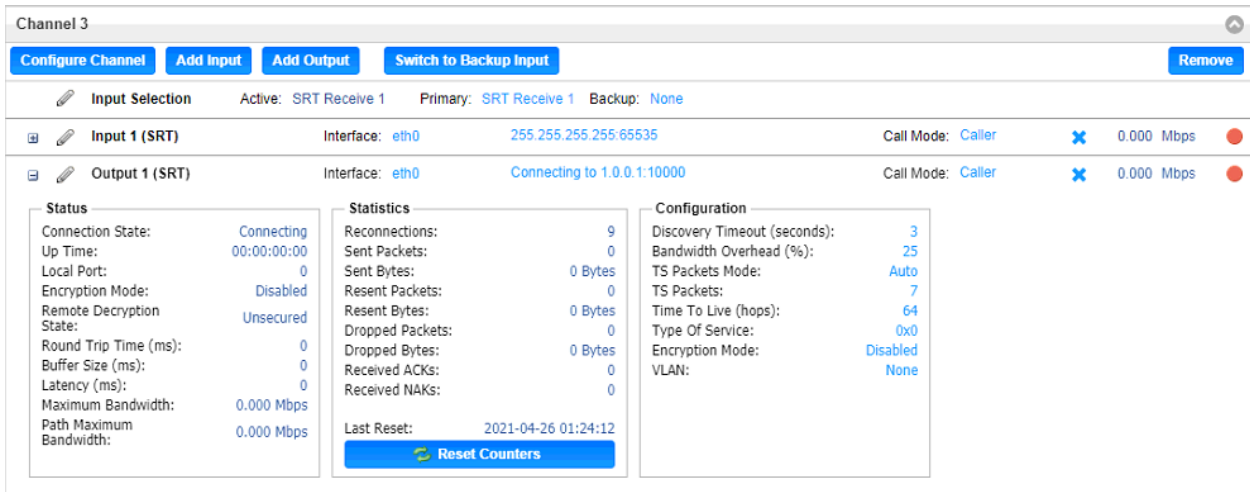

The screenshot shows the 'Channel 3' configuration page. At the top, there are buttons for 'Configure Channel', 'Add Input', 'Add Output', 'Switch to Backup Input', and 'Remove'. Below these, the 'Input Selection' section shows 'Active: SRT Receive 1', 'Primary: SRT Receive 1', and 'Backup: None'. There are two SRT inputs listed: 'Input 1 (SRT)' and 'Output 1 (SRT)'. Each input shows its interface (eth0), IP address, and call mode (Caller). The 'Output 1 (SRT)' is currently in a 'Connecting' state. Below the input list, there are three panels: 'Status', 'Statistics', and 'Configuration'. The 'Status' panel shows connection details like 'Connection State: Connecting' and 'Up Time: 00:00:00:00'. The 'Statistics' panel shows metrics such as 'Reconnections: 9', 'Sent Packets: 0', and 'Received ACKs: 0'. The 'Configuration' panel shows settings like 'Discovery Timeout (seconds): 3' and 'Bandwidth Overhead (%): 25'. A 'Reset Counters' button is located at the bottom of the 'Statistics' panel.

SRT Output Statistics

The  button is used to reset all the statistics for incoming SRT packets and establish a new point of reference.

Zixi Output Settings

The figure below shows the options available when the “Transmit Type” is set to “Zixi”.

Input 1
Output 1

Transmit Type:Zixi ▾

Transmit:Enabled ▾

Interface:eth0 ▾

VLAN:None ▾

Remote Host:

Alternate Remote Host:

Remote Port:2088 ▾

Stream ID:

Password:

Ignore TLS Certificate Error:Do Not Ignore ▾

Maximum Latency (ms):4000 ▾

Encryption Mode:Disabled ▾

Encryption Key:.....

Maximum Bitrate (Mbps):8 ▾

FEC Overhead (%):30 ▾

TS Packets Mode:Auto ▾

TS Packets Per Zixi Packet:7 ▾

Bonding Mode:Disabled ▾

Interface ↑	Bandwidth Limit(Mbps)	Priority
Internal	8	Primary
eth0	8	Primary
eth1	8	Primary
eth2	8	Primary

Apply
Cancel

Zixi Output Settings

Settings	Range	Description
Remote Host	xxx.xxx.xxx.xxx Domain Name	Defines the host of the remote broadcast using an IP address or domain name
Alternate Remote Host	xxx.xxx.xxx.xxx Domain Name	Defines the alternate host of the remote broadcast using an IP address or domain name
Remote Port	0 – 65535	Defines the port of the stream on the remote device

Stream ID	User entry	Defines the Zixi stream ID to be transmitted
Password	User entry	Provides the password to allow specific Stream ID entered to be received
Ignore TLS Certificate Error	Do Not Ignore Ignore	Defines whether to cease or continue processing if TLS Certificate Error is signaled
Maximum Latency (ms)	30 – 10,000	Defines the maximum latency or buffer size (in milliseconds)
Encryption Mode	Disabled AES-128 AES-192 AES-256 Automatic	Defines which encryption standard to use or if the CP2-IP-00 will automatically detect this
Encryption Key	User entry	The key to be used by downstream decryption devices
FEC Overhead (%)	0 – 50	Defines the amount of static overhead to be used to accommodate FEC
TS Packets Mode	Auto Manual	In <i>Auto</i> mode, the source will define the number of TS packets per Zixi packet. In <i>Manual</i> mode, the user will define the number of TS packets per Zixi packet.
TS Packets per Zixi Packet	1 – 7	User defined value for when <i>Manual</i> mode is enabled.
Bonding Mode	Disabled All interfaces One Interface Any Interface	Specifies which interfaces, if any, are to be set to bonding mode.

Interface Bonding Box	Available for One Interface Mode Any Interface Mode	Allows user to define parameters and details about the port(s) when bonding
------------------------------	--	---



Zixi transmissions can be configured to use multiple interfaces simultaneously (Port Bonding). By defining the maximum bitrate for that interface, the unit will only send up to that rate on that interface. A Primary and Backup interface may also be chosen if redundant links should be used.

Interface ↑	Bandwidth Limit(Mbps)	Priority
Internal	8	Primary
eth0	8	Primary
eth1	8	Primary
eth2	8	Primary

Interface ↑	Bandwidth Limit(Mbps)	Priority
Internal	8	Primary
eth0	8	Primary
eth1	8	Primary
eth2	8	Primary

Interface ↑	Bandwidth Limit(Mbps)	Priority
Internal	8	Primary
eth0	8	Primary
eth1	8	Backup
eth2	8	Primary

Interface Bonding Boxes

Click the  icon by the Zixi input to view information about the incoming stream. Clicking the  icon will hide the Zixi Output statistics.

The screenshot displays the configuration page for 'Output 1 (Zixi)' on interface 'eth0', connecting to ':2088/'. The page is divided into several sections:

- Status:** Shows 'Connection State: Connecting', 'Up Time: 00:00:00:00', 'Round Trip Time (ms): 0', 'Jitter (ms): 0', and 'Maximum Bandwidth: 0.000 Mbps'.
- Statistics:** Lists various metrics such as 'Reconnections: 889', 'Sent Packets: 0', 'Sent Bytes: 0 Bytes', 'Drooped Packets: 0', 'Not Recovered Packets: 0', 'FEC Packets: 0', 'FEC Recovered Packets: 0', 'ARO Packets: 0', 'ARQ Recovered Packets: 0', 'ARQ Duplicate Packets: 0', and 'ARO Requests: 0'.
- Configuration:** Includes settings like 'Password:', 'Ignore TLS Certificate Error: Do Not Ignore', 'Maximum Latency (ms): 4,000', 'Decryption Mode: Disabled', 'Maximum Bitrate: 8.000 Mbps', 'FEC Overhead (%): 30', 'TS Packets Mode: Auto', 'TS Packets: 7', 'Bonding Mode: Disabled', and 'VLAN: None'.
- Bonding Interfaces:** A table showing the configuration for bonded interfaces.

Interface ↑	Bandwidth Limit(Mbps)	Priority
Internal	8	Primary
eth0	8	Primary
eth1	8	Primary
eth2	8	Primary

Zixi Output Statistics

The **Reset Counters** button is used to reset all the statistics for incoming Zixi packets and establish a new point of reference.

RIST Output Settings

The figure below shows the options available when the “Transmit Type” is set to “RIST”.

Input 1
Output 1

Transmit Type:

Transmit:

Interface:

VLAN:

Profile Mode:

Tunneling Mode:

Destination IP:

Destination Port:

Source Port:

Latency (ms):

FEC Transmission:

FEC Columns:

FEC Rows:

Encryption Mode:

Passphrase:

Ignore TLS Certificate Error:

Bonding Mode:

Interface ↑	Bandwidth Limit(Mbps)	Priority
Internal	8	Primary
eth0	8	Primary
eth1	8	Primary
eth2	8	Primary

RIST Output Settings

Settings	Range	Description
Profile Mode	Simple Main	Specifies the RIST profile mode for the transmit instance. The <i>Simple</i> profile mode will output with the same packet structure as an RTP packet. The <i>Main</i> profile mode will add more header information for use with the tunnel function
Tunneling Mode	Full Datagram	When set to <i>Full Datagram</i> , the IP header

	Reduced Overhead	and UDP header will be re-added to each packet to help identify the channel. When set for <i>Reduced Overhead</i> , the source port and destination port will be added to the header to help identify the channel. Exclusive to Main Profile Mode.
Destination IP	xxx.xxx.xxx.xxx	Defines the address of the stream to be received
Destination Port	1026 – 65534	Defines the port of the stream to be received. When using <i>Simple Profile Mode</i> , only even numbers are valid.
Source Port	1026 – 65534	Specifies the transmit source port
Latency (ms)	1 – 8000 S	Specifies buffer size in milliseconds
Encryption Mode	Disabled DTLS PSK	Defines which encryption standard the RIST transmit instance will use. Exclusive to <i>Main Profile Mode</i> . DTLS encryption will require uploading public and private keys as configured in Enabling DTLS
Passphrase	User entry	The encryption passphrase. Exclusive to <i>PSK Encryption Mode</i> .
Ignore TLS Certificate Error	Do Not Ignore Ignore	Defines whether to cease or continue processing if TLS Certificate Error is signaled
Bonding Mode	Disabled All interfaces One Interface Any Interface	Specifies which interfaces, if any, are to be set to bonding mode. Bonding Mode settings cannot be chosen when Encryption Mode is set to DTLS.
Interface Bonding Box	Available for One	Allows user to define parameters and

Interface Mode details about the port(s) when bonding

Any Interface Mode



RIST transmissions can be configured to use multiple interfaces simultaneously (Port Bonding). By defining the maximum bitrate for that interface, the unit will only send up to that rate on that interface. A Primary and Backup interface may also be chosen if redundant links should be used.

Interface ↑	Bandwidth Limit(Mbps)	Priority
Internal	8	Primary
eth0	8	Primary
eth1	8	Primary
eth2	8	Primary

Interface ↑	Bandwidth Limit(Mbps)	Priority
Internal	8	Primary
eth0	8	Primary
eth1	8	Primary
eth2	8	Primary

Interface ↑	Bandwidth Limit(Mbps)	Priority
Internal	8	Primary
eth0	8	Primary
eth1	8	Backup
eth2	8	Primary

Interface Bonding Boxes

Click the  icon by the RIST input to view information about the incoming stream. Clicking the  icon will hide the RIST Output statistics.

Output 1 (RIST) Interface: eth0 255.255.255.255.65535 0.000 Mbps

Status

Connection State: Invalid
 Up Time:
 Round Trip Time (ms):
 Buffer Size (ms):
 Jitter (ms):
 Latency (ms):
 Link Bandwidth: 0.000 Mbps

Statistics

Reconnections:
 Sent Packets: Bytes
 Resent Packets: Bytes
 Lost Packets:
 RTCP NAKs:
 Last Reset: 2021-04-26 01:24:56
 Reset Counters

Configuration

VLAN: None
 Profile Mode: Simple
 Tunneling Mode: Full Datagram
 Source Port: 3020
 Encryption Mode: Disabled
 Bonding Mode: Disabled
 FEC Transmission: Off
 Ignore TLS: Do Not Ignore
 Certificate Error:

Bonding Interfaces



Interface ↑	Bandwidth Limit(Mbps)	Priority
Internal	8	Primary
eth0	8	Primary
eth1	8	Primary
eth2	8	Primary

RIST Output Statistics

The  button is used to reset all the statistics for incoming RIST packets and establish a new point of reference.

Additional Receive Instances

Each gateway can be configured for multiple input instances. To add an additional receive instance, click on the  button in the top left corner of the gateway section. The gateway configuration window will open with a new "Input 2" tab, offering the same settings as the initial input tab.

Removing a channel from the configuration can be done by clicking on the  button located at the right side of the channel ribbon. Any configured input instance can also be removed by clicking on the  button located within the input row. When either of the icons is clicked, the system will prompt the user with confirmation of intent to remove the item from the configuration

Only one additional input instance can be added, so the option becomes gray as shown below after the second path is added.

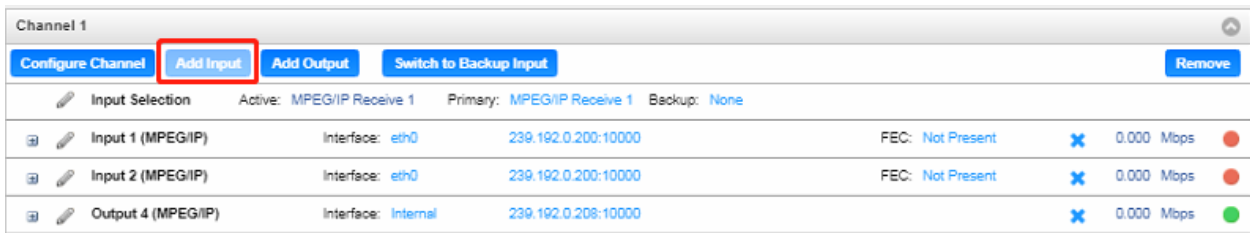

Multiple Input Instances

Configuring Active Inputs and Failover

When two input instances are configured, only one of them can be assigned to the output instances. The Input Selection menu is used to determine which receive instance is the primary and backup.

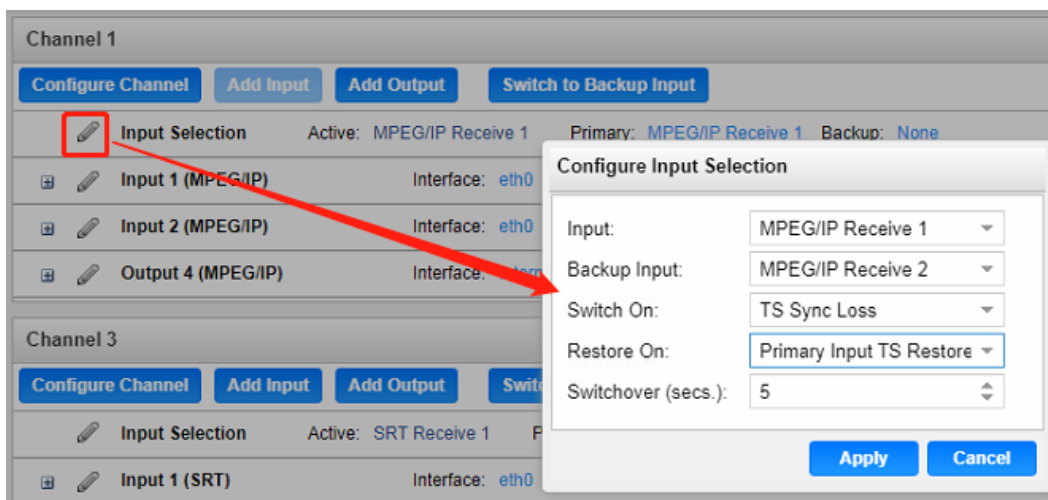

Settings	Range	Description
Input	Input 1	Used for both normal operation and input failover settings. During normal operation, this input will be the active input
	Input 2	
Backup Input	Input 1	During failover operation this input will become the active input. The catalyst for the unit to switch to this input is configured in the following setting.
	Input 2	
Switch On	Manual Only	Choose the event that triggers the switch from the primary to the backup input
	TS Sync Loss	
Restore On	Manual Only	Choose the event that triggers a switch back to the primary input
	Primary Input TS	

	Restored	
	Backup Input TS	
	Sync Loss	
Switchover (secs)	1 – 20	The amount of time the gateway must remain in the “Switch On” or “Restore On” state before automatic failover or switchback occurs

Clicking the **Switch to Backup Input** option under the channel will prompt the user for confirmation of intent to change the input instance assigning the output instances to source from input instance 2. Clicking **Switch to Primary Input** will assign the output instances to return to sourcing from input instance 1.

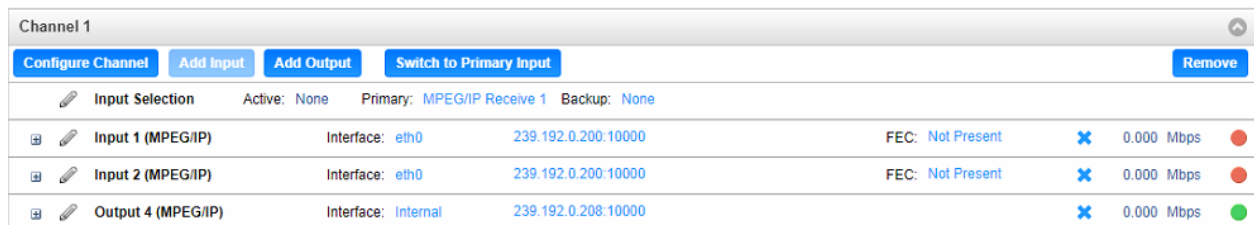

Active Backup Input

Additional Transmit Instance

The CP2-IP-00 will allow the user to configure a single channel for multiple output paths. To add an additional output path, click on the **Add Output** button in the top left corner of the Channel section. The channel configuration window will open with an additional “Output 2” tab. The new tab will offer the same settings as the initial output tab.

Removing a channel from the configuration can be done by clicking on the **Remove** button located at the right side of the Channel ribbon. Any configured output path can also be removed by clicking on the **X** button located within the output row that the user wishes to remove. When either of the icons

is clicked, the system will prompt the user with confirmation of intent to remove the item from the configuration.

Which input instance the output instances will source from is dependent on the settings.

Channel 1							
Configure Channel Add Input Add Output Switch to Primary Input		Remove					
	Input Selection	Active: None	Primary: MPEG/IP Receive 1	Backup: None			
	Input 1 (MPEG/IP)	Interface: eth0	239.192.0.200:10000	FEC: Not Present		0.000 Mbps	
	Output 1 (MPEG/IP)	Interface: eth0	239.192.0.200:10000			0.000 Mbps	
	Output 2 (MPEG/IP)	Interface: eth0	239.192.0.201:10000			0.000 Mbps	

CP2-IP-00 > Logs

Clicking the Logs tab will redirect the user in the Reporting Control Panel. The Reporting control panel in the CP2-IP-00 module will provide the user with a list of active alarms, as well as a means to log the detected events. Active alarms are constantly updated to reflect the real-time state of the unit. Once an error is no longer detected, it will be cleared from the active alarms window. The log files can be used to view alarm and event history. Both the active alarm and event logs can be configured for specific behavior based upon the user’s needs.

The screenshot shows the Reporting Control Panel interface. At the top, there are tabs for 'Basic Setting', 'Logs', and 'System'. Below the tabs, there are buttons for 'Alarms' and 'Logs', and a 'Configure' button. The main area displays a table of active alarms with columns for State, Name, Location, and Last Changed. Below this, there is a section for logs with buttons for 'Refresh', 'Clear', and 'Download'. The log table has columns for Severity, Timestamp, Transition, Location, and Message.

State	Name	Location	Last Changed
	Transport Stream Not Present	Gateway Receive 3 (Gateway 3)	2012-01-17 05:16:48
	Transport SI		
	Transport SI		
	Transport SI		
	SRT Receiv		
	SRT Transm		
	RIST Recei		

Severity	Timestamp	Transition	Location	Message
	2021-05-07 07:55:...		Gateway Transmit 1 (Ga...	RIST Transmit Connection Error: Peer Create Failed.
	2021-05-07 07:55:...		Gateway Transmit 1 (Ga...	RIST Transmit Connection Error: None
	2021-05-07 07:55:...		Gateway Transmit 1 (Ga...	RIST Transmit Connection Error: Peer Create Failed.
	2021-05-07 07:55:...		Gateway Transmit 1 (Ga...	RIST Transmit Connection Error: None
	2021-05-07 07:55:...		Gateway Transmit 1 (Ga...	RIST Transmit Connection Error: Peer Create Failed.
	2021-05-07 07:55:...		Gateway Transmit 1 (Ga...	SRT Transmit Connection Error: The discovery timeout duration has elapsed.
	2021-05-07 07:54:...		Gateway Transmit 1 (Ga...	RIST Transmit Connection Error: None

Alarms

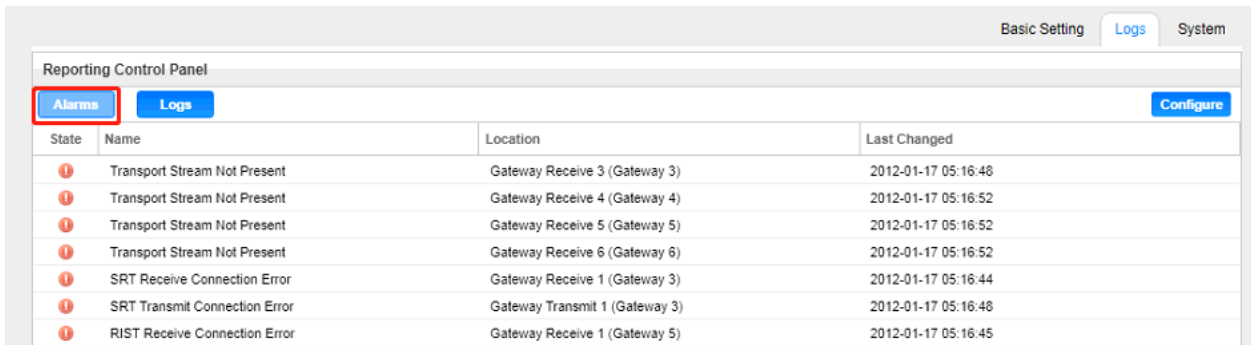

Clicking on the Alarms button displays the Active Alarms menu. This list displays all of the active alarms currently being reported by the unit. There are four columns in the log that display different types of information

Alarms	
Column Name	Description
State	<p>This area displays an icon that will signify the importance of the event</p> <p>The icon means the message is Informational and no error has been detected.</p> <p>The icon means the message is an Alarm and the unit status has been set to 'Error'</p>
Name	This column displays the description of the detected instance.
Location	This column displays the hardware or function that is experiencing the active error.
Last Changed	<p>This column displays the data and time the error was raised.</p> <p>Timestamps here are determined with the Date and Time settings configured in the Time tab under System Setting of the CMP baseboard</p>

Configuring the Alarms

The CP2-IP-00 module monitoring points are divided into Conditions and Events and are managed separately. Configuration of these is done by clicking on the configuration cog in either the Alarms or Logs window.

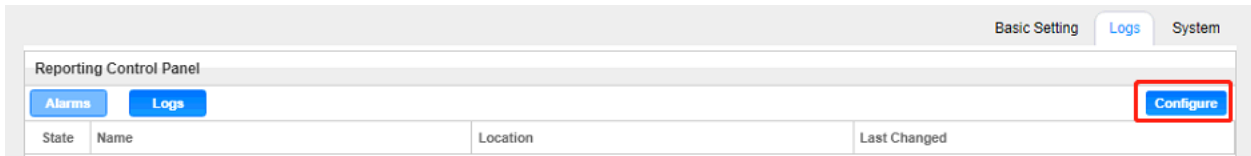

Conditions

These instances are monitored within specific hardware and stream processing paths. How the CP2-IP-00 module responds to the detection of the instance can be configured. Three 'checkbox' columns allow the user to define the system response. The checkbox at the top of the column can be used to enable or disable all instances in that column.

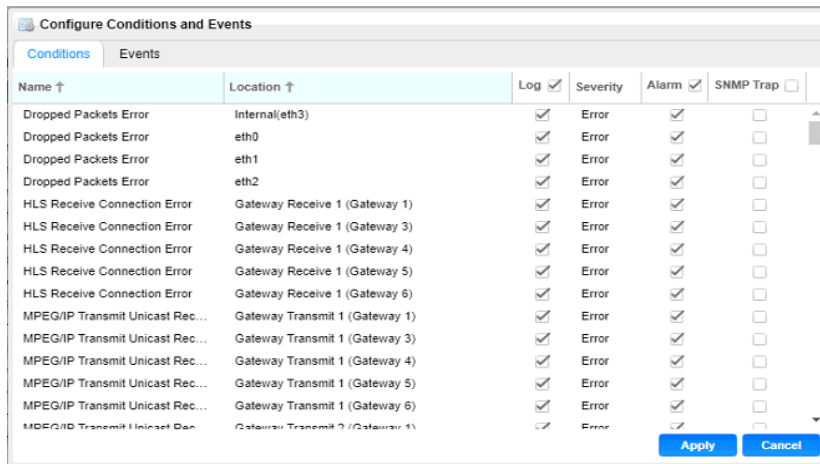

Logs

Column Name

Description

Name Defines the error message that will be provided if the instance is detected.

Location This shows the user the specific hardware or stream processing path where the instance is detected.

Log A checked box defines which instances will be recorded to the log file

Severity A dropdown box within the row allows the user to define the instance as an Error or Information event.

Alarm A checked box defines which instances will raise an Alarm condition on the unit. This will cause the Error LED on the front of the unit and

in the web client to illuminate.

SNMP Trap A checked box defines which instances will trigger the CP2-IP-00 to send trap messages.

The APPLY button at the bottom of the window will commit the settings changes to the system, while the CANCEL button will ignore any settings changes and close the configuration window.

Events

These instances are global to the system because they will have an impact on all hardware and stream processing areas of the CP2-IP-00 module. These instances can only be configured to be recorded in the log file and/or to be sent as SNMP Trap messages.

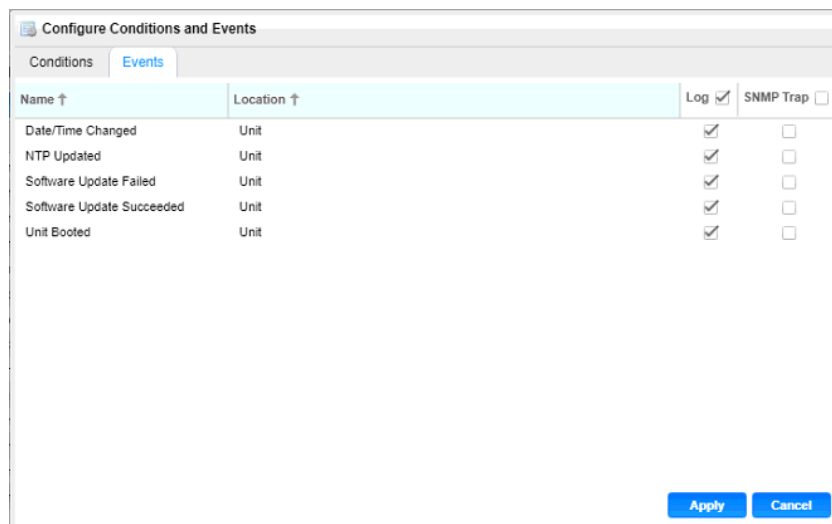

Events

Column Name	Description
Name	Defines the error message that will be provided if the instance is detected.
Location	This will always be "Unit" since these instances are global
Log	A checked box defines which instances will be recorded to the log file.
SNMP Trap	A checked box defines which instances will trigger the CP2-IP-00

module to send a trap message.

Event Logs

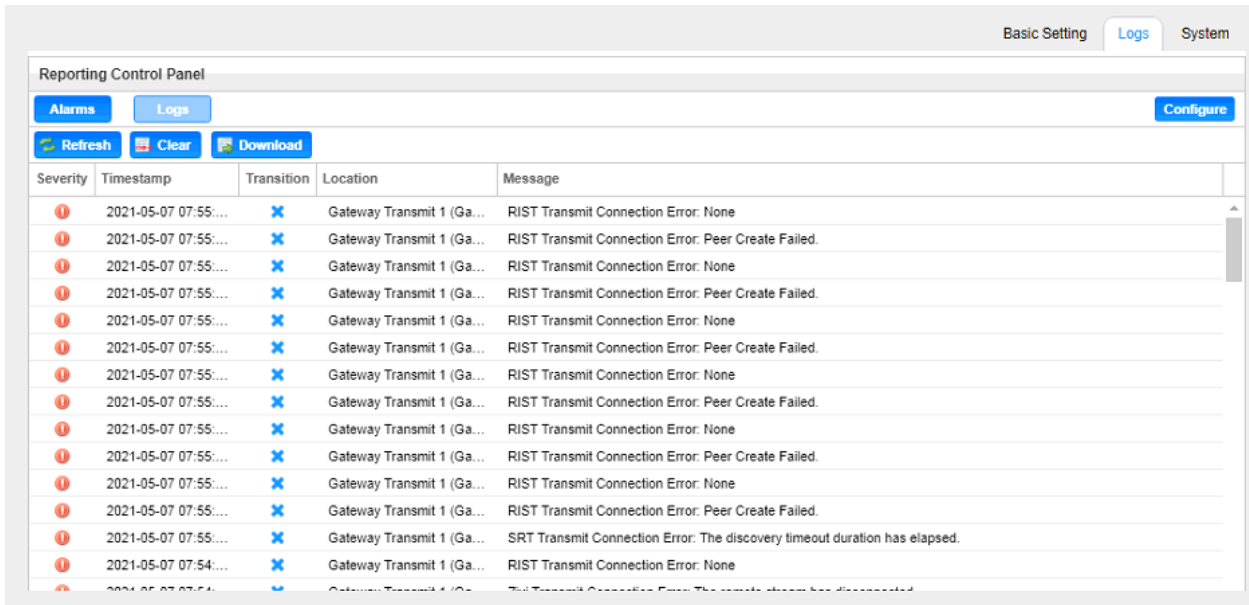

The Logs window provides the user a display of the log file and management tools to streamline the data returned. There are three buttons that will manage the log file.

Refresh



Prompts the CP2-IP-00 to update the displayed logs.

Clear







Clears the log file.

Download



Exports the log file as a “.csv” extension file to the pc.

The log file itself is made up of five columns that explain each event, when it occurred, and the area of the system where the event was detected.

Column Name	Description
Severity	<p>The  Info icon means the message is Informational and no error has been detected.</p> <p>The  Error icon means the message is an Alarm and the unit status has been set to 'Error'.</p>
Timestamp	This is the CP2-IP-00 module associated date and time of the instance.
Transition	<p>The  Went Bad icon means the instance entered into an Error state.</p> <p>The  Went Good icon means the instance entered into a Clear state.</p> <p>The  Event icon means a single point instance (such as NTP Time was updated) took place.</p>
Location	Defines the hardware or function that experienced the alarm or event.
Message	This displays the description of the specific path that experienced the instance.

Configuring the Logs

Configuration of the logs will provide the user with the same configuration options as covered in **the Configuration of the Alarms**.

CP2-IP-00 > System

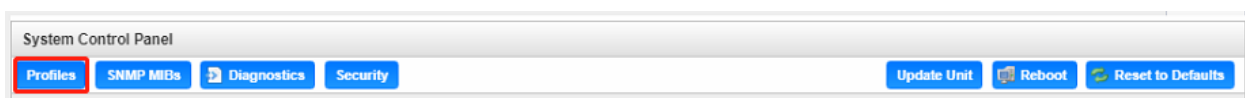

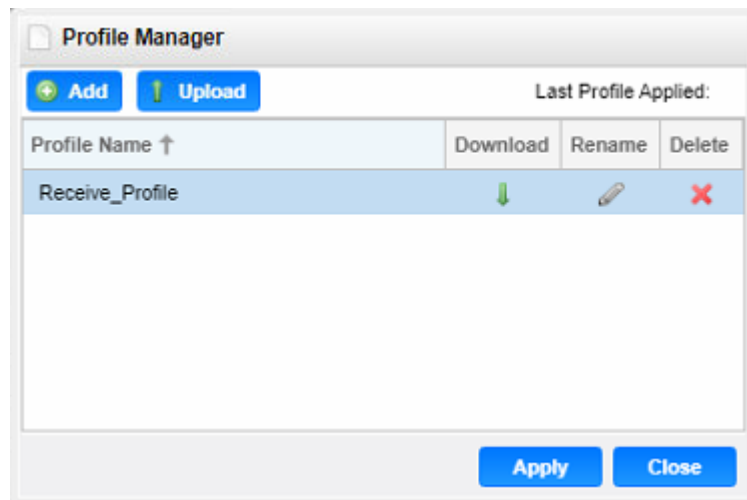

The CP2-IP-00 has the ability to save all configured settings to multiple profiles. Profiles can be saved locally, renamed and saved to external storage to be used on other CP2-IP-00 modules. Profiles can be used to quickly and easily change the configuration of the module to suit different inputs and decoding requirements.

Add New Profile



Used to create or add a new profile to the profile list

Upload Profile



Used to upload a profile to the module from the user pc

Apply Profile



Used to apply a profile selected from profile list

Rename Profile



Used to edit the selected profile name

Delete Profile



Used to delete a profile from the profiles list

Download Profile



Used to download a profile selected from the list to the user pc

SNMP MIB files

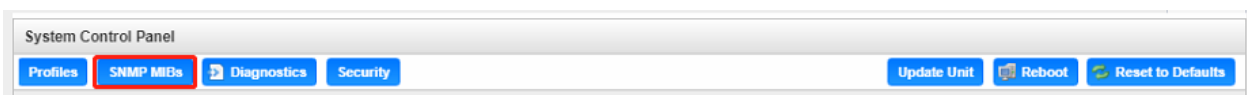

The SNMP MIB files for the CP2-IP-00 can be obtained by clicking on the SNMP MIBs button at the top of the page. This will open a new tab within the current web browser and give the user a list of all

available MIB files. Directions on how to save them to an external storage location are provided at the bottom of the list.

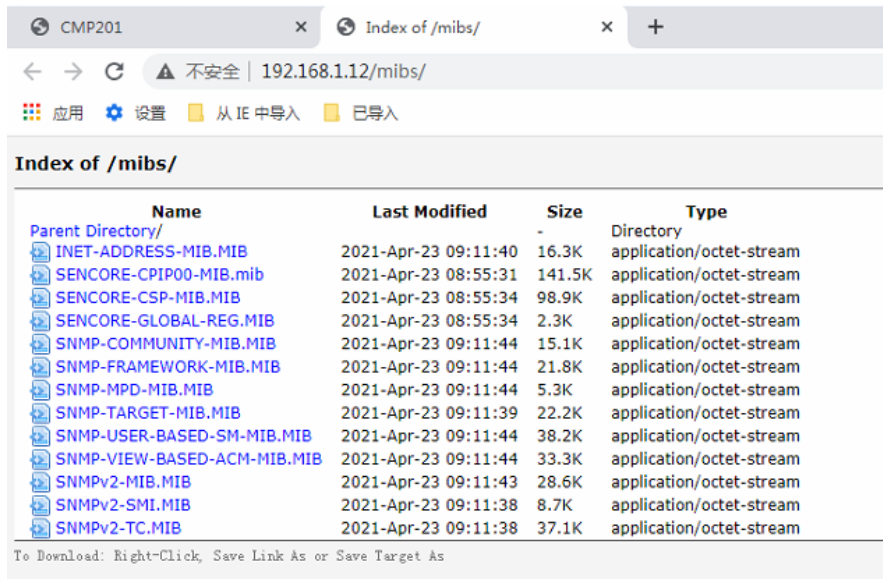

Diagnostics

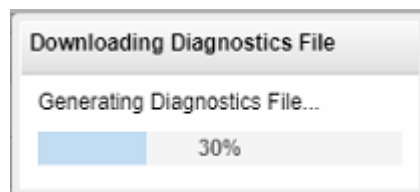

The CP2-IP-00 provides the user the ability to take a snapshot of the ALL current unit settings, reported values, active alarms, and the alarm and log file history. This snapshot will be downloaded as an .XML format file that can be attached in an email or opened for viewing.

Click the 'Diagnostics' button and a window will open showing the diagnostic file creation progress.

This window is replaced with a download file window when file creation is complete. The user will be asked to 'Open' or 'Save' the file. Selecting the Save option will download the .XML file to the pc 'downloads' location.

Security



The Security is used to configure self-signed certificate information.

Additionally, using public and private keys, this menu is used to enable DTLS encryption and decryption on RIST receive and transmit instances.

Security Manager

Certificate Signing Request

Country Name:

State or Province Name:

Locality Name:

Organization Name:

Organizational Unit Name:

Common Name:

Email Address:

Certificate Signing Request File Name:

Generate New CSR File:

Download Generate CSR File:

Delete Old CSR File:

Delete Old Local Private Key File:







Local Certificate File:

Local Private Key File:

Remote Certificate File:

Security Manager Menu

Settings	Range	Description
Name	User entry	Country Name for generated CSR file
State or Province Name	User entry	State/Province Name for generated CSR file

Locality Name	User entry	Locality Name for generated CSR file
Organization Name	User entry	Organization Name for the generated CSR file
Organizational Unit Name	User entry	Organizational Unit Name for the generated CSR file
Common Name	User entry	Common Name for the generated CSR file
Email Address	User entry	Email Address for reference on the generated CSR file
Generate New CSR File		This icon will generate a new Certificate Signing Request file (CSR) using the configured IP from eth0 for the CSR file name. Additionally, the Security Manager will generate a local private key file to be used with the downstream
Download Generate CSR File		This icon will download the locally generated CSR file onto a remote machine
Delete Old CSR File		This icon will delete the locally generated CSR file
Delete Old Local Private Key File		This icon will delete the locally generated private key file
Local Certificate File		Use this icon to upload the local certificate file
Local Private Key File		Use this icon to upload the local private key file
Remote Certificate File		Use this file to upload the remote certificate file

Upon clicking , the system will generate a new CSR file and local private key for use with the downstream receiver.

Certificate Signing Request File Name:	0.0.0.0.csr
Generate New CSR File:	<input type="button" value="Generate"/>
Download Generate CSR File:	<input type="button" value="Download"/>
Delete Old CSR File:	<input type="button" value="Delete"/>
Delete Old Local Private Key File:	<input type="button" value="Delete"/>
Local Certificate File:	<input type="button" value="Upload"/>
Local Private Key File:	private_key.pem <input type="button" value="Upload"/>
Remote Certificate File:	<input type="button" value="Upload"/>

Generated Private Key and CSR Files

Enabling DTLS

In order to make a successful DTLS connection when enabling encryption and decryption on RIST receive and transmit instances, a “Local Certificate File”, “Local Private Key File” and “Remote Certificate File” must be uploaded to the Security Manager.

As shown in the figure, the same Certificate File may be uploaded to both the Local and Remote Certificate File fields.

Local Certificate File:	<input type="button" value="Upload"/>
Local Private Key File:	private_key.pem <input type="button" value="Upload"/>
Remote Certificate File:	<input type="button" value="Upload"/>

Uploaded Key and Certificate Files

When making a DTLS connection between a CP2-IP-00 that is transmitting RIST and a CP2-IP-00 that is receiving RIST, these same files must be uploaded to both units. Additionally, both the output and input instance on each unit must have Profile Mode configured for “Main” and Encryption Mode configured for “DTLS”.

Updating the System Software

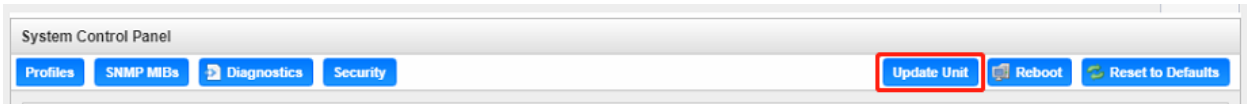



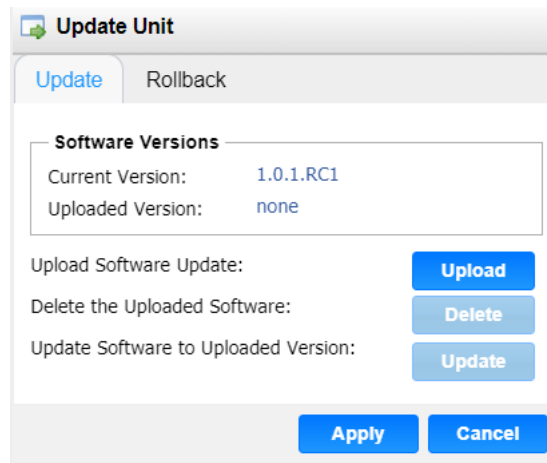

Updates to the CP2-IP-00 are performed through the web interface. A software update file is provided by Wellav and then uploaded to the unit. To request the latest software version or a copy of the release notes please contact our after-sales technical support team. The 'Update Unit' button is in the top right corner of the System Control Panel. When opened this feature will allow the user to advance the software version the CP2-IP-00 operates on, or rollback the software version that the module operates on.

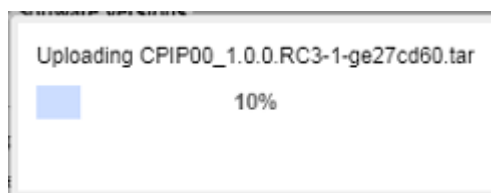

Applying software updates

1. Click Upload button and browse to the appropriate software file
2. A progress bar will show uploading status
3. Once the file is uploaded click on Yes when prompted to update
4. The module will reboot after a software update is complete.



Upload Software Update		To upload software updates to CP2-IP-00 module, click this button. The user will be prompted to navigate to an update file. The file will then upload to the module. When completed, the module will prompt the user to either apply the update or cancel
Delete the Uploaded Software		Clicking this button prompts the user to confirm the deletion of the software update from the CP2-IP-00 module. This will also clear the Uploaded Version status of the Software Versions section.
Update Software to Uploaded Version		Clicking the button starts the software update process. The CP2-IP-00 module will prompt the user to confirm the update. Click Yes to continue or No to cancel.

Rollback Software Updates

The CP2-IP-00 module is capable of reverting back to a previous version of software using the Rollback feature. The CP2-IP-00 accomplishes this by maintaining two separate software images; one is the most current version of software with all current settings and the other is the previous version of software with all of the previous settings. To perform a rollback, click the Update Unit button and then click the Rollback tab. The module will reboot after the rollback process is complete.

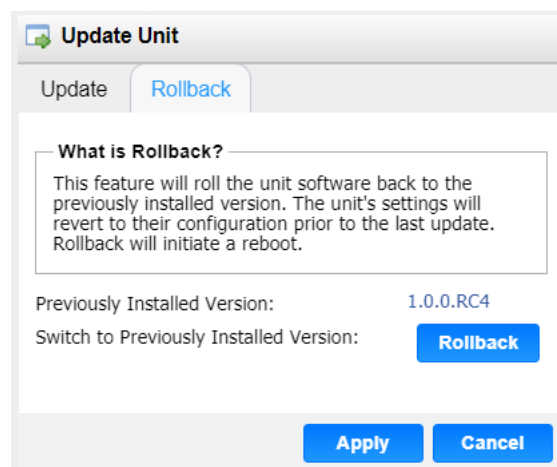

Reboot the Unit

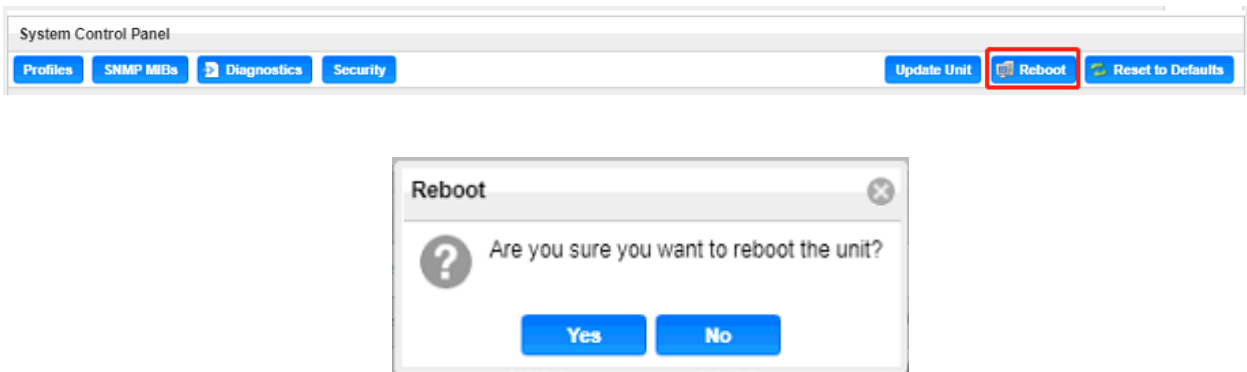

The CP2-IP-00 module can be rebooted from the web interface System page. The 'Reboot' button is located in the top right corner of the System Control Panel.

To perform a reboot, click the reboot button. The system will prompt the user to confirm the reboot request. Once confirmed, a status window with a progress bar will open and be visible until the reboot is complete and the login window displayed.

Reset to Defaults

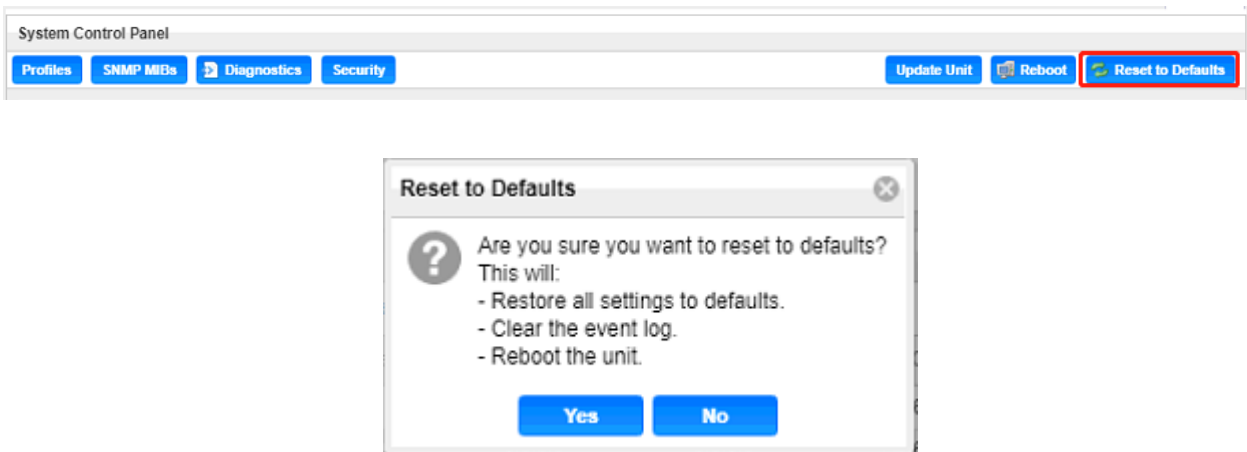

The CP2-IP-00 module settings can be reset to factory defaults. All settings will be returned to the factory defaults **except** the network management ports TCP/IP settings. All event logs will be cleared. To reset all settings to default, click the Reset to Defaults button on the System page. The module will prompt the user to confirm the reset.

Configuring the Unit Networks and VLANs

The CP2-IP-00 module can be assigned a Hostname and DNS servers. To access this menu, click on the Configure Networks gear icon. Within the window that opens, the user can assign a Hostname to the module, define which physical port (Eth0, Eth1, Eth2, Internal) the Default Gateway will use [The web-interface is accessible from the IP address of either Ethernet port; however, be sure to configure the two ports for separate subnets.], and provide addresses for Primary and Secondary Nameservers.

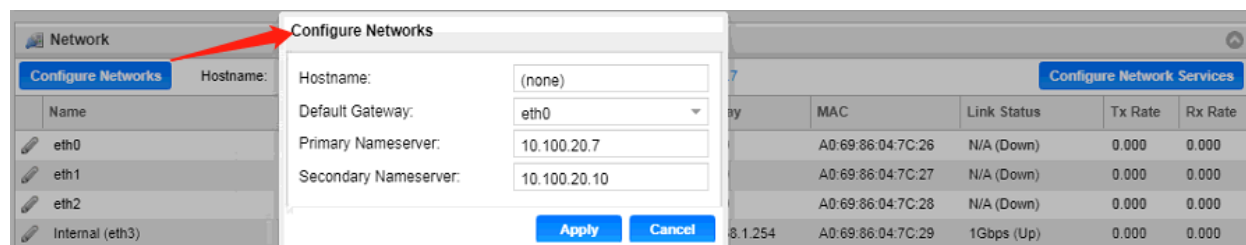

Setting	Available Selections	Descriptions
Hostname	Alphanumeric, no spaces allowed	Defines optional system name
Default Gateway	Eth0, Eth1, Eth2, Internal	Defines which physical port gateway address is to be used
Primary Nameserver	xxx.xxx.xxx.xxx	IP address of Primary (DNS) nameserver
Secondary Nameserver	xxx.xxx.xxx.xxx	IP address of Secondary (DNS) nameserver

Management and Video/IP Ports

Each of the three physical NICs and one internal NIC are identical in every way; either one can be configured for the management or Video/IP networks. As shown below, clicking the gear icon will open the settings for each NIC, including the name of the port, IP address and VLAN options. After finishing changes, click the apply button.

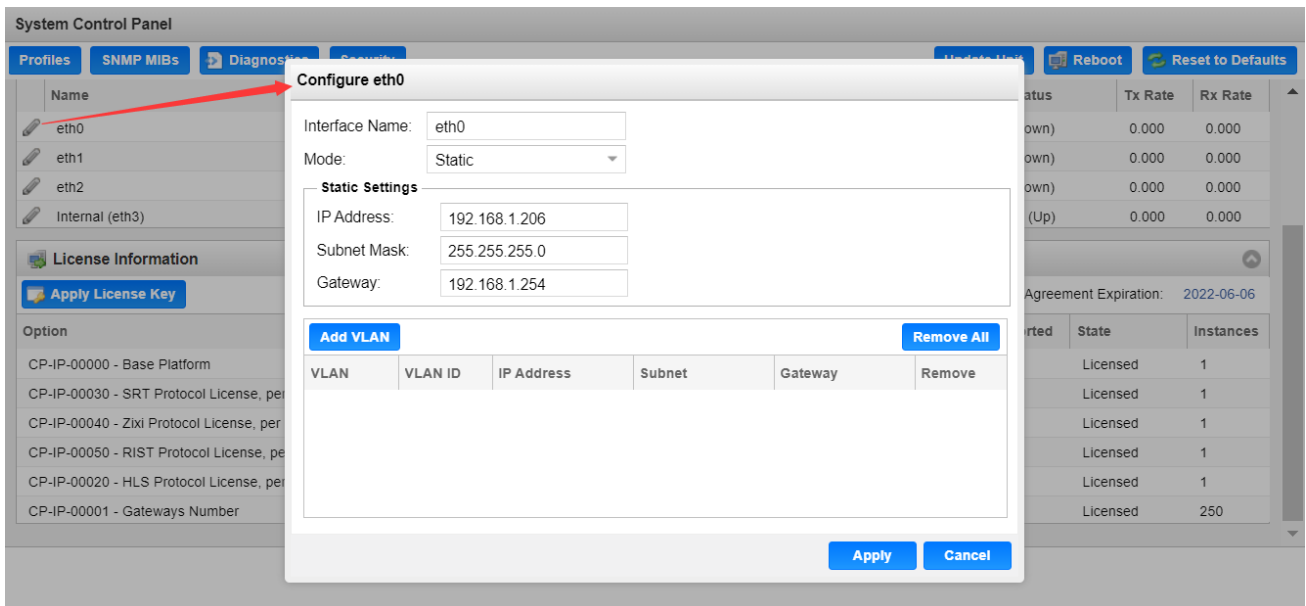

Setting	Available Selections	Descriptions
Interface Name	User Entered (eth0/eth1/eth2/Internal)	User defined port names
Mode	DHCP, Static	DHCP allows network server to provide IP address Static requires the user to define the IP address to be used
IP Address	xxx.xxx.xxx.xxx	Static mode IP address entry
Subnet Mask	xxx.xxx.xxx.xxx	Static Mode subnet mask entry
Gateway	xxx.xxx.xxx.xxx	Static Mode gateway entry

To add a VLAN to the NIC, click the  icon to bring up the “Add VLAN” menu as shown on the next page.

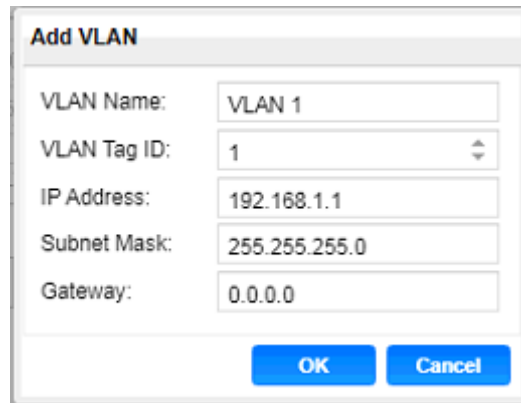



The 'Add VLAN' dialog box contains the following fields and values:

VLAN Name:	VLAN 1
VLAN Tag ID:	1
IP Address:	192.168.1.1
Subnet Mask:	255.255.255.0
Gateway:	0.0.0.0

Buttons: OK, Cancel

Setting	Available Selections	Descriptions
VLAN Name	User Entered	User defined VLAN names
VLAN Tag ID	1 - 4094	The VLAN tag to be assigned to outgoing streams and filtered for incoming streams
IP Address	xxx.xxx.xxx.xxx	Static mode IP address entry
Subnet Mask	xxx.xxx.xxx.xxx	Static Mode subnet mask entry
Gateway	xxx.xxx.xxx.xxx	Static Mode gateway entry

After clicking “OK” to finish configuring the newly created VLAN, it will appear on the VLAN list as seen in the figure below. To remove individual VLANs, click the blue  icon in the corresponding row. To remove all created VLANs, click the  button.

Configuring Network Services

Both Physical NICs can have specific features enabled for functionality or disabled for security. To configure these settings, click on  as indicated in the figure below.

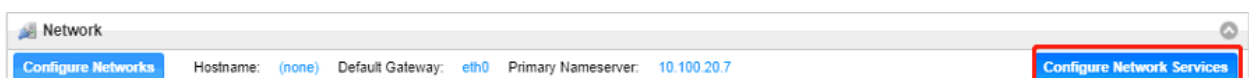

The “Configure Network Services” menu will then be shown. These are the default settings that allow for web access, ICMP contact through pinging and general stream input and output traffic. To enable or disable further settings, click to check the leftmost box as well as the box corresponding to the physical NIC (eth0, eth1, eth2, eth3) in the row of the intended service.

<input type="checkbox"/>	Service ↑	Protocol	Port	eth0 <input type="checkbox"/>	eth1 <input type="checkbox"/>	eth2 <input type="checkbox"/>	eth3 <input type="checkbox"/>
<input checked="" type="checkbox"/>	HTTP	TCP	80	<input checked="" type="checkbox"/>	<input checked="" type="checkbox"/>	<input checked="" type="checkbox"/>	<input checked="" type="checkbox"/>
<input checked="" type="checkbox"/>	ICMP	ICMP	N/A	<input checked="" type="checkbox"/>	<input checked="" type="checkbox"/>	<input checked="" type="checkbox"/>	<input checked="" type="checkbox"/>
<input type="checkbox"/>	SNMP	UDP	161	<input type="checkbox"/>	<input type="checkbox"/>	<input type="checkbox"/>	<input type="checkbox"/>
<input type="checkbox"/>	SNMP Traps	UDP	162	<input type="checkbox"/>	<input type="checkbox"/>	<input type="checkbox"/>	<input type="checkbox"/>
<input checked="" type="checkbox"/>	SSH	TCP	22	<input checked="" type="checkbox"/>	<input checked="" type="checkbox"/>	<input checked="" type="checkbox"/>	<input checked="" type="checkbox"/>
<input checked="" type="checkbox"/>	Stream I/O	N/A	N/A	<input checked="" type="checkbox"/>	<input checked="" type="checkbox"/>	<input checked="" type="checkbox"/>	<input checked="" type="checkbox"/>
<input type="checkbox"/>	Syslog	UDP	514	<input type="checkbox"/>	<input type="checkbox"/>	<input type="checkbox"/>	<input type="checkbox"/>

Service	Protocol	Port	Descriptions
HTTP	TCP	80	Allows access to the web interface via browser
ICMP	ICMP	N/A	Allows access to ICMP responses (such as pinging)
SNMP	UDP	161	Allows SNMP GET/SET commands
SNMP Traps	UDP	162	Enables SNMP traps to send upon system change
SSH	TCP	22	Allows for SSH access through port 22
Stream I/O	Unknown	N/A	Enables and disables all stream traffic for the physical interface (Zixi, MPEG/IP, SRT, HLS)
Syslog	UDP	514	Allows configuration of a syslog server for state triggered messages.

License Information

Certain features of the CP2-IP-00 require licenses in order to be functional. The interface displays all licenses available as well as the following status:

- License Locked or Unlocked
- License is Supported or Unsupported by the installed hardware

If licenses need to be applied to the module, click Apply License Key button. The menu below will appear where the user can copy and paste the provided license key from Wellav.

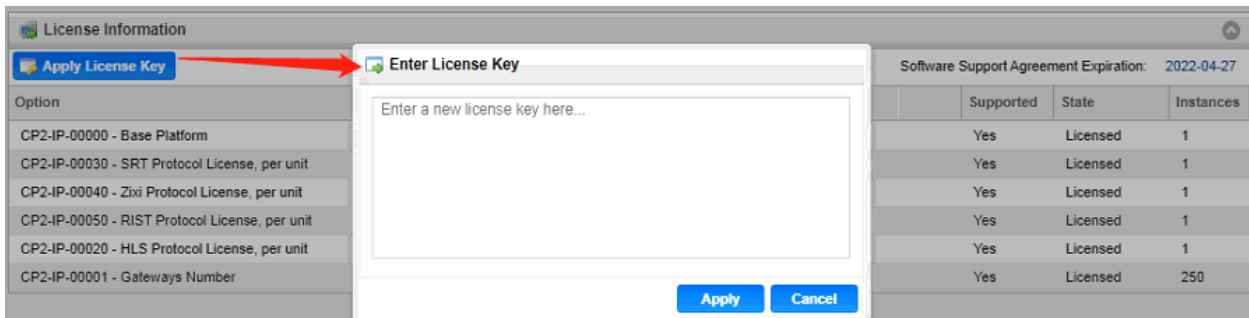

The screenshot shows the 'License Information' window. On the left, there is a list of license options. A red arrow points from the 'Apply License Key' button to the 'Enter License Key' dialog box. The dialog box contains a text input field with the placeholder text 'Enter a new license key here...' and 'Apply' and 'Cancel' buttons. On the right, there is a table showing license details and a 'Software Support Agreement Expiration' date of 2022-04-27.

	Supported	State	Instances
CP2-IP-00000 - Base Platform	Yes	Licensed	1
CP2-IP-00030 - SRT Protocol License, per unit	Yes	Licensed	1
CP2-IP-00040 - Zbx Protocol License, per unit	Yes	Licensed	1
CP2-IP-00050 - RIST Protocol License, per unit	Yes	Licensed	1
CP2-IP-00020 - HLS Protocol License, per unit	Yes	Licensed	1
CP2-IP-00001 - Gateways Number	Yes	Licensed	250

5.4.6 CP-IP-02

CP-IP-02 is a Gigabit IP multiplexing processing module, with 2 RJ45 Gigabit port, support UDP/RTP protocol, the single port maximum support 120 channels input and 120 channels output



Click the **IP Input** in the menu to go into IP input page where you can see **Status**, **Basic Setting**, **IGMP Setting** and **Service Configuration**.

Channel	IP Address : Port	Effective Bitrate(Mbps)	Total Bitrate(Mbps)	TS Analysis	Service List
1.1	227.30.30.1 : 10001	3.726	3.726		
1.2	227.30.30.2 : 10002	3.726	3.726		
1.3	227.30.30.3 : 10003	3.716	3.716		
1.4	227.30.30.4 : 10004	3.716	3.716		
1.5	227.30.30.5 : 10005	3.716	3.716		
1.6	227.30.30.6 : 10006	3.716	3.716		
1.7	227.30.30.7 : 10007	3.716	3.716		
1.8	227.30.30.8 : 10008	3.716	3.716		
1.9	227.30.30.9 : 10009	3.716	3.716		
1.10	227.30.30.10 : 10010	3.716	3.716		
1.11	227.30.30.11 : 10011	3.716	3.716		

IP Input >Status

In this page, you can check info of each channel: Total Bit Rate, Effect Bit Rate, TS Analysis and Service List.

Channel	IP Address : Port	Effective Bitrate(Mbps)	Total Bitrate(Mbps)	TS Analysis	Service List
1.1	227.30.30.1 : 10001	3.726	3.726		
1.2	227.30.30.2 : 10002	3.726	3.726		
1.3	227.30.30.3 : 10003	3.716	3.716		
1.4	227.30.30.4 : 10004	3.716	3.716		
1.5	227.30.30.5 : 10005	3.716	3.716		
1.6	227.30.30.6 : 10006	3.716	3.716		
1.7	227.30.30.7 : 10007	3.716	3.716		
1.8	227.30.30.8 : 10008	3.716	3.716		
1.9	227.30.30.9 : 10009	3.716	3.716		
1.10	227.30.30.10 : 10010	3.716	3.716		
1.11	227.30.30.11 : 10011	3.716	3.716		

Click the icon () in the **TS Analysis** list to see the TS analyzing result of each channel. Click the icon () in the **Service List** to see the Services of each channel.

- **TS Analysis**

Click **Reset Counter** to clear continuity count errors and restart counting. Fill in the search bar with key words of PID / Bit rate / bandwidth / table type / service name to get info you want.

Channel1.1 TS Analysis Reset Counter

Search

PID	Bit Rate(Mbps)	Bandwidth(%)	Continuity Count Error	Type	Service
0x0(0)	0.001	0.085	0	PAT	
0x11(17)	0.001	0.085	0	SDT	
0x102(258)	0.001	0.085	0	Other	
0x103(259)	0.001	0.085	0	Other	
0x201(513)	0.269	22.816	0	Other	
0x202(514)	0.242	20.526	0	Other	
0x294(660)	0.021	1.781	0	Other	
0x29e(670)	0.021	1.781	0	Other	

Tips:

- Service List

Click a service name to check its detailed info.

Channel : 1.1

#	Service
1	[302] CCTV 2
2	[303] CCTV 7

[302] CCTV 2

Type	PID	Bit Rate(Mbps)
PCR	8190	0.044
PMT	258	0.018
Video(MPEG2)	513	4.899
Audio	660	0.256

Close

IP Input >Basic Settings

Here you can configure IP input parameters: **Destination IP Address**, **Destination Port**, **Protocol** (UDP/RTP),and **TS Packets Per IP Packet**. Click **Apply** to make the setting take effect.

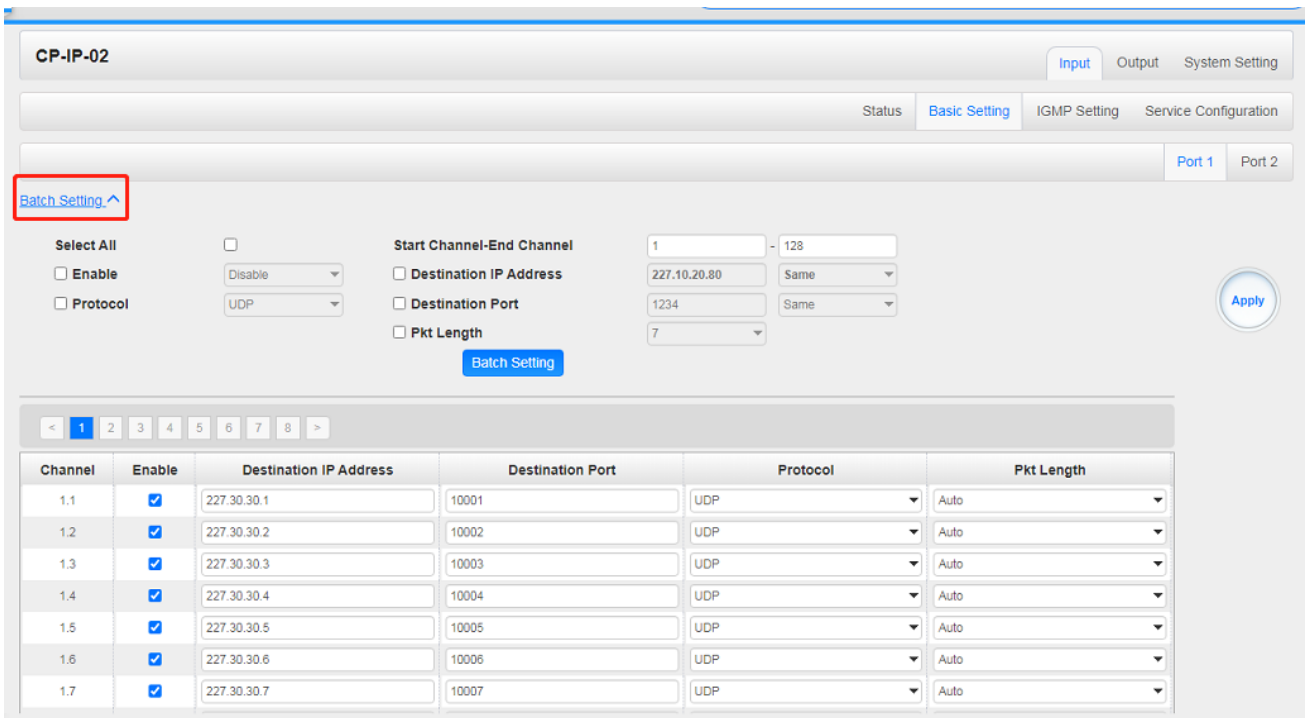

If you want to configure a batch of channels, please click **Batch Setting**

To set the IP input parameters in batch, you can check the boxes before parameters you need then choose / modify the values.. Click **Apply** to make the setting take effect.

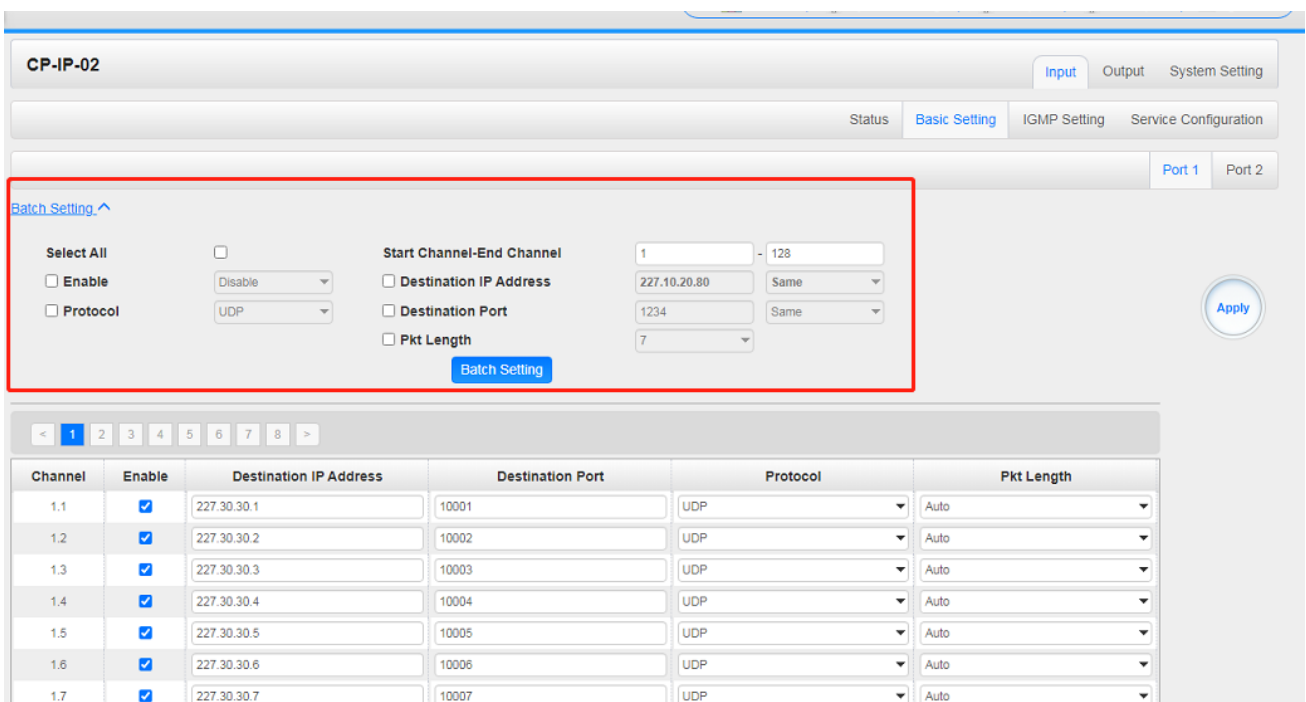

IP Input >IGMP Setting

In this tab, user can choose **IGMP version**, **IGMP Automatic Report**, and **IGMP Report Cycle(s)**.

CP-IP-02

Input Output System Setting

Status Basic Setting **IGMP Setting** Service Configuration

IGMP Version: V2

IGMP Automatic Report: Enable

IGMP Report Cycle(s): 15

Apply

IP Input >Service Configuration

To stream a source stream, you can configure the destination in this page.

CP-IP-02

Input Output System Setting

Status Basic Setting IGMP Setting **Service Configuration**

Port 1 Port 2

Channel Select : Channel 1.1 Scanning Time(ms) : 1000 Program Scan

Service Name	Destination	Destination Setting
Channel 1.1 +	3.CP-IP-02[1.1]	⚙️
[713] Bloomberg European TV		✍️
PID 1 (CAT)		✍️
Channel 1.2 +	3.CP-IP-02[1.2]	⚙️
[713] Bloomberg European TV		✍️
PID 1 (CAT)		✍️
Channel 1.3 +	3.CP-IP-02[1.3]	⚙️
[713] Bloomberg European TV		✍️
PID 1 (CAT)		✍️
Channel 1.4 +	3.CP-IP-02[1.4]	⚙️
[713] Bloomberg European TV		✍️
PID 1 (CAT)		✍️
Channel 1.5 +	3.CP-IP-02[1.5]	⚙️

Apply

Clear Config

- Multiplex or Bypass stream: Click the setting icon (⚙️), check the output module, and then you can set the output channel of this stream. After you select bypass mode, this output channel will be occupied only by this stream.
- Multiplex services: You should click the service line setting icon (✍️) to make the certain service output from certain channel combining with other services. The operation you can refer to multiplex stream output.

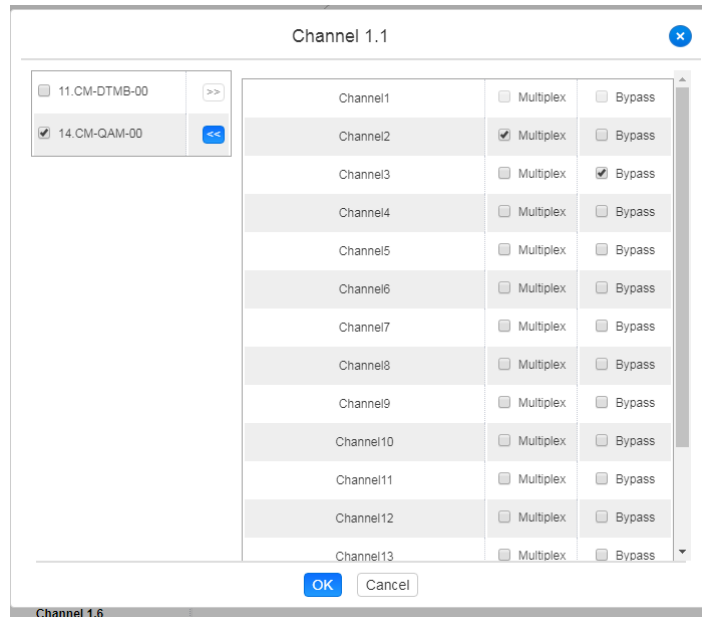

After setting the output destination, click **Apply** to make it take effect. The destination channel will be displayed in the channel/service line. And you can also click **Clear Configuration** to clear all of the configuration.



There is a channel scan button (Channel Scan) on top. Normally the input service list of each channel will load itself on this page, but when you change the input source, the list could not refresh immediately. You can refresh the changed channels manually by selecting the channel and clicking the channel scan button.

IP Output >Status

The IP output status information you can check on this page is similar to that of IP input. The TS analysis and service list function are also available.

Channel	IP Address : Port	Effective Bitrate(Mb...	Total Bitrate(Mbps)	Bitrate	TS Analysis	Service List
1.1	227.20.1.1 : 1234	3.747	5.000	Normal	👁	📄
1.2	227.20.1.2 : 1234	3.747	5.000	Normal	👁	📄
1.3	227.20.1.3 : 1234	3.747	5.000	Normal	👁	📄
1.4	227.20.1.4 : 1234	3.737	5.000	Normal	👁	📄
1.5	227.20.1.5 : 1234	3.747	5.000	Normal	👁	📄
1.6	227.20.1.6 : 1234	3.747	5.000	Normal	👁	📄
1.7	227.20.1.7 : 1234	3.758	5.000	Normal	👁	📄
1.8	227.20.1.8 : 1234	3.758	5.000	Normal	👁	📄
1.9	227.20.1.9 : 1234	3.747	5.000	Normal	👁	📄
1.10	227.20.1.10 : 1234	3.737	5.000	Normal	👁	📄
1.11	227.20.1.11 : 1234	3.747	5.000	Normal	👁	📄
1.12	227.20.1.12 : 1234	3.737	5.000	Normal	👁	📄
1.13	227.20.1.13 : 1234	3.737	5.000	Normal	👁	📄
1.14	227.20.1.14 : 1234	3.758	5.000	Normal	👁	📄

IP Output >Basic Settings

Setting IP output channels is also similar to Setting IP input.

Batch Setting

Select All
 Enable
 Source Port
 Protocol
 Bitrate(Mbps)

Start Channel-End Channel
 Destination IP Address
 Destination Port
 Pkt Length
 Enable Destination MAC

TX Interval: 100 (ms)

Channel	Enable	Source Port	Destination IP Ad...	Destination Port	Protocol	Pkt Length	Bitrate(...)	Enable Destination MAC	Destination MAC
1.1	<input checked="" type="checkbox"/>	1000	227.20.1.1	1234	UDP	7	5	Disable	01:00:5E:14:01:01
1.2	<input checked="" type="checkbox"/>	1000	227.20.1.2	1234	UDP	7	5	Disable	01:00:5E:14:01:02
1.3	<input checked="" type="checkbox"/>	1000	227.20.1.3	1234	UDP	7	5	Disable	01:00:5E:14:01:03
1.4	<input checked="" type="checkbox"/>	1000	227.20.1.4	1234	UDP	7	5	Disable	01:00:5E:14:01:04

- Multicast output setting: You should fill the fit multicast IP addresses as output in the **Destination IP Address** box. **Please avoid IP confliction among baseboard, encoder modules (see encoder modules page) and other devices when you set the multicast output.**
- Unicast output setting: You should fill the unicast receiving end’s IP addresses in the **Destination IP Address** box.
- Destination MAC: Normally you do not need to enable the Destination MAC switch. Only in some specific case where the unicast stream cannot be received due to unknown reasons, you

should enable Destination MAC and fill in the correct receiver MAC in instead of using unicast IP addresses.



Constant Rate of any output channel/TS/port ought to be set manually about 2 Mbps higher than the **Effective Bit rate** in the corresponding output channel/TS/port, since the **Effective Bit rate** might fluctuates a little bit. If you set the **Constant Rate** much higher that the **Effective Bit rate**, there will be lots of null packets in the output transport stream.

If you want to configure a batch of channels, please click **Batch Setting**.

Batch Setting of IP output channels is also similar to that of IP input.

IP Output
Status **Basic Setting** Service Configuration PSIP

[Batch Setting ^](#)

Select All

Enable Disable

Source Port 1000

Protocol UDP

Bitrate 25 (Mbps)

Start Channel-End Channel 1 - 120

Destination IP Address 227.10.20.80 Same

Destination Port 1234 Same

Pkt Length 7

Enable Destination MAC Disable AA:BB:CC:DD:EE:FF

Batch Setting

Apply

TX Interval: (ms)

<
1
2
3
4
5
6
7
8
>

Channel	Enable	Source Port	Destination IP A...	Destination ...	Protocol	Pkt Length	Bitrate(...)	Enable Destination MAC	Destination MAC
1.1	<input checked="" type="checkbox"/>	1000	239.168.10.20	10000	UDP	7	15	Disable	01:00:5E:28:0A:14
1.2	<input checked="" type="checkbox"/>	1000	239.168.10.30	10000	UDP	7	15	Disable	01:00:5E:28:0A:1E
1.3	<input type="checkbox"/>	1000	227.10.20.3	1234	UDP	7	15	Disable	00:00:00:00:00:00
1.4	<input type="checkbox"/>	1000	227.10.20.4	1234	UDP	7	15	Disable	00:00:00:00:00:00
1.5	<input type="checkbox"/>	1000	227.10.20.5	1234	UDP	7	15	Disable	00:00:00:00:00:00

IP Output >Service Configuration

You can make configuration for output services and TS.

CP-IP-02

Input Output System Setting

Status Basic Setting Service Configuration

Port 1 Port 2

Click "Apply" after modifying your parameters to save the configuration.

[1.1] TS 3.1.1

1. Bloomberg European TV

[1.2] TS 3.1.2

1. Bloomberg European TV

[1.3] TS 3.1.3

1. Bloomberg European TV

[1.4] TS 3.1.4

1. Bloomberg European TV

[1.5] TS 3.1.5

1. Bloomberg European TV

[1.6] TS 3.1.6

1. Bloomberg European TV

[1.1] TS

Original Network ID 1337

TS ID 30

NO.	Service ID	Service Name	Service Provider
1	713	Bloomberg European TV	Arqiva

Other PIDs

1

Apply Clear Config

OK Cancel

- TS setting: Click TS line (the blue area) to configure Original Network ID, TS ID and each Service ID, Service Name, and Service Provider.
- NIT setting: Please refer to CM-QAM-00 module.

5.5 Transcode Modules

5.5.1 CX-TXS-00

CX-TXS-00 is a transcoder module that supports transcoding between different video compression standards such as H.265, H.264 and MPEG-2. The module has 2 GbE ports, 2 USB ports and 1 HDMI port. The GbE ports will be used for IP stream input and output while USB port and HDMI port will be used for OS installation.

With this transcoder module, you're able to output programs with desired codec to adapt to various decoder terminals and/or further transmission.

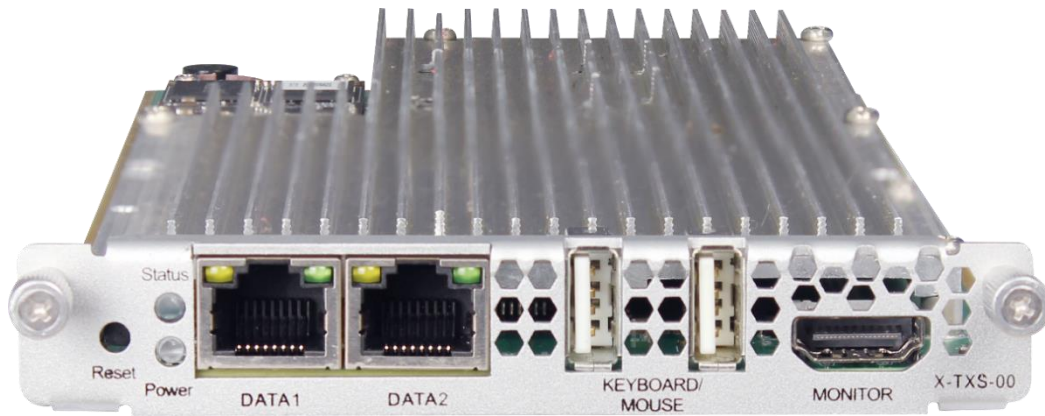

CX-TXS-00 >Status

Status allows the user to have an overview about the details of current status and media info of input and output. User could drag the bar below to see more info.

CX2-TXS-00									
Status Input Engine System Alarm About									
Advanced Setting									
Engine	Status	Run Time	Input			Output URL	Preview	Encoding Format	
			Input Source	Service	View				
1	●	0:0:0:27	UDP://239.192.10.201:10000:Data 2	[1]	👁	UDP://239.168.0.10:6001		MPEG-2	
2	●	0:0:0:0	UDP://0.0.0.0:5001:Internal	[1] NONE	👁	UDP://0.0.0.0:6002		MPEG-2	
3	●	0:0:0:0	UDP://0.0.0.0:5001:Internal	[1] NONE	👁	UDP://0.0.0.0:6003		MPEG-2	
4	●	0:0:0:0	UDP://0.0.0.0:5001:Internal	[1] NONE	👁	UDP://0.0.0.0:6004		MPEG-2	
5	●	0:0:0:0	UDP://0.0.0.0:5001:Internal	[1] NONE	👁	UDP://0.0.0.0:6005		MPEG-2	
6	●	0:0:0:0	UDP://0.0.0.0:5001:Internal	[1] NONE	👁	UDP://0.0.0.0:6006		MPEG-2	
7	●	0:0:0:0	UDP://0.0.0.0:5001:Internal	[1] NONE	👁	UDP://0.0.0.0:6007		MPEG-2	
8	●	0:0:0:0	UDP://0.0.0.0:5001:Internal	[1] NONE	👁	UDP://0.0.0.0:6008		MPEG-2	

CX2-TXS-00									
Status Input Engine System Alarm About									
Advanced Setting >									
Output									
View	Output URL	Preview	Encoding Format	Resolution	Frame Rate	Total Bitrate(Mbps)	Video Bitrate(Mbps)	Audio1 Codec	
	UDP://239.168.0.10:6001		MPEG-2	1920 x 1080	Auto	8.80(Mbps)	8.00(Mbps)	MPEG1/L2	
	UDP://0.0.0.0:6002		MPEG-2	1920 x 1080	Auto	8.80(Mbps)	8.00(Mbps)	MPEG1/L2	
	UDP://0.0.0.0:6003		MPEG-2	1920 x 1080	Auto	8.80(Mbps)	8.00(Mbps)	MPEG1/L2	
	UDP://0.0.0.0:6004		MPEG-2	1920 x 1080	Auto	8.80(Mbps)	8.00(Mbps)	MPEG1/L2	
	UDP://0.0.0.0:6005		MPEG-2	1920 x 1080	Auto	8.80(Mbps)	8.00(Mbps)	MPEG1/L2	
	UDP://0.0.0.0:6006		MPEG-2	1920 x 1080	Auto	8.80(Mbps)	8.00(Mbps)	MPEG1/L2	
	UDP://0.0.0.0:6007		MPEG-2	1920 x 1080	Auto	8.80(Mbps)	8.00(Mbps)	MPEG1/L2	
	UDP://0.0.0.0:6008		MPEG-2	1920 x 1080	Auto	8.80(Mbps)	8.00(Mbps)	MPEG1/L2	

- **Engine:** Show channel number. The amount of input channels is controlled by license.
- **Status:** Show channel status. When channel is on, it will show green light. Otherwise, it will show red light.
- **Input Source:** Show channel input protocol, address and port, and input Ethernet.
- **Service:** Show which channel is being transcoding.
- **View:** Click to see detailed info of selected input channel
- **Output URL:** Show output protocol, address and port number.
- **Preview:** Preview transcoding effect by moving the cursor over them.
- **Encoding format:** Show output encoding format.
- **Resolution:** Show output video resolution.
- **Frame rate:** Show output video frame rate.
- **Total bitrate:** Show total output ts bitrate.
- **Video bitrate:** Show output video bitrate.
- **Audio bitrate:** Show output audio bitrate.
- **Run time:** Display how long the transcoding has been run.

User could also click the **Advanced Setting** on Status and users could select more/less parameters they want to display on Status.

CX2-TXS-00 Status Input Engine System Alarm About

Advanced Setting

Video Parameter

<input checked="" type="checkbox"/> Encoding Format	<input checked="" type="checkbox"/> Resolution	<input checked="" type="checkbox"/> Frame Rate	<input checked="" type="checkbox"/> Total Bitrate
<input checked="" type="checkbox"/> Video Bitrate	<input type="checkbox"/> Video Quality		

Audio Parameter

<input checked="" type="checkbox"/> Audio1 Codec	<input type="checkbox"/> Audio2 Codec	<input type="checkbox"/> Audio3 Codec	<input type="checkbox"/> Audio4 Codec
<input type="checkbox"/> Audio1 Bitrate	<input type="checkbox"/> Audio2 Bitrate	<input type="checkbox"/> Audio3 Bitrate	<input type="checkbox"/> Audio4 Bitrate
<input type="checkbox"/> Audio1 Sample Rate	<input type="checkbox"/> Audio2 Sample Rate	<input type="checkbox"/> Audio3 Sample Rate	<input type="checkbox"/> Audio4 Sample Rate

CX-TXS-00 >Input

This menu allows the user to configure the source input including UDP and RTP protocols. Based upon the type of protocol the user selects, the available configuration settings will adapt to provide the best fit.



Three settings that are common to all protocols are “Enable”, when user click the blank box would enable the channel; “Network Port”, which can be set to DATA1, DATA2 and Internal (CMP baseboard IP input) and “VLAN”, which will filter incoming streams for VLAN tags. If user select “Internal”, the module would use the CMP baseboard data port while user need to type the same IP address that use at IP input.

After finishing the configuration for all the parameters, click  to make the configuration take effect.

CX2-TXS-00 Status Input Engine System Alarm About

Engine	Status	Enable	Network Port	Protocol	IP Address	Port	VLAN	VLAN ID	Action
1	●	<input checked="" type="checkbox"/>	Data 1	UDP	239.192.10.201	10000	Disable	None	
2	●	<input type="checkbox"/>	Internal	UDP	0.0.0.0	5002	Disable	None	
3	●	<input type="checkbox"/>	Internal	UDP	0.0.0.0	5003	Disable	None	
4	●	<input type="checkbox"/>	Internal	UDP	0.0.0.0	5004	Disable	None	
5	●	<input type="checkbox"/>	Internal	UDP	0.0.0.0	5005	Disable	None	
6	●	<input type="checkbox"/>	Internal	UDP	0.0.0.0	5006	Disable	None	
7	●	<input type="checkbox"/>	Internal	UDP	0.0.0.0	5007	Disable	None	
8	●	<input type="checkbox"/>	Internal	UDP	0.0.0.0	5008	Disable	None	
9	●	<input type="checkbox"/>	Internal	UDP	0.0.0.0	5009	Disable	None	
10	●	<input type="checkbox"/>	Internal	UDP	0.0.0.0	5010	Disable	None	



Settings	Range	Description
Input	After finish settings of that input channel, check the box under to enable that input	A green indicator  beside means receive source successfully while a red  indicator means failed.
Network Interface	DATA1 DATA2 Internal	Select right Ethernet which the stream feeds into. The Internal input is fed by CMP baseboard Data port.
Protocol	UDP RTP	Check the "IP address" and enter Ethernet IP address which the source comes from.

CX-TXS-00 > Engine

After finishing configure the Input, user need to enter the Engine page to configure the transcoded parameters. This menu allows user to configure parameters of transcoded outputs.

Click the box at "Select Service" and select active input stream from drop-down list. User could

configure the transcoding output parameters at the box for the relevant channel. click  to make the configuration take effect.

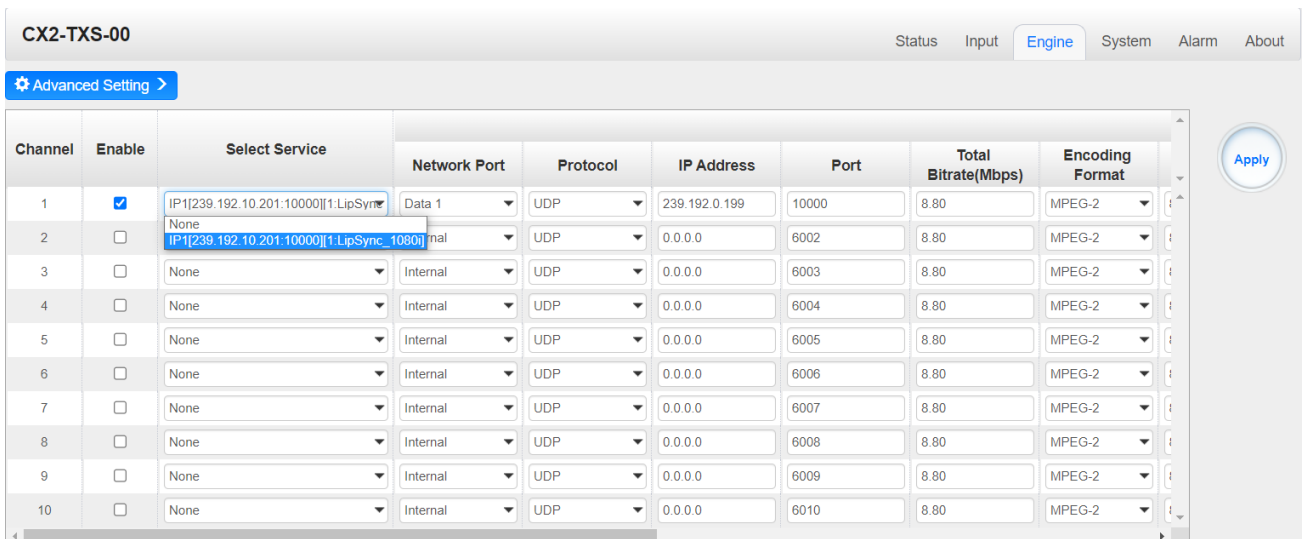

Channel	Enable	Select Service	Network Port	Protocol	IP Address	Port	Total Bitrate(Mbps)	Encoding Format
1	<input checked="" type="checkbox"/>	IP[239.192.10.201:10000][1:LipSync]	Data 1	UDP	239.192.0.199	10000	8.80	MPEG-2
2	<input type="checkbox"/>	None	Internal	UDP	0.0.0.0	6002	8.80	MPEG-2
3	<input type="checkbox"/>	None	Internal	UDP	0.0.0.0	6003	8.80	MPEG-2
4	<input type="checkbox"/>	None	Internal	UDP	0.0.0.0	6004	8.80	MPEG-2
5	<input type="checkbox"/>	None	Internal	UDP	0.0.0.0	6005	8.80	MPEG-2
6	<input type="checkbox"/>	None	Internal	UDP	0.0.0.0	6006	8.80	MPEG-2
7	<input type="checkbox"/>	None	Internal	UDP	0.0.0.0	6007	8.80	MPEG-2
8	<input type="checkbox"/>	None	Internal	UDP	0.0.0.0	6008	8.80	MPEG-2
9	<input type="checkbox"/>	None	Internal	UDP	0.0.0.0	6009	8.80	MPEG-2
10	<input type="checkbox"/>	None	Internal	UDP	0.0.0.0	6010	8.80	MPEG-2

Move the bar below to change the transcode output parameters.

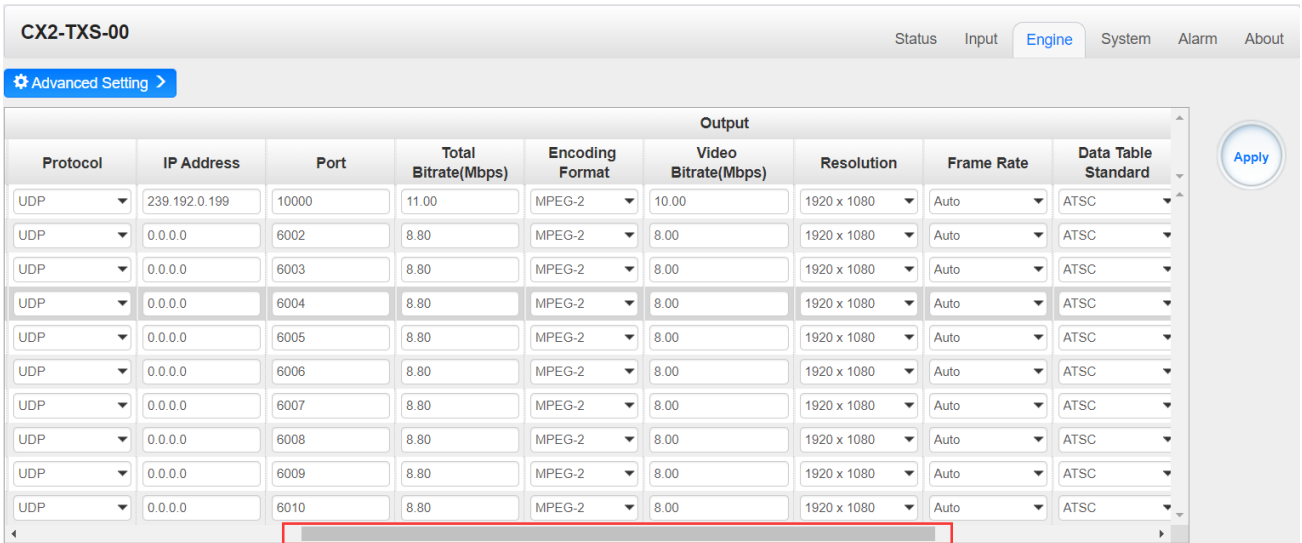

User could click  for more parameters to configure. User could click the box to add the feature inside the engine setting. If user click the box near the “Video/audio/Subtitle Parameter”, it would select all the features and add into the engine setting.

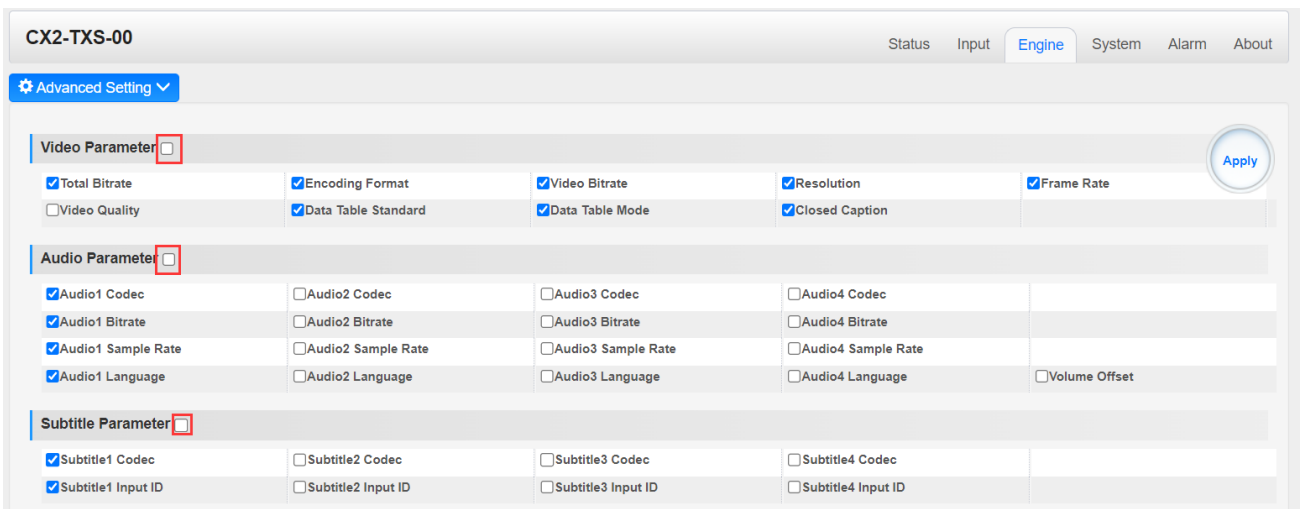

Transcode

Transport protocol

CX-TXS-00 supports transport with the following protocols: UDP, RTP, RTP with SDP.

1. UDP

Settings	Range	Description
Destination address	Multicast: 224.0.0.0 ~239.255.255.255 Unicast: terminal IP address	
Destination port	1~65535	
Total Bitrate	0 – 30000Kbps	Need to be higher than the video bitrate

2. RTP

Settings	Range	Description
Destination address	Multicast: 224.0.0.0 ~239.255.255.255 Unicast: terminal IP address	
Destination port	1~65535	
Total Bitrate	0 – 30000Kbps	Need to be higher than the video bitrate

Video setting

Below the capture shows the parameters that the user could configure transcoding parameters for video output. Different transport protocol will have different config parameters.

Output							
Total Bitrate(Mbps)	Encoding Format	Video Bitrate(Mbps)	Resolution	Frame Rate	Data Table Standard	Data Table Mode	Closed Caption
11.00	MPEG-2	10.00	1920 x 1080	Auto	DVB	Disable	Disable
8.80	MPEG-2	8.00	1920 x 1080	Auto	ATSC	Disable	Disable
8.80	MPEG-2	8.00	1920 x 1080	Auto	ATSC	Disable	Disable
8.80	MPEG-2	8.00	1920 x 1080	Auto	ATSC	Disable	Disable
8.80	MPEG-2	8.00	1920 x 1080	Auto	ATSC	Disable	Disable
8.80	MPEG-2	8.00	1920 x 1080	Auto	ATSC	Disable	Disable
8.80	MPEG-2	8.00	1920 x 1080	Auto	ATSC	Disable	Disable
8.80	MPEG-2	8.00	1920 x 1080	Auto	ATSC	Disable	Disable
8.80	MPEG-2	8.00	1920 x 1080	Auto	ATSC	Disable	Disable
8.80	MPEG-2	8.00	1920 x 1080	Auto	ATSC	Disable	Disable
8.80	MPEG-2	8.00	1920 x 1080	Auto	ATSC	Disable	Disable

Settings	Range	Description
Encoding format	MPEG-2 H.264 H.265(License required)	
Bitrate	0.48-20Mbps	Video bitrate
Resolution	Auto 1920 x 1080 1280 x 720 720 x 576 720 x 480	When choose "Auto", it would follow the original video resolution
Frame Rate	Auto 25p/29.97p/30p/50p/ 59.94p/60p 25i/29.97i/30i/50i/59. 94i/60i	When choose "Auto", it would follow the original video frame rate.
Data Table Standard	DVB/ATSC	
Data Table Mode	Disable Passthrough Generate	User could select if you need to disable, passthrough or generate the table on CX-TXS-00 which including ATSC,NIT and EIT table
Closed Caption	Enable Disable	Choose if use the closed caption on the output

Audio Setting

This section allows the user to configure transcoding parameters of audio output. Different transport protocol will have different config parameters

Audio1 Codec	Audio1 Bitrate(Kbps)	Audio1 Sample Rate(Khz)	Audio1 Language
MPEG1/L2	96	48	1
MPEG1/L2	96	48	1
MPEG1/L2	96	48	1
MPEG1/L2	96	48	1
MPEG1/L2	96	48	1
MPEG1/L2	96	48	1
MPEG1/L2	96	48	1
MPEG1/L2	96	48	1
MPEG1/L2	96	48	1
MPEG1/L2	96	48	1

Subtitle Setting

Subtitle1 Codec	Subtitle1 Input ID
None	1
None	1
None	1
None	1
None	1
None	1
None	1
None	1
None	1
None	1

CX-TXS-00 >System

Network

As shown below, CX-TXS-00 has 2 Data ports and the internal port would be used for data input/output. The Link Status shows if user connect the cable into the Data port. User could change

the IP Address, Subnet Mask and DNS for each Data port. After configuring the parameters, click **Apply** button.

Network	IP Address	Subnet Mask	Default Gateway	Primary DNS	Secondary DNS	MAC Address	Link Status
Data 1	192.168.13.167	255.255.255.0	192.168.13.254	10.100.20.7	10.100.20.10	a0:69:86:06:da:fb	● 100Mb/s
Data 2	192.168.2.211	255.255.255.0	192.168.2.254			a0:69:86:06:da:fc	● 1000Mb/s
Internal	192.168.1.13	255.255.255.0	192.168.1.254			a0:69:86:06:da:fd	● 1000Mb/s

Apply

Settings	Range	Description
IP Address	xxx.xxx.xxx.xxx	Static mode IP address entry
Subnet Network	xxx.xxx.xxx.xxx	Static Mode subnet mask entry
Gateway	xxx.xxx.xxx.xxx	Static Mode gateway entry

Vlan

To add a VLAN to the NIC, click the **+ VLAN** icon to add the VLAN. After clicking **Save** to finish configuring the newly created VLAN, it will appear on the VLAN list as seen in the figure below. To remove individual VLANs, click the blue icon **Delete** in the corresponding row.

Network	VLAN ID	VLAN IP	Operation
Data 1	1	192.168.1.1	Save Delete

Settings	Available Selections	Description
Network	Data0/Data1/Internal	Add the VLAN to the designated NIC
VLAN ID	1-4094	The VLAN tag to be assigned to outgoing streams and filtered for incoming streams
VLAN IP	xxx.xxx.xxx.xxx	Static mode IP address entry

Firmware Version Upgrade

Updates to the CX-TXS-00 are performed through the web interface. A firmware upgrade file is provided by Wellav and then uploaded to the unit. To request the latest firmware version or a copy of the release notes please contact our after-sales technical support team.

Firmware Version Update

Upgrade

Software License

Every CX-TXS-00 modules would have its own Product ID. If user need to renew the license file or add the license feature, please export the license file and send it to Wellav after-sales technical support team.

Software License

Product ID: f0acf4faa47942e7c4114c9436c6d48b

Import License

Export License

System Resource

This page shows the current usage for the CPU, Memory and GPU. With different transcode channels, different transcoding parameters and different transcoding configuration, the usages are also different.

System Resource

CPU Usage		5%
Memory Usage		7.78%
GPU Usage		0%

Profile

The CX-TXS-00 is able to save all configured settings to multiple profiles. Profiles can be saved locally and saved to external storage to be used on other CX-TXS-00 modules or do a backup for the current module. Profiles can be used to quickly and easily change the configuration of the module to suit different inputs and decoding requirements.

Profile

Profile Name	Date	Operation
2023_03_12_15_49_54.sys.img	2023-03-12 15:49:54	Apply Download Delete

[Import Profile](#)
[Backup Profile](#)

Backup New Profile	Backup Profile	Used to create a new profile to the profile list
Import Profile	Import Profile	Used to import a profile to the module from user pc
Apply Profile	Apply	Used to apply a profile selected from profile list
Download Profile	Download	Used to download a profile selected from the list to the user pc
Delete Profile	Delete	Used to delete a profile from the profiles list

SNMP

User is allowed to manage CX-TXS-00 system via SNMP MIB file. After finished configuration, click



SNMP	Password	IP
Read-Only Community	<input type="text" value="public"/>	<input type="text" value="default"/>
Read-Write Community	<input type="text" value="private"/>	<input type="text" value="default"/>

[Apply](#)

System Restart

User can reboot system, reset system to defaults and turn off system through Web operation on this section.

Noted: IP addresses will not change when reset system to defaults.



Logs

Generally, the original system logs will be saved for several months until it is covered by new logs if the system is running normally. It recommends the user to save and send current system logs to the technician of Wellav if the system runs abnormally.

There are Real-time logs inside the box which would keep a small part of the latest log. If user need to observe the Real-time logs without exporting the log file, click [Clear Log](#). The unit would keep generating the new logs inside the box.

Logs

```

2023-03-12 11:57:39 [Alarm] ID:00030002, Description:Channel[1] Source Signal that the input signal is lost, Solution:Check the input signal
2023-03-12 12:00:49 [Alarm] Description:Channel[1] Source recovery
2023-03-12 12:00:49 [Alarm] ID:00040003, Description:Stop Channel[1] Signal that the encoding channel is stopped, Solution:Notice
2023-03-12 12:00:50 [Alarm] ID:00030002, Description:Channel[1] Source Signal that the input signal is lost, Solution:Check the input signal
2023-03-12 12:04:01 [Alarm] Description:Channel[1] Source recovery
2023-03-12 12:04:01 [Alarm] ID:00040003, Description:Stop Channel[1] Signal that the encoding channel is stopped, Solution:Notice
2023-03-12 12:04:02 [Alarm] ID:00030002, Description:Channel[1] Source Signal that the input signal is lost, Solution:Check the input signal
2023-03-12 12:07:12 [Alarm] Description:Channel[1] Source recovery
2023-03-12 12:07:12 [Alarm] ID:00040003, Description:Stop Channel[1] Signal that the encoding channel is stopped, Solution:Notice
2023-03-12 12:07:14 [Alarm] ID:00030002, Description:Channel[1] Source Signal that the input signal is lost, Solution:Check the input signal
2023-03-12 12:10:24 [Alarm] Description:Channel[1] Source recovery
2023-03-12 12:10:24 [Alarm] ID:00040003, Description:Stop Channel[1] Signal that the encoding channel is stopped, Solution:Notice
2023-03-12 12:10:25 [Alarm] ID:00030002, Description:Channel[1] Source Signal that the input signal is lost, Solution:Check the input signal
2023-03-12 12:13:36 [Alarm] Description:Channel[1] Source recovery
2023-03-12 12:13:36 [Alarm] ID:00040003, Description:Stop Channel[1] Signal that the encoding channel is stopped, Solution:Notice
2023-03-12 12:13:37 [Alarm] ID:00030002, Description:Channel[1] Source Signal that the input signal is lost, Solution:Check the input signal
2023-03-12 12:16:47 [Alarm] Description:Channel[1] Source recovery
2023-03-12 12:16:47 [Alarm] ID:00040003, Description:Stop Channel[1] Signal that the encoding channel is stopped, Solution:Notice
2023-03-12 12:16:49 [Alarm] ID:00030002, Description:Channel[1] Source Signal that the input signal is lost, Solution:Check the input
    
```

[Clear Log](#)
[Export Log](#)
[Export System Log](#)

CX-TXS-00 >Alarm

This page displays all of the current active alarms being reported by the unit. Click [Ignore](#) to conceal alarms.

CX2-TXS-00					
					Status Input Engine System Alarm About
NO.	Location	Alarm Type	Last Changed	Notification	Operation
1	IPI-0(udp://239.192.10.201:10000>Data 2)pat error.	TS packet pat error	2023/03/12 17:01:02	Please check the input	Ignore
2	IPI-0(udp://239.192.10.201:10000>Data 2)pat table error.	TS packet pat error 1	2023/03/12 17:01:05	Please check the input	Ignore

CX-TXS-00 >About

User can check the product ID and fingerprint of the unit, also with firmware version currently installed.

CX2-TXS-00

Status Input Engine System Alarm [About](#)

Information

Product ID:	f0acf4faa47942e7c4114c9436c6d48b
Firmware Name:	release
Firmware Version:	1.5.2
Hardware Version:	1.0.0.0
Build Version:	10271
Release Date:	2023-03-01 23:42:35
Hardware Fingerprint:	5d0e1794e40f208e6e762c97ef36b434

5.6 Decode Module

5.6.1 CD2-SDI-00

CD2-SDI-00 is a 4-channel SDI decoding board with 4-channel HD/SD SDI decoding and output, supporting H.265/H.264/Mpeg-2/AVS2/AVS+ video and Mpeg-1 Layer II/AAC (optional)/AC-3 audio format decoding.



Click the **Status** in the menu to go into status page where you can see **IP input Status, Decode Status**.

CD-SDI-00 Status Input Decode System Setting

IP Input Status Decode Status

Total Bitrate: 9.843 Mbps

Channel	IP Address : Port	Status	Effective Bitrate(Mbps)	Total Bitrate(Mbps)	TS Analysis	Service List
1.1	227.10.20.31 : 10000	●	9.105	9.843	👁	☰
1.2	0.0.0.0 : 0	●	0.000	0.000	👁	☰
1.3	0.0.0.0 : 0	●	0.000	0.000	👁	☰
1.4	0.0.0.0 : 0	●	0.000	0.000	👁	☰

Status > IP input Status

In this page, you can check info of each channel: **Effect Bit Rate, Total Bit Rate, TS Analysis and Service List.**

CD-SDI-00 Status Input Decode System Setting

IP Input Status Decode Status

Total Bitrate: 10.001 Mbps

Channel	IP Address : Port	Status	Effective Bitrate(Mbps)	Total Bitrate(Mbps)	TS Analysis	Service List
1.1	227.10.20.31 : 10000	●	9.252	10.001	👁	☰
1.2	0.0.0.0 : 0	●	0.000	0.000	👁	☰
1.3	0.0.0.0 : 0	●	0.000	0.000	👁	☰
1.4	0.0.0.0 : 0	●	0.000	0.000	👁	☰

Click the icon (👁) in the **TS Analysis** list to see the TS analyzing result of each channel. Click the icon (☰) in the **Service List** to see the Services of each channel.

- TS Analysis

Click **Reset Counter** to clear continuity count errors and restart counting. Fill in the search bar with key words of PID / Bit rate / bandwidth / table type / service name to get info you want.

Channel 1.1 TS Analysis Reset Counter

Search 🔍

PID	Bitrate(Mbps)	Bandwidth(%)	Continuity Count Error	Type	Service
0x0(0)	0.019	0.192	127	PAT	
0x11(17)	0.019	0.192	127	SDT	
0x23(35)	0.195	1.969	0	Audio	td HD Phx Chinese Channel
0x24(36)	8.911	89.956	127	PCR, Video	td HD Phx Chinese Channel
0x25(37)	0.019	0.192	127	PMT	td HD Phx Chinese Channel

- Service List

Click a service name to check its detailed info.

[2] td HD Phx Chinese Channel

Type	PID	Bitrate(Mbps)
PCR	36(0x24)	9.141
PMT	37(0x25)	0.018
Audio	35(0x23)	0.202
Video(H264)	36(0x24)	9.141

Close

Status >Decode Status

In this page, you can check info of each channel: **Source,Service,Video Foramt,Video Info and Audio Info.**

CD-SDI-00 Status Input Decode System Setting

IP Input Status Decode Status

Channel	Status	Source	Service	Video			Audio
				Native Format	Output Format	Video Info	Audio Info
1	●	17.1.2	1 (Service01)	400x300p 16x9 30.00fps	720x480i 1x1 29.97fps	PID:256 (H.264)	PID:257 (MPEG2 AAC --kbps --kHz)
2	●	None	None	--	--	--	--
3	●	None	None	--	--	--	--
4	●	None	None	--	--	--	--

IP Input >Basic Setting

Here you can configure IP input parameters: **Destination IP Address, Destination Port, Protocol (UDP/RTP), TS Packets Per IP Packet,Input Processing Mode**,Click **Apply** to make the setting take effect.

CD-SDI-00 Status **Input** Decode System Setting

Basic Setting Service Configuration

Batch Setting ^

Select All Enable Protocol

Start Channel-End Channel: 1 - 4

Destination IP Address: 227.10.20.80 Same

Destination Port: 1234 Same

Pkt Length: 7

Batch Setting Apply

Channel	Enable	Destination IP Address	Destination Port	Protocol	Pkt Length	Input Processing Mode
1.1	<input checked="" type="checkbox"/>	227.10.20.100	10000	UDP	Auto	CBR
1.2	<input type="checkbox"/>	227.20.30.2	1234	UDP	Auto	CBR
1.3	<input type="checkbox"/>	227.20.30.3	1234	UDP	Auto	CBR
1.4	<input type="checkbox"/>	227.20.30.4	1234	UDP	Auto	CBR

There are two methods of IP input here:

- First, using the baseboard as an example (*Same as other receiver board without service configuration*): Setting the IP input on the baseboard, transmits IP input streams on the baseboard to the switch, CD2-SDI-00 receives streams from the switch.

➤ Baseboard Setup

Status **Input** Output System

Input **Status** IP Setting IGMP Setting

Total Bitrate: 12.348 Mbps

Channel	IP Address: Port	Status	Effective Bitrate(Mbps)	Total Bitrate(Mbps)	TS...	Servi...
1.1	227.10.20.31 : 10000	●	2.251	2.347	👁	☰
1.2	239.192.10.224 : 10000	●	9.436	10.001	👁	☰
1.3	227.110.110.11 : 10000	●	0.000	0.000	👁	☰

➤ CD2-SDI-00 Setup

CD2-SDI-00 Status **Input** De

Basic Setting

atch Setting ▾

< 1 >

Channel	Enable	Destination IP Address	Destination Port	Protocol	Pkt Length	Input Processing
1.1	<input checked="" type="checkbox"/>	227.10.20.31	10000	UDP	Auto	CBR
1.2	<input checked="" type="checkbox"/>	239.192.10.224	10000	UDP	Auto	CBR

➤ CD2-SDI-00 Status

CD-SDI-00 Status Input Decode System Setting

IP Input Status Decode Status

Total Bitrate: 10.001 Mbps

Channel	IP Address: Port	Status	Effective Bitrate(Mbps)	Total Bitrate(Mbps)	TS Analysis	Service List
1.1	227.10.20.31 - 10000	●	9.252	10.001	👁	☰
1.2	0.0.0.0 - 0	●	0.000	0.000	👁	☰
1.3	0.0.0.0 - 0	●	0.000	0.000	👁	☰
1.4	0.0.0.0 - 0	●	0.000	0.000	👁	☰

- Second, using the baseboard as an example (*Same as other receiver board have service configuration*): Configure the program on the baseboard to go to CD2-SDI-00.

➤ Baseboard Setup

Status **Input** Output System Setting agent

Input Status IP Setting IGMP Setting **Service Configuration**

Channel Select: Channel 1.1 Scanning Time(ms): 1000 PSI Search Time(ms): 5000 **Program Scan**

Program Clear

Service Name	Destination	Destination Setting
> Channel 1.1 +		⚙
▾ Channel 1.2 +	2.CD2-SDI-00[1.1]	⚙
[1] Program0		✎
PID 17 (Other PID)		✎
> Channel 1.3 +		⚙

Apply
Clear Config

➤ In CD2-SDI-00 Decode page can pick the service program

➤ Decode Status

CD2-SDI-00 supports transport with the following protocols: UDP, RTP.

1. UDP

Settings	Range	Description
Destination address	Multicast: 224.0.0.0 ~239.255.255.255 Unicast: terminal IP address	
Destination port	1~65535	
Total Bitrate	0 – 30000Kbps	Need to be higher than the video bitrate

2. RTP

Settings	Range	Description
Destination	Multicast:	

address	224.0.0.0 ~239.255.255 .255 Unicast: terminal IP address	
Destination port	1~65535	
Total Bitrate	0 – 30000Kbps	Need to be higher than the video bitrate

3.Other Setting

Settings	Range	Description
Pkt Length	Auto 1– 7	It represents the length or size of packets transmitted in network communication.
Input Processing Mode	CBR VBR Dejittering-C BR	CBR:Constant Bit Rate.The transmitted data stream is sent or encoded at a constant bit rate. VBR:Variable Bit Rate.The encoder automatically adjusts the bit rate according to the characteristics of the audio or video content to provide the best encoding quality for each time period. Dejittering-CBR:Using CBR to transmit or encode data, using jitter technology to reduce or eliminate the timing instability caused by jitter.

If you want to configure a batch of channels, please click [Batch Setting](#)

To set the IP input parameters in batch, you can check the boxes before parameters you need then choose / modify the values. Click **Apply** to make the setting take effect.

CD-SDI-00 Status **Input** Decode System Setting

Basic Setting **Service Configuration**

Batch Setting ^

Select All Start Channel-End Channel -

Enable Destination IP Address

Protocol Destination Port

Pkt Length Pkt Length

[Batch Setting](#)

[Apply](#)

Channel	Enable	Destination IP Address	Destination Port	Protocol	Pkt Length	Input Processing Mode
1.1	<input checked="" type="checkbox"/>	<input type="text" value="227.10.20.100"/>	<input type="text" value="10000"/>	<input type="text" value="UDP"/>	<input type="text" value="Auto"/>	<input type="text" value="CBR"/>
1.2	<input type="checkbox"/>	<input type="text" value="227.20.30.2"/>	<input type="text" value="1234"/>	<input type="text" value="UDP"/>	<input type="text" value="Auto"/>	<input type="text" value="CBR"/>
1.3	<input type="checkbox"/>	<input type="text" value="227.20.30.3"/>	<input type="text" value="1234"/>	<input type="text" value="UDP"/>	<input type="text" value="Auto"/>	<input type="text" value="CBR"/>
1.4	<input type="checkbox"/>	<input type="text" value="227.20.30.4"/>	<input type="text" value="1234"/>	<input type="text" value="UDP"/>	<input type="text" value="Auto"/>	<input type="text" value="CBR"/>

IP Input >Service Configuration

To stream a source stream, you can configure the destination in this page.Can also configure to CD2-SDI-00 to give decoding

CD-SDI-00 Status **Input** Decode System Setting

Basic Setting **Service Configuration**

Channel Select: Scanning Time(ms): SI Search Time(ms): [Program Scan](#) [Program Clear](#)

Service Name	Destination	Destination Setting
▼ Channel 1.1	12.CD-SDI-00[1.1]	
[1] Wellav service		
▼ Channel 1.2	12.CD-SDI-00[1.2]	
[1] Service01		
▼ Channel 1.3	12.CD-SDI-00[1.3]	
[1] Thairath HD		
▼ Channel 1.4	12.CD-SDI-00[1.4]	
[1] Program0		

[Apply](#)
[Clear Config](#)

- Multiplex or Bypass stream: Click the setting icon (), check the output module, and then you can set the output channel of this stream. After you select bypass mode, this output channel will be occupied only by this stream.
- Multiplex services: You should click the service line setting icon () to make the certain service output from certain channel combining with other services. The operation you can refer to multiplex stream output.

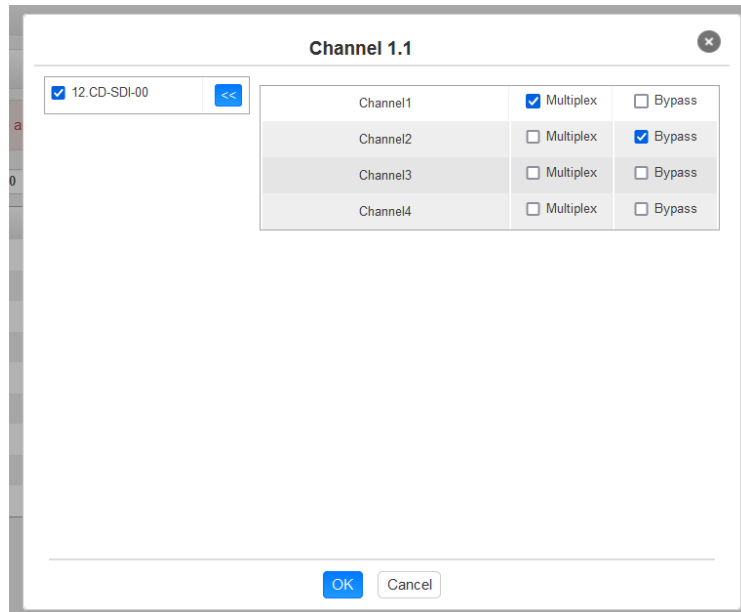

After setting the output destination, click **Apply** to make it take effect. The destination channel will be displayed in the channel/service line. And you can also click **Clear Configuration** to clear all of the configuration.



There is a channel scan button (Channel Scan) on top. Normally the input service list of each channel will load itself on this page, but when you change the input source, the list could not refresh immediately. You can refresh the changed channels manually by selecting the channel and clicking the channel scan button.

Decode

Here you can configure decode parameters: **Service, Audio, Format Mode, Audio State, Audio Volume**.

Decode the programs coming from the various boards.

CD2-SDI-00
Status Input Decode System Setting

⚙️ Advanced Setting >

Channel	Service Select		Processing				Clear Service
	Service	Audio	Format Mode	Manual Format	Audio State	Audio Volume	
1	[17.1.2] Program0 (Service ID: 1)	4112	Automatic	720x480i 16x9 29.97fps	Enable	100	✖
2	None	None	Automatic	720x480i 16x9 29.97fps	Enable	100	✖
3	[17.1.2] Program0 (Service ID: 1)	None	Automatic	720x480i 16x9 29.97fps	Enable	100	✖
4	None	None	Automatic	720x480i 16x9 29.97fps	Enable	100	✖

Apply

Decode Setting

Settings	Range	Description
Audio	None digital	Audio format
Format Mode	Automatic Manual	Select resolution
Audio State	Enable Disable	
Audio Volume	0–100	

6 Appendices

Appendix A – Power Consumption

CMP100 Power supply	350W
CMP201AD/201A/203A Power supply	400W
CMP201/201D/203 Power supply	200W
CMP201 Chassis	Max.21W
CMP201AD Chassis	Max.45W
CMP201A Chassis	Max.44W
CMP201D Chassis	Max.23W
CMP203 Chassis	Max.37W
CMP203A Chassis	Max.59W
CMP100 Chassis	Max.72W
CR2-DVBC-00:DVBC AnnexA/C	Max.9W
CR2-DVBC-00:DTMB	Max.9W
CR2-DVBC-01:DVBC AnnexB	Max.9W
CR2-DVBC-01:ISDB-T	Max.9W
CR2-DVBS2FTA-01	Max.38W
CR2-DVBS2FTA-01A	Max.70W
CR2-DVBS2CI-01	Max.22W
CR2-DVBT2CI-00	Max.8W
CR2-8VSB-00	Max.9.5W
CM2-8VSB-R01/R01A	4CH: Max.12W; 8CH: Max.14W

CM2-DTMB-R01/R01A	4CH: Max.12W; 8CH: Max.14W
CM2-OFDM-R01/R01A	4CH: Max.12W; 8CH: Max.14W
CM2-QAMB-R01/R01A	4CH: Max.12W; 8CH: Max.14W
CM2-QAMA-R01/R01A	4CH: Max.12W; 8CH: Max.14W
CM2-ISDBT-R01/R01A	4CH: Max.12W; 8CH: Max.14W
CM2-QAMA-02/02A	Max. 41W
CM2-DTMB-03	Max.23W
CM2-QAMA-03	Max.24W
CM2-QAMB-03	Max.23W
CM2-OFDM-03	Max.23W
CM2-ISDBT-03	Max.23W
CM2-8VSB-03	Max.23W
CM2-QAMB-02A	Max.41W
CM2-QAMA/B-R00	Max.21W
CE2-HDMI-R01	Max.12W
CE2-HDMI-02C	Max.17W
CE2-HDMI-02	Max.17W
CE2-HDMI-05A	Max.21W
CE2-HDMI-R05	Max.19W
CE2-HDMI-06	Max.20W
CE2-SDI-01	Max.16W
CE2-CVBS-00	Max.17W
CE2-CVBS-R01	Max.18W
CP2-EAS-00	Max.5.5W

CP2-IP-00	Max.16W
CP2-IP-02	Max.9W
CP2-ASI-00	Max.8W
CP2-EIT-00	Max.5W
CP2-CAM-00	Max.6W
CX2-TXS-00	Max.49W
CD2-SDI-00	Max.25W

Comments: The chassis includes both the baseboard's and fan's

Appendix B – Abbreviations

8VSB	Vestigial sideband modulation with 8 discrete amplitude levels
16VSB	Vestigial sideband modulation with 16 discrete amplitude levels
AAC	Advanced Audio Coding
AC-3	Also known as Dolby Digital
ASI	Asynchronous Serial Interface
ATSC	Advanced Television Systems Committee
AV	Audio Video
BAT	Bouquet Association Table
BER	Bit Error Ratio
Bit Rate	The rate at which the compressed bit stream is delivered
BNC	British Naval Connector
CAM	Conditional Access Module
CAT	Conditional Access Table
CAT6	Category 6 – Cable standard for gigabit Ethernet

CBR	Constant Bitrate
CI	Common Interface
CVBS	CompositeVideoBroadcastSignal
CC	Closed Caption
dB	Decibel
DVB	Digital Video Broadcasting
EIT	Event Information Table
EPG	Electronic Program Guide
FEC	Forward Error Correction
GOP	Group of Pictures
HD	High Definition
HDCP	High-bandwidth Digital Content Protection
HDMI	High Definition Multimedia Interface
	The terms HDMI, HDMI High-Definition Multimedia Interface, and the HDMI Logo are trademarks or registered trademarks of HDMI Licensing Administrator, Inc.
I/O	Input/output
Kbps	1000 bit per second
LCN	Logical Channel Number
LNB	Low-Noise Block
LO	Local Oscillator
Mbps	1,000,000 bits per second
MER	Modulation Error Ratio
MIB	Management Information Base
MPTS	Multi-program Transport Stream
NIT	Network Information Table
OFDM	Orthogonal Frequency-Division Multiplexing
PAT	Program Association Table
PCR	Program Clock Reference

PID	Packet Identifier
PMT	Program Map Table
PSI	Program Specific Information
PSU	Power Supply Unit
QAM	Quadrature Amplitude Modulation
QPSK	Quadrature Phase-Shift Keying
SD	Standard Definition
SDI	Serial Digital Interface
SDT	Service Description Table
SI	Service Information
SNMP	Simple Network Management Protocol
SNR	Signal Noise Ration
SPTS	Single Program Transport Stream
TDT	Time and Date Table
TS	Transport Stream
VBR	Variable Bitrate

Appendix C- Warranty

We warrants this instrument against defects from any cause, except acts of God and abusive use, for a period of 1 (one) year from date of purchase. During this warranty period, we will correct any covered defects without charge.

Appendix D- After-Sales Support

Please contact our sales/regional representatives for any help, product information, and troubleshooting.

Returning Products for Service

The CMP201A is a delicate piece of equipment and needs to be serviced and repaired by the manufacturer. In order to expedite this process please carefully read the following items.

- Confirm the required component

Before any product can be returned for service, the client ought to contact our sales representatives and after-sales support department by means of email to confirm the need to return the product or parts of the product.

- Collect the Serial Numbers to obtain RMA Number

Serial Number (SN) is printed on a label on the chassis and modules. To create a RMA number, SN must be submitted to support department. Once the RMA number has been issued to the client, the unit/component needs to be packaged and shipped back to the manufacturer. It's best to use the original box and packaging for the product but if this not available, check with the service department for the proper packaging instructions. RMA Number should be specified in the delivery bill or written on the package.



Do not return any power cables or accessories unless instructed to do so.